

# MDS™ ORBIT MCR

## Multiservice Connect Router



# MDS™ ORBIT ECR

## Edge Connect Router



MDS 05-6632A01, Rev. F  
May 2016

*Including New Features from Firmware Revision 4.6.x*



View instructional videos: [Orbit™ MCR Learning and Development YouTube Channel](#)



Quick-Start instructions for this product are contained in publication 05-6709A01.  
Visit our website for downloadable copies of all documentation at [www.gemds.com](http://www.gemds.com).



# TABLE OF CONTENTS

<b>COPYRIGHT AND TRADEMARK</b> .....	<b>7</b>
<b>RF REGULATORY INFORMATION</b> .....	<b>7</b>
<b>SAFETY REGULATORY INFORMATION – (REGION-SPECIFIC)</b> .....	<b>10</b>
<b>PRODUCT COUNTRY CERTIFICATION INFORMATION – (NON-NA/EU)</b> .....	<b>13</b>
<b>1.0 PRODUCT OVERVIEW AND APPLICATIONS</b> .....	<b>16</b>
1.1 INTRODUCTION .....	16
1.1.1 PRODUCT VARIATIONS.....	16
1.1.2 ABOUT THIS MANUAL .....	17
<b>2.0 PRODUCT DESCRIPTION</b> .....	<b>19</b>
2.1 KEY FEATURES.....	19
2.2 INTERFACE TYPES .....	19
2.3 NETWORK INTERFACE CARDS (NICs) .....	19
2.3.1 4G LTE/CDMA (VERIZON ONLY).....	19
2.3.2 4G LTE, HSPA+, GSM/GPRS (EMEA/APAC) .....	20
2.3.3 4G LTE, HSPA+, GSM/GPRS (NORTH AMERICA).....	20
2.3.4 3G CELL .....	20
2.3.5 900 MHZ UNLICENSED .....	20
2.3.6 LICENSED NARROWBAND .....	21
2.4 TYPICAL APPLICATIONS.....	22
2.5 MCR AND ECR CONNECTORS AND INDICATORS .....	22
2.6 GROUNDING CONSIDERATIONS.....	28
2.7 MOUNTING OPTIONS .....	29
2.7.1 OPTIONAL DIN RAIL MOUNTING .....	30
2.8 ANTENNA PLANNING AND INSTALLATION.....	31
<b>3.0 DEVICE MANAGEMENT</b> .....	<b>36</b>
3.1 INITIAL SETTINGS OVERVIEW .....	39
3.1.1 SETTING BASIC PARAMETERS—FIRST STEPS .....	39
3.1.2 ONE-TIME “RECOVERY” PASSWORDS .....	39
3.1.3 CHANGE DEFAULT PASSWORDS .....	42
3.1.4 SECURITY REVIEW .....	43
3.2 PRECONFIGURED SETTINGS .....	44
3.3 SPECIFIC APPLICATION EXAMPLES USING DEVICE MANAGER.....	45
3.4 USING THE COMMAND LINE INTERFACE (CLI).....	51
3.4.1 DIFFERENCES BETWEEN SERIAL AND SSH .....	51
3.4.2 ESTABLISHING COMMUNICATION—SERIAL INTERFACE .....	51
3.4.3 USING THE CLI .....	52
3.4.4 CLI QUICK REFERENCE TABLE .....	53
3.4.5 SPECIFIC EXAMPLES USING CLI .....	55
3.5 INTERFACE CONFIGURATION.....	59
3.5.1 SERIAL INTERFACE .....	59
3.5.2 CELL.....	64
3.5.3 WiFi.....	78



3.5.4	UNLICENSED 900 MHz ISM (NX915).....	93
3.5.5	LICENSED NARROWBAND (LN) .....	124
3.6	SYSTEM HEALTH AND STATUS .....	146
3.6.1	DEVICE OVERVIEW .....	146
3.6.2	EVENT LOGGING .....	146
3.6.3	IPERF SERVER SERVICE .....	153
3.6.4	SNAPSHOTS AND SYSTEM RECOVERY .....	155
3.6.5	SUPPORT BUNDLE.....	160
3.7	SYSTEM CONFIGURATION AND SETUP .....	162
3.7.1	DATE, TIME AND NTP .....	162
3.7.2	GEOGRAPHICAL-LOCATION.....	165
3.7.3	USER MANAGEMENT AND ACCESS CONTROLS .....	165
3.7.4	RADIUS USER MANAGEMENT .....	169
3.7.5	FIRMWARE MANAGEMENT .....	171
3.7.6	TAMPER DETECTION.....	179
3.7.7	CONFIGURATION FILES .....	182
3.7.8	DNS.....	186
3.8	NETWORKING SERVICES AND ROUTING.....	189
3.8.1	NETWORK .....	189
3.8.2	LAN .....	193
3.8.3	ETHERNET PORT SECURITY / PORT-BASED AUTHENTICATION.....	199
3.8.4	VLAN OPERATION .....	200
3.8.5	BRIDGING.....	203
3.8.6	ROUTING.....	206
3.8.7	STATIC NEIGHBOR ENTRIES .....	211
3.8.8	ACCESS CONTROL LIST (PACKET FILTERING / FIREWALL).....	214
3.8.9	SOURCE NAT (MASQUERADING) .....	226
3.8.10	DESTINATION NAT (PORT FORWARDING) .....	234
3.8.11	STATIC NAT.....	241
3.8.12	VPN.....	245
3.8.13	DHCP SERVICE .....	264
3.8.14	TERMINAL SERVICE .....	268
3.8.15	REMOTE MANAGEMENT INTERFACES.....	276
3.8.16	REMOTE MANAGEMENT SERVICE .....	281
3.8.17	QUALITY OF SERVICE (QoS) .....	290
3.8.18	SNMP.....	300
3.8.19	NETWORK MONITOR SERVICE .....	320
3.8.20	NETWORK LINK FAILOVER/FAILBACK .....	322
3.8.21	DYNAMIC ROUTING.....	342
3.8.22	GPS SERVICE .....	355
3.8.23	DYNAMIC DNS .....	357
3.8.24	VRRP – VIRTUAL ROUTER REDUNDANCY PROTOCOL .....	360
3.8.25	IP PASSTHROUGH.....	362
3.9	PUBLIC KEY AND CERTIFICATES.....	364
3.9.1	CERTIFICATE MANAGEMENT AND 802.1X AUTHENTICATION.....	364



3.9.2	PRIVATE KEYS .....	364
3.9.3	CA CERTIFICATES.....	368
3.9.4	CLIENT CERTIFICATES .....	371
3.9.5	FIRMWARE CERTIFICATES .....	375
3.9.6	SCEP AND CA CONFIGURATION .....	378
<b>4.0</b>	<b>TECHNICAL REFERENCE .....</b>	<b>381</b>
4.1	TROUBLESHOOTING .....	381
4.1.1	LED STATUS INDICATORS.....	381
4.2	TECHNICAL SPECIFICATIONS .....	383
<b>5.0</b>	<b>GLOSSARY OF TERMS AND ABBREVIATIONS.....</b>	<b>390</b>
<b>6.0</b>	<b>APPENDIX A – COMMAND LINE INTERFACE (CLI) FEATURES .....</b>	<b>394</b>
6.1	OPERATIONAL MODE .....	394
6.2	CONFIGURATION MODE.....	394
6.3	CHANGING CONFIGURATION DATA .....	394
6.4	INPUTTING VALUES .....	394
6.5	INPUT OF A LIST OF VALUES .....	394
6.6	TAB-COMPLETION.....	395
6.7	CLI ENVIRONMENT .....	396
6.8	COMMAND OUTPUT PROCESSING .....	397
6.9	COUNT THE NUMBER OF LINES IN THE OUTPUT .....	398
6.10	SEARCH FOR A STRING IN THE OUTPUT.....	398
6.11	REGULAR EXPRESSIONS .....	399
6.12	DISPLAY LINE NUMBERS.....	399
6.13	SHOWING INFORMATION.....	400
6.14	CONTROL SEQUENCES.....	400
6.15	COMMANDS .....	400
6.16	OPERATIONAL MODE COMMANDS .....	401
6.17	CONFIGURE MODE COMMANDS .....	404
<b>7.0</b>	<b>APPENDIX B – INTEGRITY MEASUREMENT AUTHORITY (IMA) .....</b>	<b>408</b>
7.1	UNDERSTANDING .....	408
7.2	CONFIGURING.....	408
7.2.1	OBTAINING CONFIGURATION FILE HASH .....	409
7.3	MONITORING .....	409
7.4	IMA TROUBLESHOOTING .....	410
<b>8.0</b>	<b>APPENDIX C – COMMON EVENT EXPRESSION (CEE).....</b>	<b>411</b>
8.1	EVENT TAXONOMY.....	411
8.2	EVENT FIELD DICTIONARY .....	411
8.3	EVENT ENCODING & TRANSPORT .....	412
8.3.1	EXAMPLES.....	412
8.3.2	SYSLOG PRIVAL .....	413
8.3.3	SYSLOG APP-NAME .....	413
8.3.4	SYSLOG MSG.....	413
8.4	CONFIGURING.....	413



8.5	MONITORING .....	414
<b>9.0</b>	<b>APPENDIX D – MANAGING SIGNED FIRMWARE .....</b>	<b>415</b>
<b>10.0</b>	<b>APPENDIX E – OBTAINING PROVISIONED 4G/LTE SERVICE (VERIZON).....</b>	<b>417</b>
10.1	UNDERSTANDING .....	417
10.2	BEFORE CONTACTING VERIZON.....	417
10.3	ESTABLISHING A CELL SERVICE PLAN.....	417
<b>11.0</b>	<b>APPENDIX F – NX915 MODULE FREQUENCIES.....</b>	<b>418</b>
<b>12.0</b>	<b>APPENDIX G- VPN CONFIGURATION EXAMPLES.....</b>	<b>421</b>
12.1	POLICY-BASED IPSEC VPN WITH JUNIPER JUNOS.....	421
12.1.1	ORBIT.....	421
12.1.2	JUNOS.....	424
12.2	DMVPN WITH CISCO IOS.....	425
12.2.1	ORBIT.....	426
12.2.2	CISCO IOS.....	432
12.3	GRE/IPSEC WITH JUNIPER JUNOS.....	437
12.3.1	ORBIT.....	437
12.3.2	JUNOS.....	441
<b>13.0</b>	<b>APPENDIX H – 802.1X PORT AUTHENTICATION W/ EAP.....</b>	<b>446</b>
13.1	OVERVIEW.....	446
13.2	CONFIGURATION EXAMPLES.....	446
13.2.1	ORBIT DEVICE .....	446
13.2.2	FREERADIUS.....	447
13.2.3	WINDOWS AS 802.1X PEER/SUPPLICANT – START WIREDAUTOCONFIG SERVICE .....	448
13.2.4	WINDOWS CONFIGURATION #1 - CISCO PEAP MODE .....	448
13.2.5	WINDOWS CONFIGURATION #2 - EAP-TLS MODE.....	450
13.2.6	KUBUNTU LINUX CONFIGURATION #1 – PEAP MODE.....	455
13.2.7	KUBUNTU LINUX CONFIGURATION #2 – EAP-TLS MODE .....	455
13.2.8	CISCO SWITCH AS AUTHENTICATOR .....	456
<b>14.0</b>	<b>APPENDIX H – LICENSES .....</b>	<b>457</b>
14.1	OPEN SOURCE LICENSE DECLARATION.....	457
<b>15.0</b>	<b>APPENDIX I – COUNTRY SPECIFIC INFORMATION.....</b>	<b>458</b>



# Copyright and Trademark

This manual and all software described herein is protected by Copyright: 2016 GE MDS LLC. All rights reserved. GE MDS LLC reserves its right to correct any errors and omissions in this publication.

## RF Regulatory Information

### RF Safety Notice (English and French)

RF Exposure



Concentrated energy from a directional antenna may pose a health hazard to humans. Do not allow people to come closer to the antenna than the distances listed in the table below when the transmitter is operating. More information on RF exposure can be found online at the following website:  
[www.fcc.gov/oet/info/documents/bulletins](http://www.fcc.gov/oet/info/documents/bulletins)

l'exposition aux RF



*Concentré d'énergie à partir d'une antenne directionnelle peut poser un risque pour la santé humaine. Ne pas permettre aux gens de se rapprocher de l'antenne que les distances indiquées dans le tableau ci-dessous lorsque l'émetteur est en marche. Plus d'informations sur l'exposition aux RF peut être trouvé en ligne à l'adresse suivante:  
[www.fcc.gov/oet/info/documents/bulletins](http://www.fcc.gov/oet/info/documents/bulletins)*

Antennas must not be co-located. All transmission antennas must be at least 20 cm apart to comply with FCC co-location rules.

### Orbit Device vs. Minimum RF Safety Distance

Radio Module Equipped	Minimum Safety Distance from Antenna
Cell	33 cm
NX915	23 cm
LN400	143 cm - using 5 dBi antenna 254 cm - using 10 dBi antenna 507 cm - using 16 dBi antenna
LN900	108 cm - using 5 dBi antenna 192 cm - using 10 dBi antenna 382 cm - using 16 dBi antenna
Other models	Consult factory prior to operation.

---

**NOTE** THE ORBIT MCR/ECR DOES NOT SUPPORT VOICE COMMUNICATIONS

---

### FCC Class A Notice

This device complies with Part 15 of the FCC Rules. Operation is subject to the following two conditions:

- This device may not cause harmful interference.
- This device must accept any interference received, including interference that may cause undesired operation.

**Note:** This equipment has been tested and found to comply with the limits for a Class A digital device, pursuant to Part 15 of the FCC Rules. These limits are designed to provide reasonable protection against harmful interference when the equipment is operated in a commercial environment. This equipment generates, uses, and can radiate radio frequency energy, and if it is not installed and used in accordance



with the instruction manual, it may cause harmful interference to radio communications. Operation of this equipment in a residential area is likely to cause harmful interference, in which case the user will be required to correct the interference at his own expense.

Modifications: Any modifications made to this device that are not approved by GE MDS LLC, Inc. may void the authority granted to the user by the FCC to operate this equipment.

### Industry Canada Notice

This Class A digital apparatus complies with Canadian ICES-003.

Cet appareil numérique de la classe A est conforme à la norme NMB-003 du Canada.

### Operational Safety Notices

The MDS Orbit MCR may not be used in an environment where radio frequency equipment is prohibited or restricted in its use. This typically includes aircrafts, airports, hospitals, and other sensitive electronic areas.

Do not operate RF devices in an environment that may be susceptible to radio interference resulting in danger, specifically:

- **Areas where prohibited by law** - Follow any special rules and regulations and obey all signs and notices. Do not use the Orbit MCR when you suspect that it may cause interference or danger.
- **Near Medical and life support equipment** - Do not use the Orbit MCR in any area where medical equipment, or life support equipment may be located, or near any equipment that may be susceptible to any form of radio interference.
- **All cables and conductors making connections to the units need to be rated at 85 °C or higher.**
- **Use Copper Conductors Only**
- **Use 18 AWG wire**

### FCC IDs of Installed Transmitters

As of the printing date, the following identifiers are assigned to the modules listed below. For the latest, official listings of all agency approvals, please contact your factory representative.

Config. Id – Radio Desc.	FCC ID	IC ID
E4V - 4G/3G CELL Modem	PKRNVWE362	3229B:E362
3G1 - 3G CELL Modem	RI7HE910	5131A-HE910
E4S,E42 - 4G/3G CELL Modem	n/a	n/a
4G1,4G2,4G3,4G4,4G5 - 4G/3G CELL Modem	N7NMC7355	2417C-MC7355
4GP - 4G/3G CELL Modem	N7NMC7354B	n/a
WIFI Module	M4Y-ZCN722MV1	3195A-ZCN722MV1
NX915 Module	E5MDS-NX915	101D-NX915
LN400 Module	E5MDS-LN400	101D-LN400
LN900 Module	E5MDS-LN900	101D-LN900

### Country-Specific Installation Data

Refer to APPENDIX I – Country Specific Information at the back of this manual for important notices regarding installation in specific countries.





## Servicing Precautions

No user-serviceable parts are contained inside this equipment. Opening of the unit by unauthorized personnel voids the warranty. All servicing must be performed by an authorized repair facility.

When servicing energized equipment, be sure to wear appropriate Personal Protective Equipment (PPE). During internal service, situations could arise where objects accidentally contact or short circuit components and the appropriate PPE would alleviate or decrease the severity of potential injury. When servicing equipment, all workplace regulations and other applicable standards for live electrical work should be followed to ensure personal safety.

## Manual Revision and Accuracy

This manual was updated to cover a specific version of firmware code. Accordingly, some screens and features may differ from the actual unit you are working with. While every reasonable effort has been made to ensure the accuracy of this publication, product improvements may also result in minor differences between the manual and the product shipped to you. If you have additional questions or need an exact specification for a product, please contact GE MDS using the information at the back of this guide. In addition, manual updates can be found on our web site at [www.gemds.com](http://www.gemds.com).

## Environmental Information

The manufacture of this equipment has required the extraction and use of natural resources. Improper disposal may contaminate the environment and present a health risk due to hazardous substances contained within. To avoid dissemination of these substances into our environment, and to limit the demand on natural resources, we encourage you to use the appropriate recycling systems for disposal. These systems will reuse or recycle most of the materials found in this equipment in a sound way. Please contact GE MDS or your supplier for more information on the proper disposal of this equipment.



**Battery Disposal**—This product may contain a battery. Batteries must be disposed of properly, and may not be disposed of as unsorted municipal waste in the European Union. See the product documentation for specific battery information. Batteries are marked with a symbol, which may include lettering to indicate cadmium (Cd), lead (Pb), or mercury (Hg). For proper recycling return the battery to your supplier or to a designated collection point. For more information see:

[www.weerohsinfo.com](http://www.weerohsinfo.com).

## Product Test Data Sheets

Test Data Sheets showing the original factory test results for this unit are available upon request from the GE MDS Quality Leader. Contact the factory using the information at the back of this manual. Serial numbers must be provided for each product where a Test Data Sheet is required.



## Safety Regulatory Information – (region-specific)

### CE Mark and RTTE Notice

This product, using the "WIFI internal radio module", "CELL modem", and "LN400 radio module" is CE marked and compliant with the RTTE directive. Other configurations will be added for EU use in future releases.

### CE General Safety - IEC/CSA/EN60950 (applicable for CE marked units)

**This product meets CE and General Safety requirements subject to the following constraints:**

- Power supply unit will be provided by the end users and installed indoor only. It shall be a certified SELV (Safety Extra Low Voltage) LPS (Limited Power Source) output rated 11-55Vdc, 100W max.
- This unit is to be installed in a restricted access location.
- Power (11-55Vdc)

### UL - CSA/us Notice (NOT applicable to CE marked units)

This product is approved for use in Class 1, Division 2, Groups A, B, C & D Hazardous Locations. Such locations are defined in Article 500 of the National Fire Protection Association (NFPA) publication NFPA 70, otherwise known as the National Electrical Code. The transceiver has been recognized for use in these hazardous locations by the Canadian Standards Association (CSA) which also issues the US mark of approval (CSA/US). The CSA Certification is in accordance with CSA STD C22.2 No. 213-M1987.

CSA Conditions of Approval: The transceiver is not acceptable as a stand-alone unit for use in the hazardous locations described above. It must either be mounted within another piece of equipment which is certified for hazardous locations, or installed within guidelines, or conditions of approval, as set forth by the approving agencies. These conditions of approval are as follows: The transceiver must be mounted within a separate enclosure which is suitable for the intended application. The antennas are not intended to be installed and mounted in a Class 1, Division 2 hazardous location. The antenna feedline, DC power cable and interface cable must be routed through conduit in accordance with the National Electrical Code. Installation, operation and maintenance of the transceiver should be in accordance with the transceiver's installation manual, and the National Electrical Code. **Tampering or replacement with non-factory components may adversely affect the safe use of the transceiver in hazardous locations, and may void the approval.** A power connector with screw-type retaining screws as supplied by GE MDS must be used.



Do not disconnect equipment unless power has been switched off or the area is known to be non-hazardous. Refer to Articles 500 through 502 of the National Electrical Code (NFPA 70) for further information on hazardous locations and approved Division 2 wiring methods.






## MCR ATEX Directive Compliance Information (as applicable)



When the ATEX mark is present on the label, the Orbit MCR is ATEX Compliant with the “Zone 2, Cat 3” requirements pending the proper installation requirements listed below.

All RF modules contained within an ATEX compliant Orbit MCR have a conducted RF power maximum limit of 2W.

The MCR products were evaluated based on the following ratings as per SIRA 14ATEX4119X:

-  II 3 G
- Ex nA IIC T4 Gc
- Amb -30°C to +70°C
- T4 (max surface temp 70°C)

Decoded:

- **II** - Equipment Group - Electrical equipment intended for use in places with an explosive gas atmosphere other than mines susceptible to firedamp
- **3 G** - Zone 2 - Normal Protection level Gas - Provides a low level of protection and is intended for use in a Zone 2 hazardous area
- **Ex nA** - Gas & Air Mixture Zone 2 protection - Non-Sparking
- **IIC** - Gas Group IIC - Hydrogen/Acetylene
- **T4** - temperature classification (max surface temp 70°C)
- **Gc** - Gas atmospheres - assured level of protection against becoming an ignition source in normal operation

ETSI/CE Standards: (subject to revision)

- EN 55022: 2010
- EN 55024: 2010
- EN 60950-1 2006 +A1:2010; +A11:2009; +A12:2011
- EN 62311: 2008
- EN 300 328: V1.7.1
- EN 300 440-2: V1.4.1
- EN 301 489-1: V1.9.2
- EN 301 489-3: V1.4.1
- EN 301 489-7: V1.3.1
- EN 301 489-17: V2.2.1
- EN 301 489-24: V1.5.1
- EN 301 511: V9.0.2
- EN 301 908-1: V5.2.1
- EN 301 908-2: V5.2.1

ATEX Special Conditions for Safe Use as per SIRA 14ATEX4119X:



- Tighten wire clamps to 5 in-lb (0.6 Nm)
- The 60Vdc rated supply shall be protected such that transients are limited to a maximum of 84Vdc; no such protection is required for the signal lines.
- The device shall be installed in an enclosure that maintains an ingress protection rating of at least IP54 and meets the enclosure requirements of EN 60079-0 and EN 60079-15. The installer shall ensure that the maximum ambient temperature of the module when installed is not exceeded.
- The USB connection shall only be used in an unclassified (non-hazardous) area.
- The SIM card shall be connected / disconnected only in a non-hazardous area or when the device is not energized.



## Product Country Certification Information – (Non-NA/EU)

### MCR-3G Selected Country Certification Information

#### Australia



#### Brazil



Homologation Number and UCC/EAN-128 Code = (01) 0789 8934163051 vary based on the model and model options chosen.

Este equipamento opera em caráter secundário, isto é, não tem direito a proteção contra interferência prejudicial, mesmo de estações do mesmo tipo, e não pode causar interferência a sistemas operando em caráter primário.

Este produto está homologado pela Anatel, de acordo com os procedimentos regulamentados pela Resolução nº 242/2000 e atende aos requisitos técnicos aplicados, incluindo os limites de exposição da Taxa de Absorção Específica referente a campos elétricos, magnéticos e eletromagnéticos de radiofrequência, de acordo com as Resoluções nº 303/2002 e 533/2009.

Este dispositivo está em conformidade com as diretrizes de exposição à radiofrequência quando posicionado a pelo menos 20 centímetro de distância do corpo. Para maiores informações, consulte o site da ANATEL – [www.anatel.gov.br](http://www.anatel.gov.br)

#### Japan



003-140073



D140039003

#### Mexico



- IFT number [IFT] = RTIGEGE14-0827-A1



- IFT number [IFT] = RCPGEGE14-1031

La operación de este equipo está sujeta a las siguientes dos condiciones:

1. es posible que este equipo o dispositivo no cause interferencia perjudicial y
2. este equipo o dispositivo debe aceptar cualquier interferencia, incluyendo la que pueda causar su operación no deseada.

### **New Zealand**



### **Philippines**

Conformity Number: ESD-GEC-1402584



### **South Africa**



### **UAE**

- Registered number = ER0133084/14
- Dealer number = DA0132013/14

## **ECR Selected Country Certification Information**

TBD





# 1.0 Product Overview and Applications

## 1.1 Introduction

This manual describes the MDS™ Orbit Multiservice Connect Router (MCR) (Figure 1-1), and the MDS™ Orbit Edge Connected Router (ECR) (Figure 1-2) . The unit is a highly secure, industrial grade, wireless communication product for broad-based applications, including control center monitoring, well site pad operations and video surveillance. It serves the need for localized WiFi communications with a cellular back-up or backhaul option, while providing the extended temperature range and industrial-grade packaging inherent to GE MDS products. These features allow the best use of communication options at each installation site.



**Figure 1-1. MCR-4G Unit  
(Standard 2E1S configuration shown)**



**Figure 1-2. ECR-900 Unit**

With a common hardware architecture and user interface, the MCR and ECR offers flexibility in network design and application, with simplified training, maintenance and deployment costs. GE MDS provides an array of communication products with multiple interface options and a variety of enclosures to give customers the choice and flexibility to design their communications network to meet geographic and industry specific challenges. Information on other GE MDS products can be found by visiting our website at [www.gemds.com](http://www.gemds.com).

GE MDS has produced a series of instructional videos for configuration and setup of the Orbit MCR products on YouTube™. These are available free of charge at: <http://tinyurl.com/pey2ull>



### 1.1.1 Product Variations

The MDS™ Orbit MCR is factory configured with various Network Interface Cards (NICs), based on order selection.





The label on the bottom of the unit identifies the radio model as GE MDS MCR. It includes the device serial number and agency/regulatory identifications, including IDs for applicable embedded modules. See “Agency/Regulatory Approvals” on Page 385 for more information.

Orbit MCR devices with specific network interfaces may be referred to with the common names below:

- MCR-4G — Name for the product when configured with 4G/LTE (Verizon ONLY).
- MCR-4GS — Name for the product when configured with 4G/LTE (EMEA/APAC)
- MCR-4GN — Name for the product when configured with 4G/LTE (North America).
- MCR-3G — Name for the product when configured with 3G.
- MCR-900 — Name for the product when configured with unlicensed 900 MHz (FHSS and DTS).
- MCR-LN — Name for the product when configured with licensed narrowband QAM radios.

The MDS™ Orbit ECR is factory configured with various Network Interface Cards (NICs), based on order selection.

The label on the bottom of the unit identifies the radio model as GE MDS ECR. It includes the device serial number and agency/regulatory identifications, including IDs for applicable embedded modules. See “Agency/Regulatory Approvals” on Page 385 for more information.

Orbit ECR devices with specific network interfaces may be referred to with the common names below:

- ECR-4G — Name for the product when configured with 4G/LTE (North America).
- ECR-4GS — Name for the product when configured with 4G/LTE (EMEA/APAC)
- ECR-3G — Name for the product when configured with 3G.
- ECR-900 — Name for the product when configured with unlicensed 900 MHz (FHSS and DTS).
- ECR-LN — Name for the product when configured with licensed narrowband QAM radios.

### 1.1.2 About This Manual

This manual is intended for systems engineers, network administrators and others responsible for planning, commissioning, using and troubleshooting the wireless system. Installation steps are *not* included in this publication. For installation instructions, refer to the companion *Orbit MCR Setup Guide*, part no. 05-6709A01 or *Orbit ECR Setup Guide*, part no. 05-6709A02. Electronic copies of all user documentation are available free of charge at [www.gemds.com](http://www.gemds.com)



#### INSTALLATION & SETUP GUIDES

*The Orbit MCR Setup Guide, part no. 05-6709A01 and Orbit ECR Setup Guide, part no. 05-6709A02 contain installation instructions, as well as basic startup information for these products.*

*All GE MDS user manuals and updates are available online at [www.gemds.com](http://www.gemds.com)*

### Software Command Notations

The product is designed for software control via a connected PC. As such, there are no external controls or adjustments present. To show the names of software commands, keyboard entries, or other information displayed on a PC screen, a bolded font is used throughout the manual. In the case of tabular data displayed on a PC screen, a variation on this font is used to maintain proper layout. See examples that follow.

**Bolded font example (used in text for software commands and keyboard entries)**



**Bolded font example (used to show tables displayed on a PC screen)**

In the Device Management section of this manual (Page 36), there are a number of command strings where information is presented by the unit and a reply is required from the user. In such cases, information from the unit is shown in a non-bolded font and the user response is shown in bold. For example:

**(none) login: admin**

Further, in some cases, command lines will be shown with non-bolded, *italicized* text contained within the string. Such text indicates the need for user-supplied variable parameters, such as the name of an item. For example:

**% set interfaces interface myBridge type bridge**

In the above example, you would enter the specific name of your bridge to complete the entry.

---

**NOTE** The LAN port should be assigned IP addresses only if it is a routed interface (that is, not in a bridge).

---

---

**NOTE** The software commands and responses shown in this manual were obtained from a unit operating in a lab environment. The information displayed may differ from field service conditions.

---



## 2.0 Product Description

The Orbit MCR and ECR are rugged networking routers providing comprehensive solutions for IP/Ethernet, serial and machine-to-machine wireless communication.

### 2.1 Key Features

MCR units include the following key features:

- **Security**—The unit uses industry-leading security features to protect data while maintaining compatibility with deployed infrastructures. Features include AAA user access with passwords and lockout protection, VPN (IPSec), signed firmware, secure booting, integrity management and more.

---

**NOTE** The Orbit MCR device is designed for high security environments. As such, management of the device does not support Telnet, but instead implements the more secure SSH protocol.

---

- **Small Form Factor**—The unit is housed in a rugged enclosure suited for operation in harsh industrial environments. It requires only protection from direct exposure to the weather and may be easily mounted inside a NEMA enclosure for outdoor applications when required.
- **Network Interfaces**—Several network interfaces are present to provide connectivity for a variety of equipment and applications. Ethernet, serial and WiFi interfaces provide local connections while a cellular interface provides access to public carrier networks.
- **User Interface**—Multiple user interfaces are provided for configuration and monitoring of the unit. These include local serial console, web, SSH and USB.

---

**NOTE** For units certified and installed in hazardous locations, use only the serial or Ethernet connections on the unit's front panel. Do *not* use the USB port in hazardous locations.

---

- **Network Management System**— Orbit MCR is supported by GE MDS PulseNET, a Network Management System (NMS), providing monitoring of small and large scale deployment of all GE MDS devices.
- **Tamper Detection**—The unit contains a 3-axis magnetometer that can be used to detect changes to the unit's physical environment after installation and generate notification of the change if it exceeds configurable thresholds. See "Tamper Detection" on Page 179.

### 2.2 Interface Types

- ECR units are provide external interfaces 1 Ethernet, 1 Serial and 1 USB.
- MCR units are offered in three external interface offerings; 2 Ethernet/1 Serial (2E1S), 2 Serial/1 Ethernet (2S1E), and 4 Ethernet/2 Serial (4E2S).
- The ECR and the MCR with 4E2S each only support one Network Interface Card. The MCR 2E1S and 2S1E support two. Most information applies equally to both configurations.

### 2.3 Network Interface Cards (NICs)

#### 2.3.1 4G LTE/CDMA (Verizon Only)

The 4G LTE module is capable of operation on the Verizon Wireless LTE/CDMA network (LTE 700 MHz Band 13) in the United States. The unit supports routing of TCP/UDP/IP data from the Cellular WAN network interface to any of the other network interfaces using the IPsec VPN or network address and port translation (NAPT) feature and to a serial port using the terminal server service. The configuration of these use cases is specified in respective sections on VPN, Firewall and NAT and Terminal Service.

Orbit MCR with this modem is certified for operation on Verizon Wireless LTE/CDMA (1xRTT/EVDO) network (ODI certified) in the United States. In addition it is also certified for use with Verizon Wireless



Private Network service (PN Compliant). For more information, refer to “ APPENDIX E – Obtaining Provisioned 4G/LTE Service (Verizon)” on Page 417.

The cellular modem inside the unit supports main (primary) and secondary antenna (for receive diversity). The primary antenna must be installed for cell modem to register with the cellular network. It is strongly recommended that a secondary antenna be installed for achieving a robust cellular link.

This 4G modem supports following technologies:

- LTE 1900(B2), AWS (B4), 850(B5), 700 (B13), 700(B17), 1900(B25)
- CDMA 1xRTT/EV-DO Rev A - 800(BC0), 1900(BC1), 800(BC10)

Orbit MCR with this modem is Verizon ODI certified for operation on 4G LTE/3G CDMA networks, in North America - with Verizon Wireless. Orbit MCR is also compliant with Verizon Private Network

### **2.3.2 4G LTE, HSPA+, GSM/GPRS (EMEA/APAC)**

This 4G modem supports following technologies:

- LTE 2100(B1), 1800(B3), 2600(B7), 900(B8), 800(B20) MHz
- GSM/GPRS/EDGE 850/900/1800/1900 MHz
- UMTS/HSPA/HSPA+ 2100(B1), 1900(B2), 850(B5), 900(B8) MHz

Orbit MCR with this modem is GCF certified for operation on 4GLTE/3G GSM/UMTS networks, primarily in EMEA and APAC countries.

### **2.3.3 4G LTE, HSPA+, GSM/GPRS (North America)**

This 4G modem supports following technologies:

- LTE 1900(B2), AWS (B4), 850(B5), 700 (B13), 700(B17), 1900(B25)
- GSM/GPRS/EDGE 850/900/1800/1900 MHz
- UMTS/HSPA/HSPA+ 2100(B1), 1900(B2), AWS (B4), 850(B5), 900(B8) MHz

Orbit MCR with this modem is PTCRB certified for operation on 4GLTE/3G GSM/UMTS networks, primarily in North America - US and Canada.

This modem is also certified for operation on Verizon and Sprint networks in North America.

### **2.3.4 3G Cell**

The 3G modem supports following technologies:

- GSM/GPRS/EDGE 850/900/1800/1900 MHz
- UMTS/HSPA/HSPA+ 800/850, 900, AWS1700, 1900, 2100 MHz

Orbit MCR with this modem is PTCRB and GCF certified for operation on 2G/3G GSM/UMTS networks around the world. This modem is also certified for operation on AT&T networks in North America.

### **2.3.5 900 MHz Unlicensed**

900 MHz unlicensed operation is provided by the NX915 module. The NX915 provides long-distance communications with data rates ranging from 125 kbps to 1.25 Mbps, suitable to interface both Ethernet and Serial controllers such as PLCs, RTUs and SCADA systems. The NX915 NIC utilizes a combination of FHSS (Frequency Hopping Spread Spectrum), DTS (Digital Transmission System) and hybrid FHSS/DTS technologies to provide dependable wireless communications.

#### **Key Benefits**

- Multiple data rates to meet application range and link budget: 125 kbps, 250 kbps, 500 kbps, 1000 kbps, 1250 kbps
- Up to 60 miles LOS (Line of Sight)



- Single unit AP, Remote, or Store and Forward
- Patent pending extremely low latency and robust proprietary Media Access Control specifically designed for 900 MHz communications
- High Reliability
  - Error detection and re-transmit on error for Unicast traffic
  - Repeat support for Multicast/Broadcast traffic
  - Interference avoidance will not carelessly send data if a particular frequency cannot support communications because of interference. Communications deferred until frequency becomes available or network moves to a new frequency
- Ability to skip frequency zones, useful for persistent interferers or co-located networks
- Fragmentation support to minimize on-air time in noisy environments
- Ad-hoc network discovery with multiple synchronization methods
- Fast mode for minimizing synchronization times
- Auto mode for discovering network modulation and optimal paths based on statistical analysis of the network
- Store and Forward
  - Supports up to 8-hops SAF level depth.
  - Supports multiple SAFs on any level.
  - Automatically adjusts Media Access scheme for SAF network to support simultaneous communications at alternating levels and minimize latency, using dynamic fragmentation.
  - Supports dynamic and static paths providing flexibility in designing the wireless network.
- Quality of Service (QoS)
  - Priority Queues
  - Source/Destination port and addresses
  - Protocol (UDP, TCP, etc.)

### 2.3.6 Licensed Narrowband

Licensed Narrowband operation is provided by the LN series NIC modules. Licensed Narrowband modules provide robust long-distance communication in channel bandwidth sizes of 6.25KHz, 12.5KHz, and 25KHz using QAM technology. Depending on bandwidth, raw data rates range from 20kbps to 120kbps. LN modules provide long-distance communications suitable to interface both Ethernet and Serial controllers such as PLCs, RTUs and SCADA systems.

#### Key Benefits

- Bi-Directional Adaptive QAM Modulation (QPSK, 16QAM, 64QSM)
- Up to 50 miles LOS (Line of Sight)
- Single unit AP or Remote
- Low latency and robust proprietary Media Access Control specifically designed narrowband communications
- High Reliability
  - Error detection and re-transmit on error for Unicast traffic
  - Multiple Forward Error Correction (FEC) modes including adaptive FEC



- Quality of Service (QoS)
  - Priority Queues
  - Source/Destination port and addresses
  - Protocol (UDP, TCP, etc.)

## 2.4 Typical Applications

The unit provides flexibility in network communications and may be used in a wide variety of applications. In one common scenario, it provides cellular connectivity to locally-connected devices that are located on a local/internal/private LAN or WiFi network. The unit acts as an Access Point on the WiFi interface to provide connectivity to WiFi clients. Figure 2-1 shows an example network in which the unit provides connectivity to multiple end devices. The end devices are connected via Ethernet, serial and WiFi links.

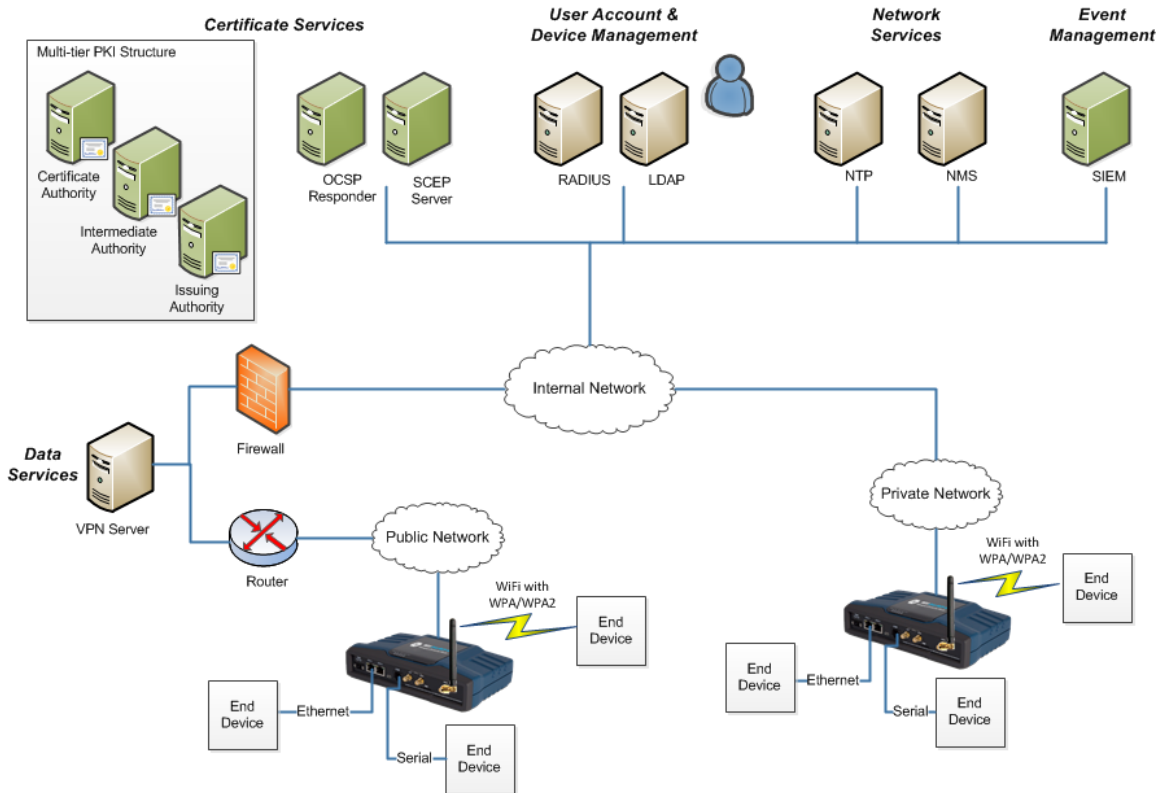


Figure 2-1. Typical MCR Application

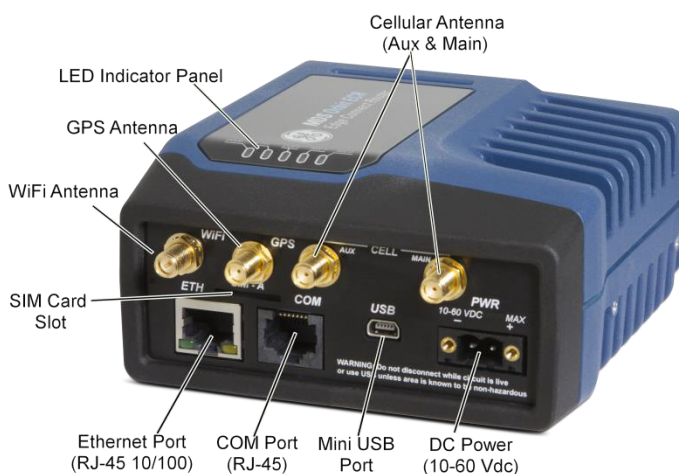
## 2.5 MCR and ECR Connectors and Indicators

Figure 2-2 shows the unit's front panel connectors and indicators. These items are referenced in the text that follows. The unit's LED Indicator Panel is described in Table 2-5.



**Figure 2-2. MCR Connectors and Indicators  
(Sample configuration with Cell, WiFi, two Ethernet and one Serial port)**

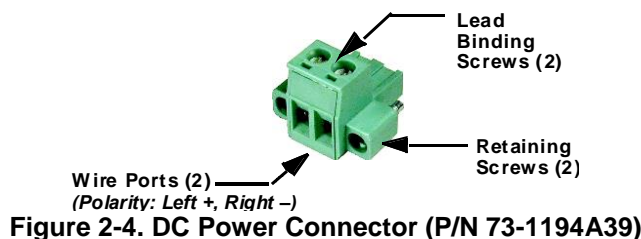
Figure 2-3 shows the unit's front panel connectors and indicators. These items are referenced in the text that follows. The unit's LED Indicator Panel is described in Table 2-5.



**Figure 2-3. ECR Connectors and Indicators  
(Sample configuration with Cell, WiFi, Ethernet and Serial port)**

**PWR**—Two-conductor DC input connection .

- The DC power connector (Figure 2-4) is keyed and can only be inserted one way.
- Use Copper Conductors Only
- Use 18 AWG wire
- Tighten wire clamps to 5 lb-in. (0.6 Nm)



**Figure 2-4. DC Power Connector (P/N 73-1194A39)**

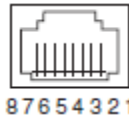


**NOTE** The unit is designed for use in negative ground DC power systems only. Only use the power supply provided by the manufacturer for the product or a certified LPS power supply rated for nominal power 11-55 VDC, 4.5 A maximum must be used. Otherwise, safety of the product may be impaired. In case of doubt, please consult the local authorized suppliers.

Input voltage to the unit must be well filtered and within the nominal range of 11-55 VDC . The maximum rated power consumption of the device is 15 watts, but actual power may be much less, depending on configuration. The power supply must be capable of supplying the expected maximum power for the installation. For expected power requirements in common configurations, see “Technical Specifications” on Page 383.

**ETH1 / ETH2**— Ethernet connection port. These ports support both device management and payload data transport. Depending on ordered options, the unit may have one or two Ethernet ports. This is a standard RJ-45 jack and features MDIX auto-sensing capability, allowing straight-through or crossover cables to be used.

Connecting to the unit via SSH supports device management and provides the same user interface available using the unit’s COM1 serial port. Various options are available for passing Ethernet data, allowing system administrators to optimize the configuration for maximum efficiency, based on the system’s operating characteristics.



(As viewed from the outside the unit)

**Table 2-1. ETH1/2 Pin Details**

Pin	Function	Pin	Function
1	Transmit Data (TX) High	5	Unused
2	Transmit Data (TX) Low	6	Receive Data (RX) Low
3	Receive Data (RX) High	7	Unused
4	Unused	8	Unused

**USB Port**—This port allows for connection of a laptop or PC. The port provides a local console for management of the device. A standard host-to-mini device USB 2.0 cable may be used.

**COM1/COM2 Port**—This connector serves as the serial interface port for both console management and payload data. Depending on ordered options, the unit may have one or two COM ports. By default, the port is enabled for local console control. The COM port serves as the primary interface for connecting the unit to an external DTE serial device supporting RS-232 or RS-485. If necessary, an adapter may be used to convert the unit’s RJ-45 serial jack to a DB-9F type (GE MDS 73-2434A12).

**NOTE** Not all PCs include a serial port. If one is not available, the unit’s USB port may be used to access the device management interface. Alternatively, a PC’s USB port may be used with a USB-to-Serial adapter and appropriate driver software. These devices are available from several manufacturers. A video covering USB driver installation may be accessed from the following link: <http://tinyurl.com/pey2ull>

The COM port supports a serial data rate of 1200-230400 bps (115200 default, asynchronous only). The unit is hardwired as a DCE device. Supported data formats for the COM port are:

**8N1** - 8 char bits, no parity, 1 stop bit (*Default setting*)

**8N2** - 8 char bits, no parity, 2 stop bits





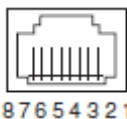
- 8O1** - 8 char bits, odd parity, 1 stop bit
- 8O2** - 8 char bits, odd parity, 2 stop bits
- 8E1** - 8 char bits, even parity, 1 stop bit
- 8E2** - 8 char bits, even parity, 2 stop bits
- 7N1** - 7 char bits, no parity, 1 stop bit
- 7N2** - 7 char bits, no parity, 2 stop bits
- 7O1** - 7 char bits, odd parity, 1 stop bit
- 7O2** - 7 char bits, odd parity, 2 stop bits
- 7E1** - 7 char bits, even parity, 1 stop bit
- 7E2** - 7 char bits, even parity, 2 stop bits.

The tables on the following page provide pin descriptions for the COM1 data port in RS-232 mode and RS-485 modes, respectively.

---

**NOTE** The COM2 port, if present, is restricted to RS-232 mode; it cannot be used for RS-485.

---



(As viewed from the outside the unit)

**Table 2-2. COM1/2 Port Pin Details (RS-232)**

Pin Number	Input / Output	Pin Description
1	Reserved	COM1 only: ALARM Output (refer to "Alarms" on Page 150 )
2	OUT	DCD (Data Carrier Detect)
3	Reserved	--
4	Ground	Connects to ground (negative supply potential) on chassis
5	OUT	RXD (Received Data)—Supplies received data to the connected device
6	IN	TXD (Transmitted Data)—Accepts TX data from the connected device
7	OUT	CTS (Clear to Send)
8	IN	RTS (Request to Send)



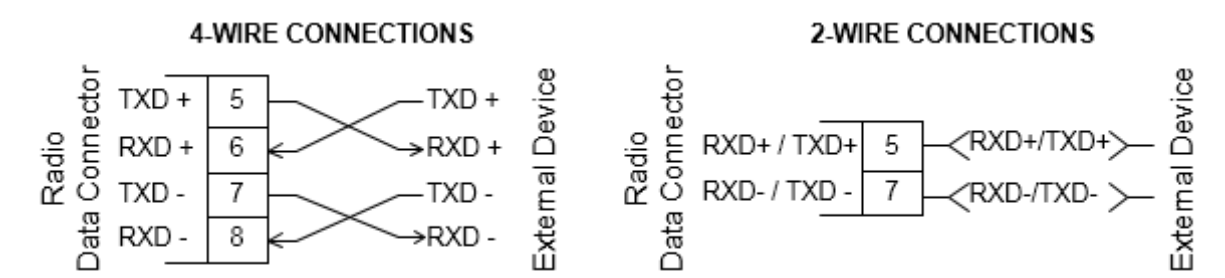
**Table 2-3. COM1 Port Pin Details (RS-485)**

Pin Number	Input/Output	Pin Description
1	Reserved	ALARM Output (refer to “Alarms” on Page 150)
2	OUT	DCD (Data Carrier Detect)
3	Reserved	--
4	Ground	Connects to ground (negative supply potential) on chassis
5	OUT	TXD+/TXB (Transmitted Data +)—Non-inverting driver output. Supplies received payload data to the connected device.
6	IN	RXD+/RXB (Received Data +) — Non-inverting receiver input. Accepts payload data from the connected device.
7	OUT	TXD-/TXA (Transmitted Data -)—Inverting driver output. Supplies received payload data to the connected device.
8	IN	RXD-/RXA (Received Data -) — Inverting receiver input. Accepts payload data from the connected device.

COM1 Port notes and wiring arrangements (for RS-485)

- The COM1 port supports 4-wire and 2-wire RS-485 mode as follows:
  - RXD+ / RXB and RXD- / RXA are data sent *into* the unit
  - RXD+ / RXB is positive with respect to RXD- / RXA when the line input is a “0”
  - TXD+ / TXB and TXD- / TXA are data sent *out* by the unit
  - TXD+ / TXB is positive with respect to the TXD- / TXA when the line output is a “0”
- 2-wire RS-485 mode connections:
  - Connect pins 5&6 (TXD+/RXD+) together and connect to (TXD+/RXD+) tied together on connected device
  - Connect pins 7&8 (RXD-/TXD-) together and connect to (TXD-/RXD-) tied together on connected device
- 4-wire RS-485 mode connections:
  - Connect pin 5 (TXD+) to RXD+ of connected device
  - Connect pin 6 (RXD+) to TXD+ of connected device
  - Connect pin 7 (TXD-) to RXD- of connected device
  - Connect pin 8 (RXD-) to TXD- of connected device

Figure 2-5 illustrates the 2-wire and 4-wire connections described above.



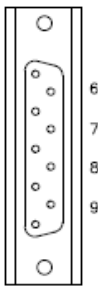
**Figure 2-5. EIA-485 4-Wire/2-Wire Connections**



**NOTE** GE MDS part number 73-2434A25 provides a custom RJ45 to DB9 Adapter for use with the Orbit MCR and other GE MDS products. The chart below provides details for connections made using this adapter.

**WIRING CHART**

RJ-45 PIN	FUNCTION	DB9 PIN	DB9 CONNECTOR
1	DSR	6	
2	DCD	1	
3	DTR	4	
4	GND	5	
5	RXD	2	
6	TXD	3	
7	CTS	8	
8	RTS	7	



**LED Status Indicators**—The LEDs on the unit provide visual indications of the status of the device as shown in the following chart:



**Figure 2-6. LED Status Indicators**

Table 2-4. Description of LED Status Indicators

LED Name	LED State	Description
PWR (DC Power)	Off	No power to unit
	Solid Green	Unit is powered, no problems detected
	Fast Blink/Red (1x/sec.)	Alarm indication
ETH (Ethernet)	Off	No Ethernet link to network
	Solid Green	Ethernet link present
	Blinking Green	Ethernet traffic in/out
COM (Serial Comm. Port)	Off	No serial connection, or idle
	Blinking Green	Serial traffic in/out
NIC1	Off	Interface disabled
	Solid Green	Interface enabled
NIC2	Off	Interface disabled
	Solid Green	Interface enabled

**NOTE** In addition to the LEDs above, the Ethernet connector has two embedded LEDs. A yellow indicates a link at 100 Mbps operation. A flashing green indicates Ethernet data traffic.



Depending on the interfaces ordered, the NIC1 and NIC2 slot can be populated with a Cellular modem, a WiFi interface, LnRadio interface, or an NxRadio interface. Described in Table 2-5 and Table 2-6 below, are the possible NIC1 and NIC2 LED combinations based on the product configuration ordered.

**Table 2-5. MCR NIC LED Descriptions**

Product Configuration	NIC1	NIC2
MCR-4G + WiFi	Cellular	WiFi
MCR-4G Only	Cellular	Off
MCR-3G + WiFi	Cellular	WiFi
MCR-3G Only	Cellular	Off
MCR-WiFi only	Off	WiFi
MCR-900 + 4G	Cellular	900 ISM (NxRadio)
MCR-900 + WiFi	WiFi	900 ISM (NxRadio)
MCR-900 + 3G	Cellular	900 ISM (NxRadio)
MCR-900 Only	Off	900 ISM (NxRadio)
MCR-LN + 3G	Cellular	Lic. Narrowband (LnRadio)
MCR-LN + WiFi	WiFi	Lic. Narrowband (LnRadio)
MCR-LN + 3G	Cellular	Lic. Narrowband (LnRadio)
MCR-LN Only	Off	Lic. Narrowband (LnRadio)

**Table 2-6. ECR NIC LED Descriptions**

Product Configuration	NIC1	NIC2
ECR-4G + WiFi	Cellular	WiFi
ECR-4G Only	Cellular	Off
ECR-3G + WiFi	Cellular	WiFi
ECR-3G Only	Cellular	Off
ECR-WiFi only	Off	WiFi
ECR-900 + WiFi	WiFi	900 ISM (NxRadio)
ECR-900 Only	Off	900 ISM (NxRadio)
ECR-LN + WiFi	WiFi	Lic. Narrowband (LnRadio)
ECR-LN Only	Off	Lic. Narrowband (LnRadio)

## 2.6 Grounding Considerations

To minimize the chance of damage to the unit and its connected equipment, a safety ground (NEC Class 2 compliant) is recommended, which bonds the chassis, antenna system(s), power supply and connected data equipment to a *single-point* ground, keeping all ground leads as short as possible.

Normally, the unit is adequately grounded if mounted with the flat brackets to a well-grounded metal surface. If the unit is not mounted to a grounded surface, it is recommended that a safety ground wire be



attached to the screw provided on the bottom corner of the enclosure, in the recessed flat area. Alternatively, a safety ground wire may be attached to one of the mounting bracket screws.

The use of a lightning protector is recommended where the antenna cable enters the building; Bond the protector to the tower ground, if possible. All grounds and cabling must comply with applicable codes and regulations. One source for lightning protection products may be found online at <http://www.protectiongroup.com/PolyPhaser>.

## 2.7 Mounting Options

The unit may be mounted with flat mounting brackets *or* an optional 35 mm DIN rail attachment. Figure 2-7 shows the mounting dimensions for a unit equipped with flat mounting brackets.

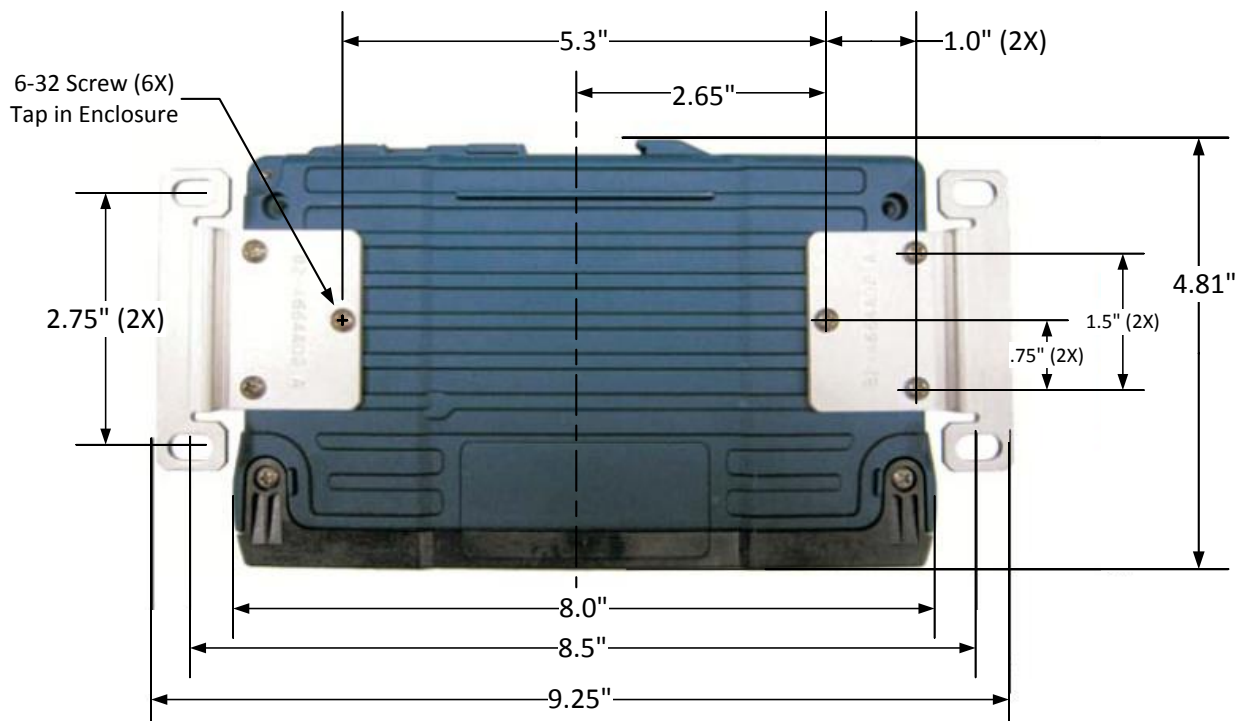


Figure 2-7. MCR Flat Mounting Bracket Dimensions

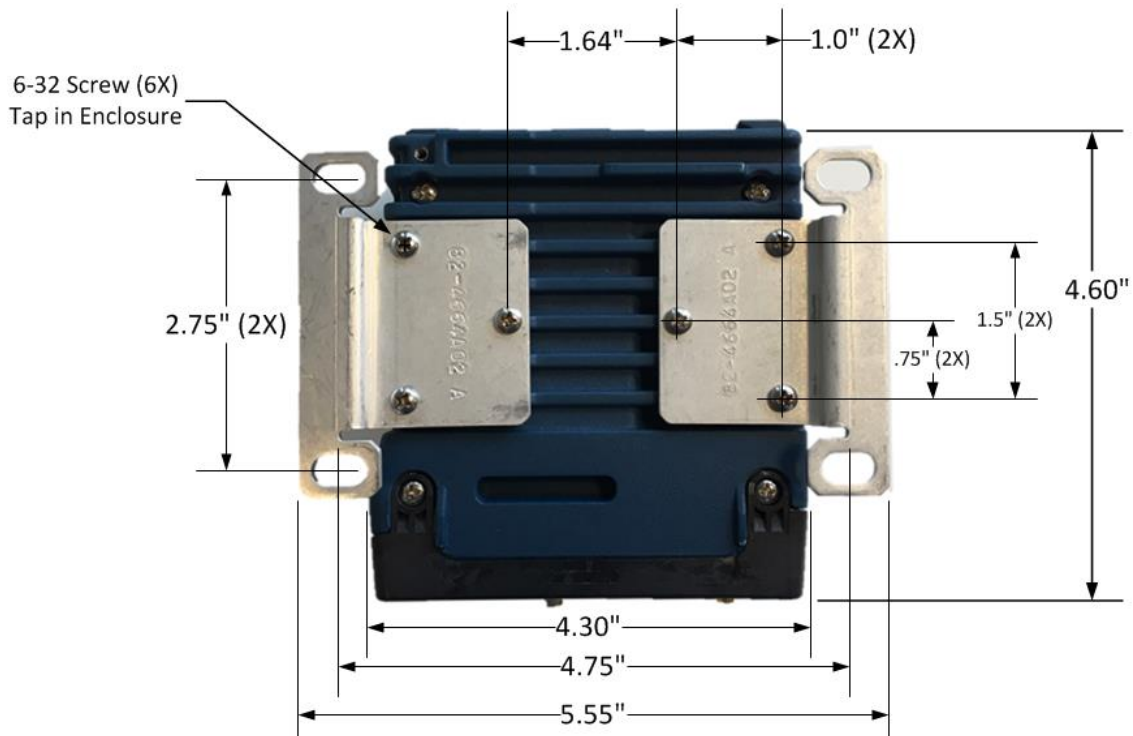


Figure 2-8. ECR Flat Mounting Bracket Dimensions

---

**NOTE** To prevent moisture from entering the unit, do not mount the case with the cable connectors pointing up. Also, dress all cables to prevent moisture from running along the cables and into the unit.

---

### 2.7.1 Optional DIN Rail Mounting

If ordered with the DIN rail mounting option, the unit is supplied with a DIN rail clip attached to the case. The integrated bracket on the unit's case allows for quick installation and removal from a DIN mounting rail as shown in Figure 2-9.



Figure 2-9. DIN Rail Attachment and Removal  
(Pull down tab to release from rail)



## 2.8 Antenna Planning and Installation

Consideration must be taken to select appropriate antennas for optimal RF performance. This section reviews the key factors involved in selecting and installing antennas for the Orbit MCR and ECR. Only approved antennas may be used on the unit's RF output connectors. These antennas are listed in each applicable section for each RF type. The use of non-approved antennas may result in a violation of FCC rules and subject the user to FCC enforcement action.

**Cell Antennas** (Aux and Main)—These SMA coaxial connectors are for attachment of cellular antennas. The MAIN connection is for basic cellular transmission/reception and the AUX connector is for attachment of a receive-only antenna which provides MIMO receive operation (diversity) with standard Cell modules, improving signal quality in many installations. In general, both antennas should always be used for cellular operation. The GE MDS part number for this antenna type is 97-2485A04.



**Figure 2-10. Directly-Connected Cellular Antenna (Typical Style)**  
(GE MDS Part No. 97-2485A04)

**WiFi Antenna**—Antenna connection for 2.4 GHz WiFi service. The connector appears similar to the cellular connectors discussed above, but is a *Reverse-SMA* type. It contains a pin that matches with an SMA-F connector. The GE MDS part number for this antenna is 97-4278A34.

To connect an external WiFi antenna, 97-4278A48, a Reverse SMA to N-Female cable and antenna mount is required. These are not sold from GE MDS but are available from many retailers.

**900 MHz ISM Antennas** —Antenna connection is a TNC connector. Multiple options are available for this unlicensed operation.

---

**NOTE** For 900MHz ISM operation (NX915 NIC) professional installation is required.

---

---

**NOTE** For Australia and New Zealand the maximum EIRP must be limited to 30 dBm. If  $((\text{antenna gain} - \text{feed line loss}) + \text{power output setting}) > 30$ , then the power output of the NX915 must be reduced.

---

---

**NOTE** For regions governed by FCC/IC compliance the maximum EIRP must be limited to 36 dBm. If  $((\text{antenna gain} - \text{feed line loss}) + \text{power output setting}) > 36$ , then the power output of the NX915 must be reduced.

---

**Licensed Narrowband Antennas** —Antenna connection is a TNC connector. Multiple options are available based on radio type and site-specific licensing rules.



## Antenna Type and Orientation (Cell & Wi-Fi)

It is important to use antennas designed to operate in the applicable cellular coverage bands with a Return Loss of 10 dB or better. Placement of the antennas also plays a key role in the coverage of the system. While the antennas can be placed directly on the face of the unit in some short range installations, the best performance is obtained when mounting antennas remotely using low loss coaxial cable. Antennas mounted in close proximity to each other can couple signals between them and desensitize the RF module.

When placing the indoor SMA style “paddle” antennas on the face of the unit, position them with a 90 degree angle of separation to improve the isolation. A “V” or an “L” configuration is a common approach to use with the Main channel typically mounted for vertical polarization. The multipath nature of Cellular systems means that polarization for indoor use is not normally a critical factor. Isolation between the antennas is more important.

Note that with any installation, there needs to be a minimum 20 cm spacing between all transmit antennas to avoid co-location difficulties.

### Indoor use case:

This scenario employs direct mounting of an LTE paddle antenna (GE MDS PN: 97-2485A04) on the Main and Aux Cell channels and cabled mounting of the Wi-Fi antenna (GE MDS PN: 97-4278A34) using a magnetic mount (GE MDS PN: 97-4278A78). This configuration offers easy mobility for evaluation purposes or indoor applications with good cellular signal coverage (see Figure 2-11).



**Figure 2-11. Direct Mounting of Cell Antenna; Cabled WiFi Antenna  
Minimum 8-inch (20.32 cm) separation between cell and WiFi antennas**

This arrangement employs cabled mounting of the LTE paddle antennas (GE MDS 97-2485A04) on the Main and AUX Cell channels and cabled mounting of the Wi-Fi antenna (GE MDS 97-4278A34) using a magnetic mount (GE MDS 97-4278A78). The Wi-Fi antenna may also be directly attached to the unit, if desired. This configuration works well for indoor installations in equipment closets, or for more permanent applications.

### Outdoor use case:

External enclosures—If the system is going to be installed in a weathertight enclosure and mounted outside in the elements, cabled use of external LTE antennas (GE MDS PN: 97-2485A05) on the Main and AUX Cell ports, with cabled use of the External Wi-Fi antenna (GE MDS PN: 97-4278A48) is a good solution. This configuration requires a suitable metallic ground plane for the Cellular antennas (8" diameter disc minimum for the 97-2485A05 series) or a suitable counterpoise for frequencies as low as 698 MHz. Metal enclosures work well for ground plane requirements, when ground contact inside the box is not impeded by painted surfaces.

Do *not* use internally mounted antennas inside of metal enclosures.

Other antenna configurations can be easily customized for applications not listed here. Consult your factory representative for installation matters.





## Antenna Installation Guidance (Licensed Narrowband)

### Antennas:

LN transceivers may be used with a number of different antennas. The exact style and gain factor depend on regulatory constraints and the physical size/layout of your system. Connection is made to the radio via a TNC coaxial connector. A directional Yagi (Figure 2-12) or corner reflector antenna is generally used at remote sites to minimize interference to and from other users. Antennas of this type are available from several manufacturers, including GE MDS. Contact your sales representative for details.

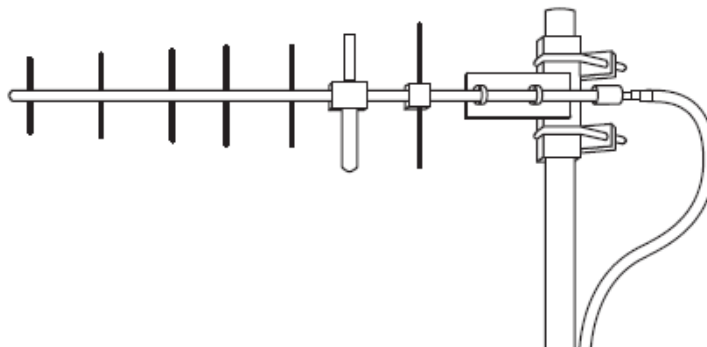


Figure 2-12. Typical Yagi Antenna (mounted to mast)

### Feedlines:

Selection of an antenna feedline is very important. Poor quality cable should be avoided as it will result in power losses that may reduce the range and reliability of the radio system. The tables which follow show the approximate losses that will occur when using various lengths and types of coaxial cable. Regardless of the type used, the cable should be kept as short as possible to minimize signal loss.

Table 2-7. Signal Loss In Coaxial Cables (at 400 MHz)

Cable Type	10 Feet (3 Meters)	50 Feet (15 Meters)	100 Feet (30.5 Meters)	200 Feet (61 Meters)
RG-8A/U	0.51 dB	2.53 dB	5.07 dB	10.14 dB
½ inch HELIAX	0.12 dB	0.76 dB	1.51 dB	3.02 dB
7/8 inch HELIAX	0.08 dB	0.42 dB	0.83 dB	1.66 dB
1-1/4 inch HELIAX	0.06 dB	0.31 dB	0.62 dB	1.24 dB
1-5/8 inch HELIAX	0.05 dB	0.26 dB	0.52 dB	1.04 dB



**Table 2-8. Signal Loss In Coaxial Cables (at 900 MHz)**

Cable Type	10 Feet (3 Meters)	50 Feet (15 Meters)	100 Feet (30.5 Meters)	500 Feet (152 Meters)
RG-214	0.76 dB	3.80 dB	7.60 dB	Unacceptable Loss
LMR-400	0.39 dB	1.95 dB	3.90 dB	Unacceptable Loss
1/2 inch HELIAX	0.23 dB	1.15 dB	2.29 dB	11.45 dB
7/8 inch HELIAX	0.13 dB	0.64 dB	1.28 dB	6.40 dB
1-1/4 inch HELIAX	0.10 dB	0.48 dB	0.95 dB	4.75 dB
1-5/8 inch HELIAX	0.08 dB	0.40 dB	0.80 dB	4.00 dB

## Accessories and Spares

The table below lists common accessories and spare items for use with the MCR. GE MDS also offers an *Accessories Selection Guide* listing an array of additional items that may be used with the product. Contact your factory representative or visit [www.gemds.com](http://www.gemds.com) to obtain a copy of the guide.

**Table 2-9. Accessories & Ancillary Items**

Item	Description	Part Number
DC Power Plug, 2-pin, polarized	Mates with power connector on the unit's case. Screw terminals are provided for wires, threaded locking screws to prevent accidental disconnect.	73-1194A53
Setup Guide (for installation instructions)	Describes the installation and setup of the unit. It is a companion to this Technical Manual. PDF copy available free at <a href="http://www.gemds.com">www.gemds.com</a> .	05-6709A01
Flat Mounting Bracket Kit	Brackets that attach to the bottom of the unit, used for mounting to a flat mounting surface.	03-4123A14
COM Port Adapter	Converts the unit's RJ-45 serial jack to a DB-9F type.	73-2434A25
Mini USB 2.0 Cable, 3 ft	USB Type A (M) to mini-USB Type B (M) cable to provide console access through the radio's mini USB connector.	97-6694A05
DIN Rail Mounting Kit	Hardware for DIN Rail Mounting	03-4125A06





## 3.0 Device Management

This section describes the steps for connecting a PC, logging in and setting unit parameters. The focus here is on the local serial console interface, but other methods of connection are available and offer similar capabilities. The key differences are with initial access and appearance of data.

The MCR offers several interfaces to allow device configuration and monitoring of status and performance. These include local serial console, USB, NETCONF, HTTPS and Secure Shell (SSH) for local and remote access via the WAN and LAN networks. The serial console, USB and SSH services offer a command line interface (CLI). There are three user accounts/roles for management access: admin, tech and oper. User accounts can be centrally managed with a RADIUS server. RADIUS accounts can be mapped to one of the three user accounts/roles (See “User Management and Access Controls” on Page 165).

---

**NOTE** The Orbit MCR device is designed for high security environments. As such, management of the device does not support Telnet, but instead implements the more secure SSH protocol.

---

Configuring and managing the Orbit MCR is done by changing configuration data via the Web User Interface (UI) or from the Command Line Interface (CLI). Either way requires two steps. The first step is to use a user interface to add, remove, or alter a piece of configuration data. The second step is to use the user interface to *commit* the change. Multiple changes can be made prior to committing them. This two-step process allows users to make multiple changes to the configuration and apply them in a bulk commit. Additionally, the device can validate the bulk commit and reject it if there is an error.

The *Device Manager* is a built-in software tool that works with your PC’s browser to provide an intuitive, web-style presentation of all unit information, settings, and diagnostics. Web management uses the unit’s Ethernet RJ-45 connector

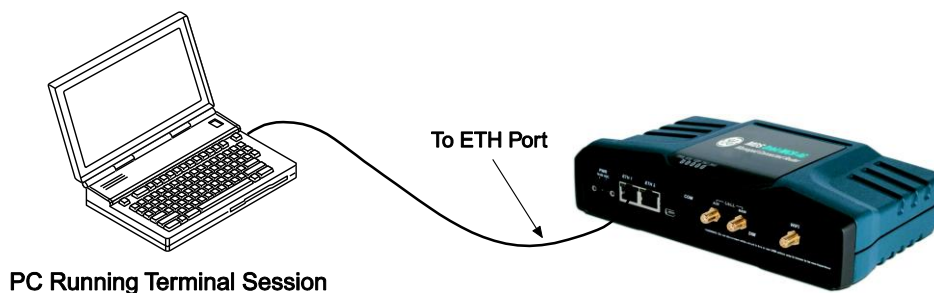
---

**NOTE** For security, web access can be enabled/disabled via the CLI using the command: `% set services web http(s) enabled true/false`

---

To connect to the unit and manage it via the Device Manager, you will need the following:

- A PC with a web browser program installed.
- An Ethernet cable connected between the PC and the MCR as shown in PC Connection for Web Management.
- The unit’s IP address. Check with your Network Administrator, or determine the address via a command line interface connection. The default address for a factory supplied unit is 192.168.1.1.
- The user name and password for the unit. Check with your Network Administrator, or, if a username and password have not been set, use the factory defaults of admin for both entries. (For security, a new password should be established as soon as possible after login.)



**Figure 3-1. PC Connection for Web Management**

Use of a modern browser is highly recommended.



**Table 3-1. Browser Support**

Browser Type	Version
Microsoft™ Internet Explorer	9.x or newer
Mozilla Firefox	Mozilla Firefox
Apple Safari (Mac OS X only)	Apple Safari (Mac OS X only)
Google Chrome	26.x or newer

## Logging On

1. Connect the unit to a PC via an Ethernet connection.
2. Configure your PC network settings to an IP address on the same subnet as the unit. The default subnet mask is 255.255.255.0.

---

**NOTE** For IP addressing the Orbit MCR uses a routing prefix expressed in CIDR notation instead of the specifying a subnet mask. The CIDR notation is the first address of a network, followed by a slash character (/), and ending with the bit-length (max 32) of the prefix. A subnet mask is expressed in dot-decimal notation. For example, 192.168.1.0/24 is equivalent to specifying 192.168.1.0 with a subnet mask of 255.255.255.0.

---

3. Enter the unit's IP address in a web browser window, just as you would enter a website address. When the login screen appears (Figure 3-2. Login Screen), enter the User Name and Password for the unit. The default entries for a new unit are both admin. Click OK.

The image shows a web browser login screen with a light blue background. At the top center, the text "Sign in" is displayed in a bold, dark font. Below this, the label "Username:" is followed by a text input field containing the placeholder text "Username". Underneath, the label "Password:" is followed by a text input field containing the placeholder text "Password". At the bottom center, there is a rectangular button with the text "Sign in" on it.

**Figure 3-2. Login Screen**

## Getting an Overview of Unit Settings

To get a top-level view of the key settings and operating parameters for the unit, select Home in the upper left hand side of the screen and a summary screen will be displayed. When finished, log out of the Device Manager by clicking Logout in the upper right hand side of the screen.



The screenshot shows the GEMDS Device Manager interface for an MDS-3G device. The top navigation bar includes 'Save', 'Rollback', 'CLI', and 'Logout' buttons, along with the GE logo and 'Digital Energy MDS' branding. A left sidebar contains a menu with options: Wizards, System, Interfaces, Services, Routing, Logging, Certificate Management, and Management. The main content area is titled 'Device Overview' and is divided into three sections: 'Summary', 'Current Alarms', and 'Interfaces'. The 'Summary' section lists device details: Name (MDS-3G), Contact (EAP), Product Configuration (MXCT3G1NW51NNS1F4NUNE), and Serial Number Platform (2344645). The 'Current Alarms' section is currently empty. The 'Interfaces' section contains a table with columns for Name, Type, Admin Status, Oper Status, IP Addresses, and MAC.

Name	Type	Admin Status	Oper Status	IP Addresses	MAC
Bridge	bridge	up	up	10.10.10.141/23 (static)	00:06:3d:07:96:82
Cell	cellular	up	down		
ETH1	ethernet	up	up		00:06:3d:07:96:82

Figure 3-3. Device Manager, Overview Screen

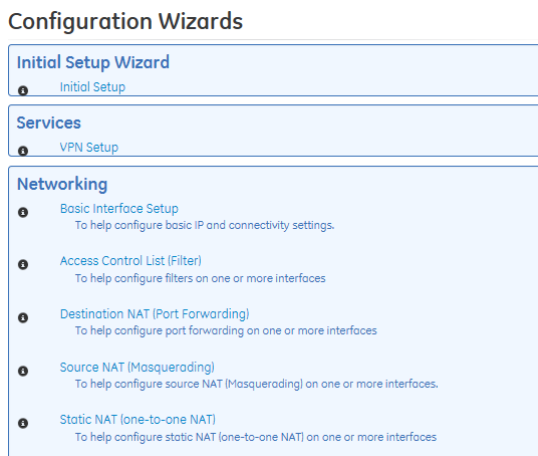
For initial configuration, the Setup Wizard will appear and provide guidance in typical setups. This will be disabled after initial setup is completed, but may be re-run at any time from the **Wizards** page.

The screenshot shows the 'Setup Wizard' starting page in the GEMDS Device Manager. The interface is similar to the overview screen, with the same top navigation bar and left sidebar. The main content area is titled 'Setup Wizard' and 'MDS Orbit General Configuration Wizard'. It lists the wizard's purpose: 'This wizard provides set-up support for: 1. System Information, 2. Password Configuration, 3. System Time Setup, 4. DNS Setup'. A note states 'A summary of all the changes will be provided at the end.' At the bottom, there are 'Cancel', 'Back', and 'Next' buttons.

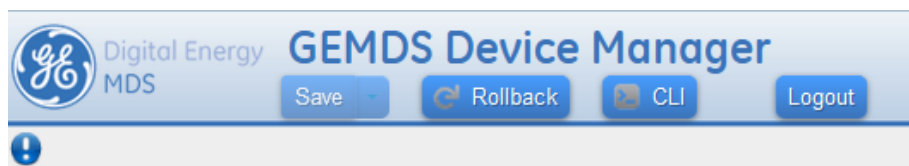
Figure 3-4. Initial Setup Wizard Starting Page



In addition to the Setup Wizard other Configuration Wizards are available to assist Services and Networking. The Basic Interface Setup wizard can be particularly helpful for initial device configuration.

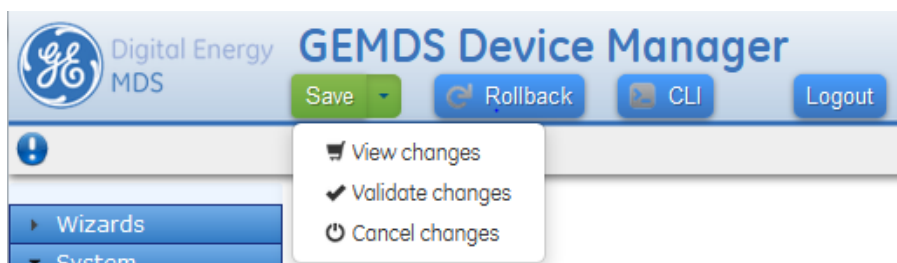


From the Web UI changes made on the screens are not saved or implemented until via the save button or commit command. The **Save** button in the banner on the top left of every page. Normally this is not highlighted and blue in color as shown below:



**Figure 3-5. Save Button—No changes to commit**

When there are changes to commit, the button is highlighted and colored green. Options available are: View, Validate and Cancel. Clicking the button defaults to Validate and saves the changes.



**Figure 3-6. Save Button—Changes to commit**

From the CLI, all changes are made and committed using by using the commit command and enter.

`% commit`

## 3.1 Initial Settings Overview

### 3.1.1 Setting Basic Parameters—First Steps

There are three tasks that should be performed after initial startup and connection to a PC, as follows:

1. Create One-Time Programmable passwords for device recovery in the event a password is lost.
2. Change the login passwords.
3. Evaluate the default factory configuration and set it to the user's required security level.

### 3.1.2 One-Time “Recovery” Passwords

The MDS Orbit platform employs extensive security measures to prevent unauthorized access. As such, there are no hidden manufacturer passwords or other “back doors” found in less secure products. If a



password is lost, there is no way to access the unit, except by using a one-time password (OTP) for recovery. This must be established by the user beforehand. Without a one-time password, the unit will not be accessible and the hardware will need to be returned to the factory to be re-imaged to defaults.

**Technical Support will not be able to assist you if a password is lost, so creating a one-time password is strongly encouraged. A device with a lost password**

Refer to instructional video:

[https://www.youtube.com/watch?v=qHiFg-QZP\\_Q&list=UUWEcxa9\\_FSdEqowzxNbNLsw&index=35](https://www.youtube.com/watch?v=qHiFg-QZP_Q&list=UUWEcxa9_FSdEqowzxNbNLsw&index=35)

Associated QR Code:



## One-Time Passwords: How They Work

One-time recovery passwords put control directly and exclusively in the user’s hands. They are similar to spare keys for a lock. If you make a spare key and put it away safely, you can take it out to quickly gain entry when your primary key is lost. If you don’t make a spare, you are always at risk of locking yourself out.

A one-time recovery password is different from the one used to log into the unit on a routine basis. It is *only* for use when the primary password is lost or forgotten. When a one-time password is used to log in, that password is *automatically revoked* from the list of passwords created. You may create up to five one-time passwords at one time and more can be created if some get used. A password cannot be used again for log in to the unit, hence the name “one-time” password.

**NOTE** One-time passwords are only displayed at the time of creation. The password must be saved and archived at that time. There is no way to view this password again.

The screenshot shows the 'Setup Wizard' interface for 'GEMDS Device Manager'. The main heading is 'One Time Passwords Setup'. Below this, there is a text box explaining that creating an OTP can help recover the device. A dropdown menu is set to 'factory-reset' with a 'Generate OTP' button next to it. Below the button is a table with the following data:

Identifier	Type	Passwords
4	login	6CkG2GNZumalFzUinc8Mf7jD6sGjQqSJ8c/7hFM6F2RzSoBGQnx1Yg==
5	factory-reset	VaQITm3aWGE7yj9E04MaDXKV+geP7A85AGwpnu4y5WyAb8DeK0X8Hw==

At the bottom of the table area are 'Cancel', 'Back', and 'Next' buttons.

**Figure 3-7. One-Time Password Add in Setup Wizard**

## Logging in With a One-Time Password



Logging in with a one-time password can only be performed from the local serial or USB console. You cannot use a one-time password when connecting to the unit remotely. To use the one-time password for log-in, proceed as follows:

1. At the username prompt, enter the word recovery.





2. At the password prompt, paste in the one-time-password saved earlier on your PC. Using a one-time-password forces the unit to perform the function which was previously defined when the password was created:
  - **factory-reset** — The unit resets its entire configuration to factory defaults
  - **login** — The unit allows logging in with admin privileges

*Special case:* If someone has disabled console access on the COM port, the login prompt will still be present on that console, but only one-time passwords will be accepted. This is done to provide a way to recover the unit in the case where the COM1 port has been disabled and the unit cannot be accessed via TCP (for example; SSH).

## Deleting a One-Time Password

As noted earlier, a one-time password is automatically revoked when it is used for log-in. A revoked password may be replaced, but it must first be removed from the list so a new one can be generated. Any of the five stored passwords may be removed on demand. As long as there is a free slot, an additional password can be created, up to the maximum number of five. Logs are generated when the user creates, deletes or logs in with a one-time-password.

## Managing One-Time Passwords

One-Time passwords can be created as part of the Initial Setup Wizard, as shown in the example below.

To view currently configured One-Time Passwords, navigate to

**Troubleshooting ---> Status / Recovery Information / Passwords**

**Troubleshooting** ↻

Status Basic Config Advanced Config Actions

---

Recovery Information

**Snapshots**

Search [X] [Signal] [Refresh] [Search] [Edit]

Identifier	Description	Date	Version	Hash
Factory	Factory Default Configuration	2013-01-01T00:21:40+00:00	1.4.3	0xe3a9ea67f8e7662c908b78618d661414
Auto	Automatic snapshot for 2.0.8	2014-11-26T11:01:53-05:00	2.0.8	0x05813746dc003f7ec640fe30161bdae6

Showing 1 to 2 of 2

**Passwords**

Search [X] [Signal] [Refresh] [Search] [Edit]

Identifier	Function	Status	Date Created	Date Revoked	User
1	login	usable	2012-12-31T19:32:14-05:00		
2	factory-reset	usable	2014-05-22T10:23:13-04:00		
3	factory-reset	usable	2014-05-23T13:23:26-04:00		
4	login	usable	2014-11-26T11:05:21-05:00		
5	factory-reset	usable	2014-11-26T11:05:25-05:00		

Showing 1 to 5 of 5

**Figure 3-8. One-Time Password Display Screen**

To edit or delete (revoke) a One-Time Password, navigate to:

**Troubleshooting ---> Actions / One Time Passwords**



## Troubleshooting

Status Basic Config Advanced Config **Actions**

Power  
Recovery  
One Time Passwords

**Create**

Function \*

Perform action

**Delete**

Identifier \*

Perform action

**Figure 3-9. One Time Passwords Management Screen**

Up to 5 passwords may be added. They may also be deleted. Remember to replace a used password which is automatically revoked. It must be deleted if there are no more password slots available.

### 3.1.3 Change Default Passwords

For security purposes it is highly advised to change the default passwords for all user roles. This is accomplished on the “Change Password” Screen shown below located at:

*User Authentication ---> Actions / Change Passwords*

User Authentication

Status Basic Config Advanced Config **Actions**

Change Password

**Change Password**

User \*

Password \*

Perform action

**Figure 3-10. Change User Password Screen**

This feature is also a part of the Initial Setup Wizard, as shown in the Figure below.



**Figure 3-11. User Password Initial Setup Wizard Change Screen**

The selected password(s) must follow the rules established on the “Password Options” screen located under the *Basic Config* tab of the *User Authentication* section. These rules may be modified to conform to the local security requirements.

### 3.1.4 Security Review

The Orbit MCR provides strong cyber security capabilities that may be customized to meet enterprise security policy requirements. By default the Orbit MCR is configured with a light level of security. There are many features and parameters that should be considered and adjusted according to the security policy. Some of the areas to consider are:

1. User Authentication
  - Update factory default passwords.
  - Secure login access into Orbit with local or RADIUS based user authentication.
2. Device Management
  - Secure access to Orbit for device management by enabling/disabling HTTP/HTTPS/SSH.
  - It is recommended that HTTP be disabled.
  - It is recommended that SNMPv1/v2c be disabled and SNMPv3 be enabled
3. Static Routing - Limit local broadcast and multicast traffic from being shared with specified interfaces.
4. Packet Filtering – Prevent ingress/egress of unwanted traffic by configuring firewall/NAT.
5. Secure end-to-end network links using IPsec VPN with pre-shared-key or certificate based setup.
6. Cellular Security – Utilize IPsec VPN to secure end-to-end cellular link over public cellular networks.
7. WiFi Security – Secure Wi-Fi link with pre-shared key or EAP-TLS/RADIUS using certificates.
8. NX915 Security – Secure 900MHz link pre-shared key or EAP-TLS/RADIUS using certificates.



9. LN Security – Secure Licensed Narrowband link pre-shared key or EAP-TLS/RADIUS using certificates.
10. Event Logging – Securely send event logs to central SYSLOG server by configuring SYSLOG over TLS.
11. PKI/Certificate Management – Generate/upload private keys/certifications for use in certificate based security setup.
12. Tamper Detection – Enable tamper detection to detect unauthorized device enclosure removal and physical movement from authorized install site.

## 3.2 Preconfigured Settings

The GE MDS factory configuration establishes typical settings based on the types of modules ordered.

The intent is to provide as much out-of-box functionality as possible. For example, in WiFi/Cell configurations, the unit is configured as a WiFi hotspot.

- The Orbit MCR is highly configurable to meet field requirements, but comes preconfigured as follows:
  - The COM and USB ports are enabled for local console operation.
  - When applicable, interfaces are preconfigured as members of a bridge.
  - A DHCP server is enabled for WiFi clients and the Ethernet LAN ports.
- Units are configured with a set of pre-defined defaults set by the factory.
  - Default Ethernet IP address **192.168.1.1**
  - Firewall/NAT/DNS proxy enabled
  - DHCP server enabled

### Other defaults

- WiFi (hotspot):
  - Set as Access Point (AP)
  - SSID = GEMDS\_<SERNUM> SERNUM refers to the unit's serial number, printed on a chassis sticker.
  - The Ethernet ports are bridged with the WiFi AP.
  - SSID broadcast enabled
  - Security = WPA2-PSK, CCMP with passphrase: **GEMDS\_ORBIT**
- Cellular modem:
  - 4G Cellular interface is enabled by default since network can enable connectivity on default APN.
  - 3G Cellular interface is disabled by default since it requires carrier specific APN to be configured.
- ISM Unlicensed 900 MHz radio (NX915):
  - Radio Mode set to **Remote**
  - Modem Mode 500kbps
  - Power at 30 dBm
- Licensed Narrowband radio (LN400/LN900):



- Radio Mode set to **Remote**
- Adaptive Modulation enabled
- FEC set to low gain
- Power at 40 dBm

These configuration settings allow a connection to a PC to the unit via WiFi or the LAN port and access to the Internet via cellular, if equipped and supported by a suitable service plan.

### 3.3 Specific Application Examples Using Device Manager

The following examples illustrate the set of steps to configure the MCR for specific scenarios. The “Step” column is the high level concept, The “Manual Section” provides a link to the manual section that can explain in more detail and the “Comment...” column provides additional information or specific settings pertinent to the example. More examples can be found in **05-6909A01 Orbit MCR Cookbook** available on the GE MDS website.

#### Initial Setup Example

During the initial configuration of a device the following checklist in Table 3-2 should be consulted to commission the unit for operation.

Table 3-2. Checklist for Initial Setup/Configuration

Step	Applicable Manual Section	Comment / Additional Information
Establish connection to the device (SSH/ Serial/ USB/ Web)	Initial Settings Overview Specific Application Examples Using Device Manager Using the Command Line Interface (CLI)	With serial/USB/SSH interfaces the "Command Line Interface" (CLI) is provided.
Create One-Time Programmable passwords for device recovery in the event a password is lost	One-Time “Recovery” Passwords	This is extremely important for recovering a unit if a admin password is lost. Note - this is part of the Initial Setup Wizard
Change the login passwords/configure users	Change Default Passwords	For security purposes it is highly recommended that password for all user type be changed from their defaults. Note - this is part of the Initial Setup Wizard
Review factory default configuration	Preconfigured Settings	
Disable DHCP if using Static IP Addresses for WiFi and Ethernet port(s)	3.8.13 - DHCP Service	
Set Date /Time or NTP Server	3.7.1 - Date, Time and NTP	Note - this is part of the Initial Setup Wizard
Set Geographic Location (if desired)	3.7.2- Geographical-location	Note - this is part of the Initial Setup Wizard

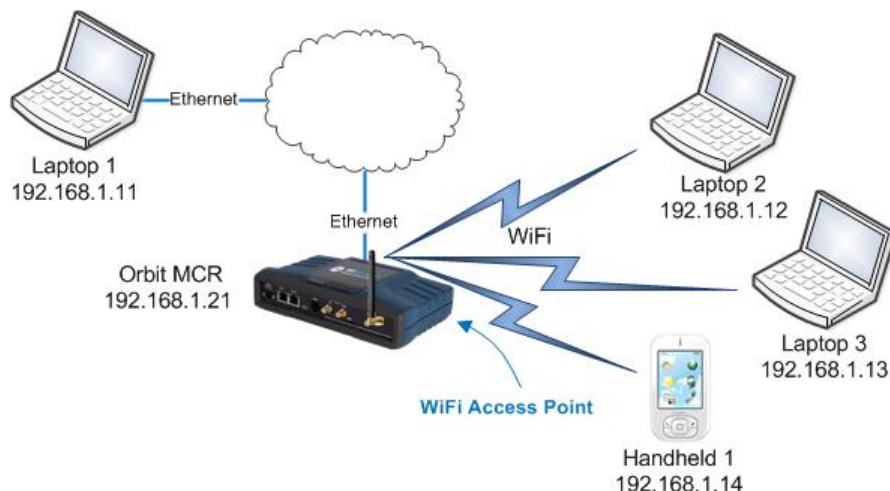


Step	Applicable Manual Section	Comment / Additional Information
Configure WiFi (if present)	3.5.3 - WiFi	
Configure Cell interface (if present)	3.5.2 - Cell 10.0 - APPENDIX E – Obtaining Provisioned 4G/LTE Service (Verizon)	A guide to setting up cellular service in the listed Appendix
Configuring for 900MHz operation (if present)	3.5.4 - Unlicensed 900 MHz ISM (NX915)	NX915 is the hardware module that provides the 900 MHz operations. It is factory configured based on country codes for legal operations.
Configuring for Licensed Narrowband operation (if present)	3.5.5 - Licensed Narrowband (LN)	LNxxx hardware modules provide operation in various global frequencies from 400 MHz to 960 MHz. User configuration is required to match conditions of license.



## Application Example #1

In the figure below, the Orbit MCR is functioning as a WiFi Access Point to provide connectivity between a set of laptops and a handheld device. The MCR is also acting as a DHCP server for the laptops and handheld device.



**Figure 3-12. Example 1: Unit Providing Laptop and Handheld Device Connectivity**

By default the unit is configured in this basic configuration. Refer to Preconfigured Settings for accessing the unit using the default setting for the Ethernet ports, WiFi and the bridge.

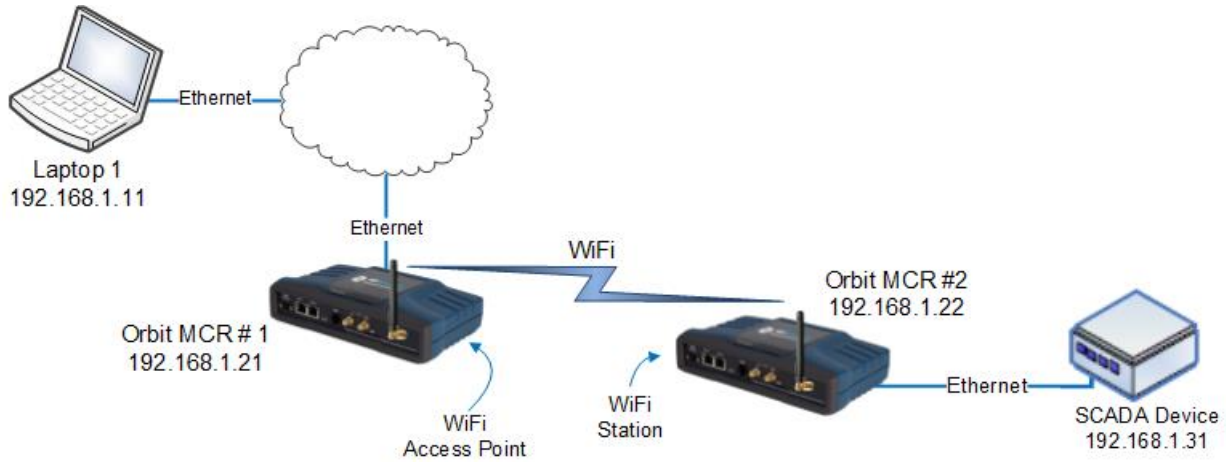
The following chart lists the required steps to configure the MCR for this specific scenario. Note that for each step the linked manual section is provided as well as detailed information for use in recreating the example.

Step	Applicable Manual Section	Comment / Additional Information
Configure WiFi	3.5.3 - WiFi	Enable unit as Access Point Set SSID <i>mysid</i>
Configure network	3.8.5 - Bridging	Add <i>ETH1</i> and <i>WiFi</i> to the bridge
Set the Bridge IP address	3.8.5 - Bridging	Set ipv4 address <i>192.168.1.21</i> Set prefix-length <i>24</i>
Configure DHCP Server	3.8.13 - DHCP Service	Set v4subnet <i>192.168.1.0/24</i> Set domain-name <i>gemds</i> Set range-start <i>192.168.1.10</i> Set range-end <i>192.168.1.19</i> Set router <i>192.168.1.1</i> Set broadcast-address <i>192.168.1.255</i>



## Application Example #2

In the figure below, there are two Orbit MCR devices, one acting as a WiFi Access Point, the other as a WiFi Station. Together, they provide a wireless bridge between the laptop and the SCADA device.



**Figure 3-13. Example 2: Units Providing Wireless Bridge Between Laptop & SCADA Device**

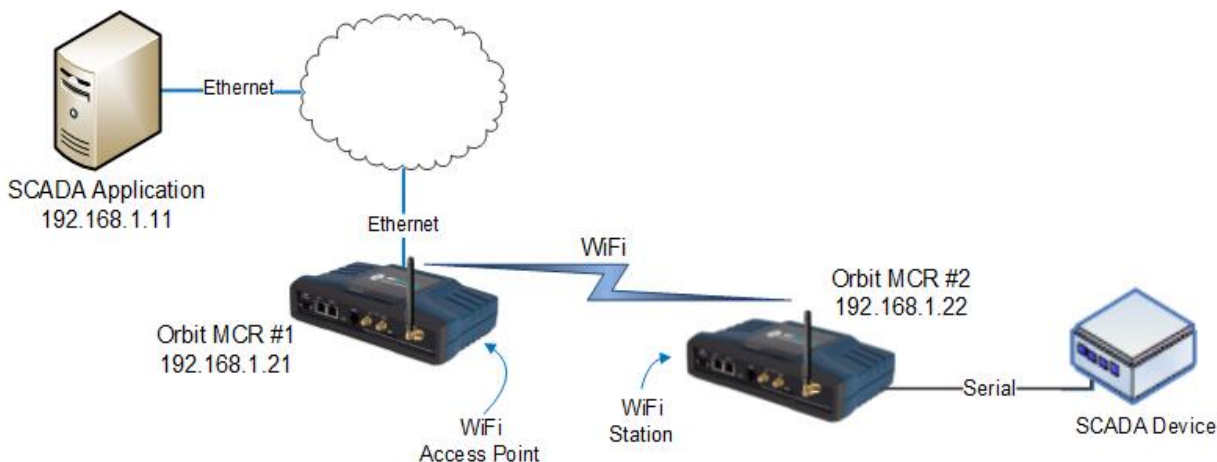
Step	Applicable Manual Section	Comment / Additional Information
Orbit MCR #1: Configure WiFi as an Access Point	3.5.3 - WiFi	Enable Access Point mode Create SSID of <i>myssid</i>
Orbit MCR #1: Configure to bridge traffic from ETH1 and WiFi	3.8.5 - Bridging	Add <i>ETH1</i> and <i>WiFi</i> to the bridge
Orbit MCR #1: Set bridge IP address	3.8.5 - Bridging	Set to <i>192.168.1.21</i> prefix-length <i>24</i>
Orbit MCR #1: Enable DHCP Server on bridge	3.8.13 - DHCP Service	Set <i>v4subnet</i> <i>192.168.1.0/24</i> Set <i>domain-name</i> : <i>gemds</i> Set <i>range-start</i> : <i>192.168.1.10</i> Set <i>range-end</i> : <i>192.168.1.19</i> Set <i>router</i> : <i>192.168.1.1</i> Set <i>broadcast-address</i> : <i>192.168.1.255</i>
Orbit MCR #2: Configure WiFi as an Station connecting to Orbit MCR #1	3.5.3 - WiFi	Enable Station mode Connect to AP SSID of <i>myssid</i>
Orbit MCR #2: Configure to bridge traffic from ETH1 and WiFi	3.8.5 - Bridging	Add <i>ETH1</i> and <i>WiFi</i> to the bridge
Orbit MCR #2: Set bridge IP address	3.8.5 - Bridging	Set to <i>192.168.1.22</i> prefix-length <i>24</i>





### Application Example #3

The figure below shows the Orbit MCR #2 device acting as a terminal server to provide connectivity to the serial-based SCADA device via UDP.



**Figure 3-14. Example 3: Unit Providing Connectivity to Serial-Based SCADA Device via UDP**

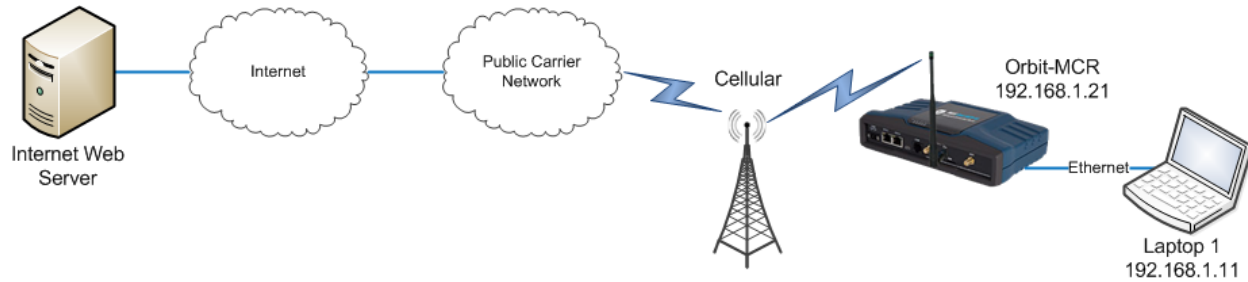
**NOTE** The configuration for Orbit MCR #1 in Example 3: Unit Providing Connectivity to Serial-Based SCADA Device via UDP is identical to the configuration shown in the previous example (Example #2).

Step	Applicable Manual Section	Comment / Additional Information
Orbit MCR #1: Configure WiFi as an Access Point	3.5.3 - WiFi	Enable Access Point mode Create SSID of <i>myssid</i>
Orbit MCR #1: Configure to bridge traffic from ETH1 and WiFi	3.8.5 - Bridging	Add <i>ETH1</i> and <i>WiFi</i> to the bridge
Orbit MCR #1: Set bridge IP address	3.8.5 - Bridging	Set to <i>192.168.1.21</i> prefix-length <i>24</i>
Orbit MCR #1: Enable DHCP Server on bridge	3.8.13 - DHCP Service	Set <i>v4subnet</i> <i>192.168.1.0/24</i> Set <i>domain-name</i> <i>gemds</i> Set <i>range-start</i> <i>192.168.1.10</i> Set <i>range-end</i> <i>192.168.1.19</i> Set <i>router</i> <i>192.168.1.1</i> Set <i>broadcast-address</i> <i>192.168.1.255</i>
Orbit MCR #2: Configure WiFi as a Station connecting to Orbit MCR #1	3.5.3 - WiFi	Enable Station mode connect to AP SSID of <i>myssid</i>
Orbit MCR #2: Configure to bridge traffic from ETH1 and WiFi	3.8.5 - Bridging	Add <i>ETH1</i> and <i>WiFi</i> to the bridge
Orbit MCR #2: Set bridge IP address	3.8.5 - Bridging	Set to <i>192.168.1.22</i> prefix-length <i>24</i>
Set up Terminal Server COM1	3.8.14 - Terminal Service	Set mode <i>udp</i> port <i>30000</i> remote addr: <i>192.168.1.11</i> port <i>30001</i>



## Application Example #4

In the figure below, an Orbit MCR provides internet access for a laptop that is accessing a public web page.



**Figure 3-15. Example 4: Unit Providing Internet Access for Laptop**

SIM Type: In this scenario, the MCR-4G has a SIM card installed that simply provides Internet access.

Step	Applicable Manual Section	Comment / Additional Information
Configure ETH1 to be in Bridge	3.8.5 - Bridging	Add <i>ETH1</i> to the bridge.
Configure Bridge for an IP address	3.8.5 - Bridging	Set address to <i>192.168.1.1</i> prefix length <i>24</i>
Enable the firewall for local address space	3.8.8 - Access Control List (Packet Filtering / Firewall)	Enable firewall
Configure the incoming out of network address to accept only ICMP	3.8.8 - Access Control List (Packet Filtering / Firewall)	Set Rule <i>1</i> protocol <i>ICMP</i> , Action <i>accept</i>
Configure the incoming out of network address to drop all other traffic (IN_UNTRUSTED)	3.8.8 - Access Control List (Packet Filtering / Firewall)	Set Rule <i>10</i> protocol <i>all</i> , Action <i>drop</i>
Configure the outgoing destination to allow local network (OUT_UNTRUSTED)	3.8.8 - Access Control List (Packet Filtering / Firewall)	Set Rule <i>1</i> src Address: <i>LOCAL-NETS</i> Add Interface address; <i>true</i> Action <i>accept</i>
Configure the outgoing destination to drop other network destined packets (OUT_UNTRUSTED)	3.8.8 - Access Control List (Packet Filtering / Firewall)	Set Rule <i>10</i> protocol <i>all</i> Action <i>drop</i>
Enable Firewall NAT to masquerade	3.8.8 - Access Control List (Packet Filtering / Firewall)	rule-set: <i>MASQ</i>
Enable Firewall NAT rule	3.8.9 - Source NAT (Masquerading)	Set Rule <i>1</i> source-nat : <i>interface</i>
Enable Cell interface	3.5.2 - Cell	
Apply Firewall IN_UNTRUSTED and OUT_UNTRUSTED filters to Cell interface	3.8.8 - Access Control List (Packet Filtering / Firewall)	Set Cell input filter to <i>IN_UNTRUSTED</i> Set Cell output filter to <i>OUT_UNTRUSTED</i>
Set NAT on Cell interface to masquerade	3.8.9 - Source NAT (Masquerading)	Set cell NAT source to <i>MASQ</i>



## 3.4 Using the Command Line Interface (CLI)

### 3.4.1 Differences between Serial and SSH

Serial and SSH both present identical management capabilities, but the method of access is different for each. Serial involves an RS-232 serial connection from a PC to the unit's COM port. SSH uses an Ethernet PC connection to the unit's ETH port. Maximum recommended cable length for a serial connection is 50 feet (15 meters). SSH can be connected to the unit from any network point that has connectivity with the PC, including remotely over the Internet, or using other networks.

The focus of these instructions is on *Serial* access, but SSH may also be used by following these additional points, which replace Steps 1-3 below:

- Connect to the unit with a PC that is in the same IP network as the MCR. Launch an SSH client program and connect to the unit using its programmed IP address.
- The default IP address for the unit is 192.168.1.1. If you do not know the current IP address of the unit, follow the serial configuration instructions below, where you can determine the address and continue configuration, or check with your network administrator.

### 3.4.2 Establishing Communication—Serial Interface

Follow these steps to configure the unit for its first use with serial console interface:

1. Connect a PC to the unit's COM port as shown in Figure 3-16. Maximum recommended cable length is 50 ft/15 m.

---

**NOTE** Not all PCs include a serial port. If one is not available, the Orbit MCR's USB port can be used to access the device management console by using a Mini-USB cable between the device and a PC. The PC needs to install the device driver.

---

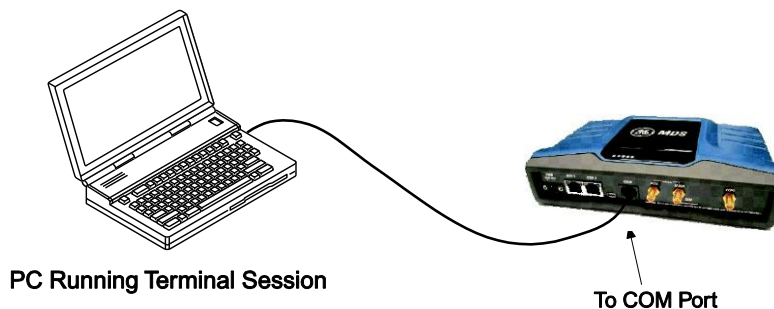
---

**NOTE** If the COM port has been configured for terminal server operation, pressing +++ switches it to console (management) mode. Serial console mode is required for the following steps.

---

Launch a terminal communications program, such as HyperTerminal, with the following communication parameters: 115200 bps (default speed), 8 bits, no parity, one stop bit (8N1) and flow control disabled. Incorrect parameter settings are a frequent cause of connection difficulties. Double check to be sure they are correct.

An adapter may be used to convert the unit's RJ-45 serial jack to a DB-9F type (GE MDS part no. 73-2434A12). If no serial port exist on the PC, a Mini-USB cable may be connected between the MCR's USB device port and the PC.



**Figure 3-16. PC Connection for Programming/Management**

2. Press the **ENTER** key to receive the Login: prompt. This indicates that the unit is ready to receive commands.
3. At the Login: prompt, enter admin (lower case) and press **ENTER**.



4. If no password has been previously set, enter the default password (admin) and press **ENTER** ; otherwise, enter the saved password at the Password: prompt. (Before placing the unit in final service, it is recommended that the default password be changed to ensure that only authorized users have access.)
5. After successful login, the command prompt appears where you may configure and manage a number of unit settings.

### 3.4.3 Using the CLI

This section describes how to use the CLI by using an example: changing the name of the unit.

Step 1: Login to the device using the serial console and use the default username admin and the default password admin.

```
(none) login: admin
Password:
Welcome to the CLI
admin connected from 127.0.0.1 using console on (none)
```

Step 2: Instruct the device to enter configuration mode by typing configure and pressing the enter key:

```
> configure
Entering configuration mode private
```

Step 3: Change the device name by typing in the following, followed by enter: set system name Device539

```
% set system name Device539
```

Step 4: Verify the change looks correct by reading the data back, using the following, followed by the enter key: show system name

```
% show system name
name Device539;
```

Step 5: Commit the change by typing in the following, followed by the enter key: commit

```
% commit
Commit complete.
```

Step 6: Exit the configuration mode by typing the following, followed by the enter key: exit

```
% exit
```

Step 7: Exit the login session by typing the following, followed by the enter key: exit

```
> exit
Device539 login:
```

### Tab Completion Feature

Tab-completion is a powerful feature that presents CLI users with assistance while typing. Depending on the text that was already entered, tab-completion will display different possible completions. When the tab key is pressed and no text has been entered, the CLI shows all possible commands that can be typed.

### Creating a One-Time Password

To create a one-time recovery password, proceed as follows:

- Upon successful log-in, enter the following command:  

```
> request system recovery one-time-passwords create function <selected function>
```



**NOTE** A one-time password is automatically generated and displayed on the screen. Copy this password and save it in the desired location on your PC. There is no way to ever view it again from the command line console, so be sure it is properly saved.

- To create additional one-time passwords (up to a total of five), repeat the step above.

### Deleting a One-Time Password

To remove an existing password from the list, proceed as follows:

Enter the command request system recovery one-time-passwords delete identifier X, where X is a number from the currently available one-time passwords. This identifier is not reused. If all five passwords have been created, then ID 1 can be deleted and the next created password will be at ID 6.

The current list of passwords may be viewed by issuing the command show system recovery one-time-passwords. The following is an example output from that command. On the unit shown, only two passwords have been stored. Password 1 or 2 can be deleted from this list.

IDENTIFIER	FUNCTION	STATUS	DATE CREATED	DATE REVOKED	USER
1	login	usable	2012-06-19T00:27:24+00:00		
2	login	usable	2012-06-19T00:27:25+00:00		

### 3.4.4 CLI Quick Reference Table

Table 3-3 provides a summary listing of commonly needed tasks and the appropriate commands to enter. The table can be used as a quick reference before consulting the more detailed information, which follows in this section. Each CLI command is preceded by the symbol > for operational command, or % for a configuration command.

**Table 3-3. CLI Quick Reference Table**

If you wish to...	Enter this CLI command:
Create a one-time password	> <b>request system recovery one-time-password create function &lt;user function&gt;</b>
View all network interface status and statistics	> <b>show interfaces-state interface</b>
Create a bridge	% <b>set interfaces interface Bridge type bridge</b>
Add the ETH1 interface to a bridge	% <b>set interfaces interface Bridge bridge-settings members port ETH1</b>
Remove the ETH1 interface from a bridge	% <b>delete interfaces interface Bridge bridge-settings members port ETH1</b>
Set WiFi AP SSID	% <b>set interfaces interface Wi-Fi wifi-config mode access-point ap-config ap myssid</b>
Enable WiFi WPA2-Personal security	% <b>set interfaces interface Wi-Fi wifi-config mode access-point ap-config ap myssid privacy-mode wpa2-personal psk-config psk mypassphrase encryption ccmp</b>
Enable WiFi SSID Broadcasting	% <b>set interfaces interface Wi-Fi wifi-config ap-config ap myssid broadcast-ssid true</b>
View Cell Settings	> <b>show configuration interfaces interface Cell cell-config</b>
Monitor Cell Status	> <b>show interfaces-state interface Cell cell-status   repeat 5</b>
View NxRadio Settings	> <b>show configuration interfaces interface NxRadio nx-config</b>
Monitor NxRadio Status	> <b>show interfaces-state interface NxRadio nx-status   repeat 5</b>
View WiFi Settings	> <b>show configuration interfaces interface Wi-Fi wifi-config</b>



**Table 3-3. CLI Quick Reference Table**

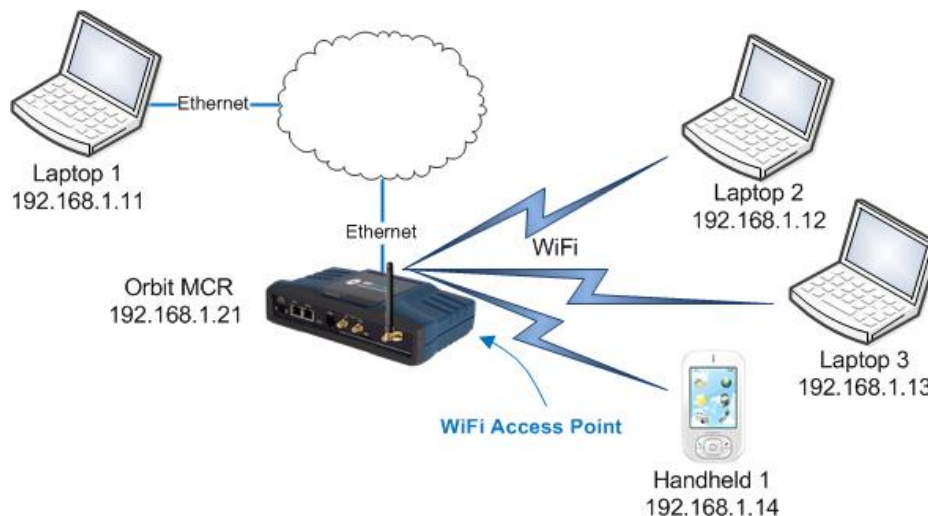
<b>If you wish to...</b>	<b>Enter this CLI command:</b>
Monitor WiFi Status	> <b>show interfaces-state interface Wi-Fi wifi-status   repeat 5</b>
View the routing table	> <b>show routing</b>
View the event log	> <b>show table logging event-log</b>
Set the admin user's password	> <b>request system authentication change-password user admin password admin1234</b>
Set the device name	% <b>set system name "Mydevice"</b>
Set the baud rate on COM1	% <b>set services serial ports COM1 baud-rate b19200</b>
Download a firmware package from TFTP server at 192.168.1.10	> <b>request system firmware reprogram-inactive-image filename mcr-bkrc-4_0_0.mpk manual-file-server { tftp { address 192.168.1.10 } }</b>
Monitor firmware reprogramming status	> <b>show system firmware reprogram-status</b>
Export configuration file to a TFTP server at 192.168.1.10	> <b>request system configuration-files export filename myConfig.xml manual-file-server { tftp { address 192.168.1.10 } }</b>
Reboot device to firmware inactive image	> <b>request system power restart inactive</b>



### 3.4.5 Specific Examples Using CLI

#### Example #1

In Figure 3-17, the Orbit MCR is functioning as a WiFi Access Point to provide connectivity between a set of laptops and a handheld device. The MCR is also acting as a DHCP server for the laptops and handheld device.



**Figure 3-17. Example 1: Unit Providing Laptop and Handheld Device Connectivity**

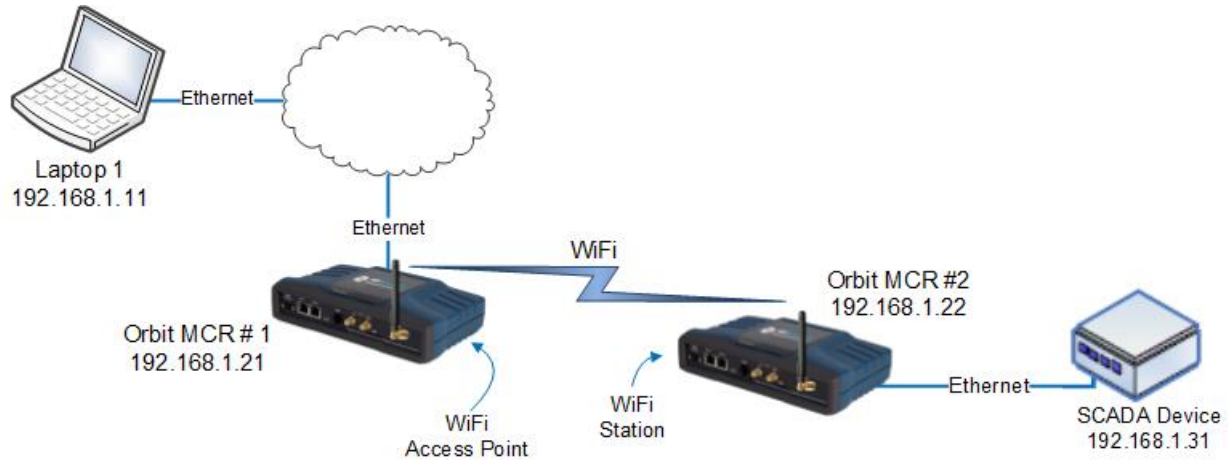
The following commands will configure the MCR for this scenario.

```
% set interfaces interface Wi-Fi type wifi
% set interfaces interface Wi-Fi wifi-config mode access-point ap-config ap myssid enabled true
% set interfaces interface Bridge type bridge
% set interfaces interface Bridge bridge-settings members port ETH1
% set interfaces interface Bridge bridge-settings members wifi-ap myssid
% set interfaces interface Bridge ipv4 address 192.168.1.21 prefix-length 24
% set services dhcp enabled true v4subnet 192.168.1.0/24 domain-name gemds range-start 192.168.1.10 range-end 192.168.1.19 router 192.168.1.1 broadcast-address 192.168.1.255
```



## Example #2

In Figure 3-18, there are two Orbit MCR devices, one acting as a WiFi Access Point, the other as a WiFi Station. Together, the units are providing a wireless bridge between the laptop and the SCADA device.



**Figure 3-18. Example 2: Units Providing Wireless Bridge Between Laptop & SCADA Device**

The following commands will configure the Orbit MCR #1 for this scenario.

```
% set interfaces interface Wi-Fi type wifi
% set interfaces interface Wi-Fi wifi-config mode access-point ap-config ap myssid enabled true
% set interfaces interface Bridge bridge-settings members wifi-ap myssid
% set interfaces interface Bridge ipv4 address 192.168.1.21 prefix-length 24
% set services dhcp enabled true v4subnet 192.168.1.0/24 domain-name gemds range-start 192.168.1.10 range-end 192.168.1.19 router 192.168.1.1 broadcast-address 192.168.1.255
```

The following commands will configure the Orbit MCR #2 for this scenario.

```
% set interfaces interface Wi-Fi type wifi
% set interfaces interface Wi-Fi wifi-config mode access-point ap-config ap myssid enabled true
% set interfaces interface Bridge type bridge
% set interfaces interface Bridge bridge-settings members port ETH1
% set interfaces interface Bridge bridge-settings members wifi-station interface Wi-Fi
% set interfaces interface Bridge ipv4 address 192.168.1.22 prefix-length 24
```

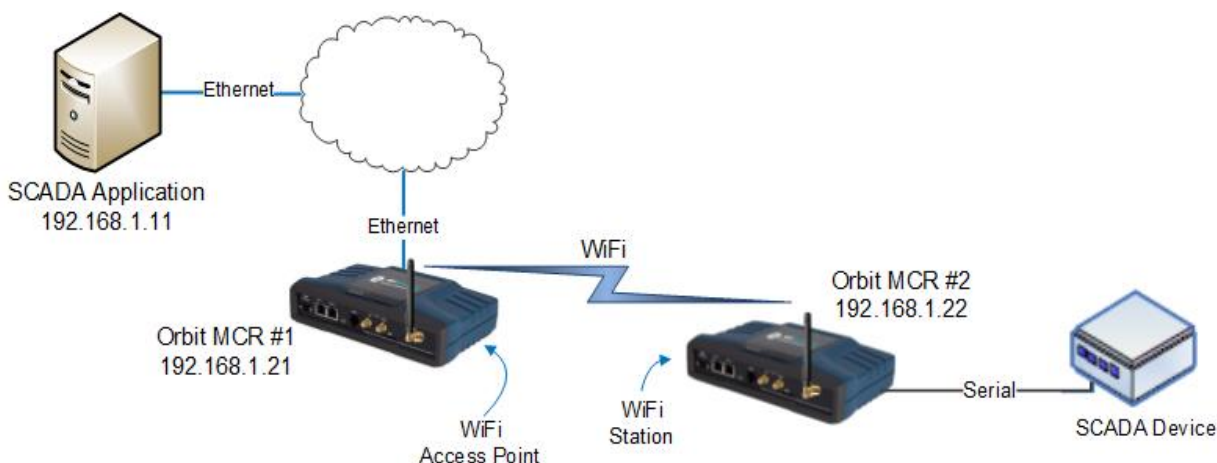




### Example #3

Figure 3-19 shows the Orbit MCR #2 device acting as a terminal server to provide connectivity to the serial-based SCADA device via UDP.

**NOTE** The configuration for Orbit MCR #1 in Figure 3-19, Example 3: Unit Providing Connectivity to Serial-Based SCADA Device via UD is identical to the configuration shown in the previous example (Example #2).



**Figure 3-19. Example 3: Unit Providing Connectivity to Serial-Based SCADA Device via UDP**

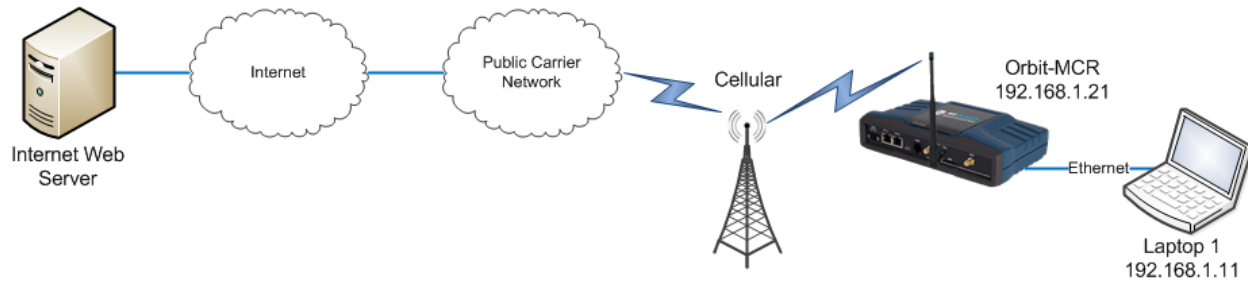
The following commands will configure the Orbit MCR #2 for this scenario.

```
% set interfaces interface Wi-Fi type wifi
% set interfaces interface Wi-Fi wifi-config mode access-point ap-config ap myssid enabled true
% set interfaces interface Bridge type bridge
% set interfaces interface Bridge bridge-settings members port ETH1
% set interfaces interface Bridge bridge-settings members wifi-station interface Wi-Fi
% set interfaces interface Bridge ipv4 address 192.168.1.22 prefix-length 24
% set services serial terminal-server server COM1 mode udp port 30000 remote address 192.168.1.11 port 30001
```



## Example #4

In Figure 3-20, an Orbit MCR provides internet access for a laptop that is accessing a public web page.



**Figure 3-20. Example 4: Unit Providing Internet Access for Laptop**

**SIM Type:** In this scenario, the MCR-4G has a SIM card installed that simply provides Internet access.

The following commands will configure the MCR-4G for this scenario.

```
% set interfaces interface Bridge type bridge
% set interfaces interface Bridge bridge-settings members port ETH1
% set interfaces interface Bridge ipv4 address 192.168.1.1 prefix-length 24
% set services firewall enabled true
% set services firewall address-set LOCAL-NETS addresses [192.168.1.0/24]
% set services firewall filter IN_UNTRUSTED rule 1 match protocol icmp
% set services firewall filter IN_UNTRUSTED rule 1 actions action accept
% set services firewall filter IN_UNTRUSTED rule 10 match protocol all
% set services firewall filter IN_UNTRUSTED rule 10 actions action drop
% set services firewall filter OUT_UNTRUSTED rule 1 match src-address address-set LOCAL-NETS
% set services firewall filter OUT_UNTRUSTED rule 1 match src-address add-interface-address true
% set services firewall filter OUT_UNTRUSTED rule 1 actions action accept
% set services firewall filter OUT_UNTRUSTED rule 10 match protocol all
% set services firewall filter OUT_UNTRUSTED rule 10 actions action drop
% set services firewall nat source rule-set MASQ
% set services firewall nat source rule-set MASQ rule 1 source-nat interface
% set interfaces interface Cell type cell enabled true
% set interfaces interface Cell filter input IN_UNTRUSTED
% set interfaces interface Cell filter output OUT_UNTRUSTED
% set interfaces interface Cell nat source MASQ
```



The following sections describe key operational features of the MCR unit and list configuration options for them. Each major heading begins at the top of a new page. For this reason, large areas of white space exist at the end of some sections. This is done to provide a clear delineation between major sections.

---

**NOTE** The LAN port should be assigned IP addresses only if it is a routed interface (that is, *not* in a bridge).

---

---

**NOTE** The commands that follow in this section vary depending on the Orbit MCR options ordered.

---

## 3.5 Interface Configuration

### 3.5.1 Serial Interface

A serial cable (RJ45 cable with proper ETH to DB9 converter) may be used to connect to a COM port on the unit to access the CLI. The default serial console settings are 115200 bps with 8N1 format. A mini-USB-to-USB cable may also be used to connect to a Computer in case no serial port exists. If a mini-USB connection is used, the computer must contain the appropriate device driver. A driver for serial operation can be found on GE MDS website.

### Configuring

The screens below shows console access to the COM1 serial and USB port:

Navigate to: *Serial ---> Basic Config / Ports*

Serial Service

Status Basic Config Advanced Config Actions

Ports

Search

Name	Line Mode	Baud Rate	Byte Format	Hw Flow Control	Hw Device Mode	Cts Delay
COM1	rs232	b115200	bf8n1	false	DCE	0
USB1	rs232	b115200	bf8n1	false	DCE	0

Showing 1 to 2 of 2

Click on **COM1** to get:

Configure Ports Details

- Line Mode: Rs 232
- Baud Rate: B 115200
- Byte Format: Bf 8n 1
- Hw Flow Control:
- Vmin: 255
- Vtime: 100
- Capability:
  - Rs 485 2 Wire
  - Rs 485 4 Wire

Finish

Figure 3-21. COM1 Configuration Screen



- **Line Mode** - Selection of the operation line mode of the serial port. Choices are:
  - RS232 (DEFAULT)
  - RS485 - 2 Wire
  - RS485 - 4 Wire
- **Baud Rate** - The serial port baud rate in bps. Choices are 1200, 2400, 4800, 9600, 19200, 38400, 57600, 115200 (DEFAULT), 230400.
- **Byte Format** - The data byte format in bits, parity and stop bits: Choices are:
  - 7N1 - 7 char bits, no parity, 1 stop bit
  - 7E1 - 7 char bits, even parity, 1 stop bit
  - 7O1 - 7 char bits, odd parity, 1 stop bit
  - 7N2 - 7 char bits, no parity, 2 stop bits
  - 7E2 - 7 char bits, even parity, 2 stop bits
  - 7O2 - 7 char bits, odd parity, 2 stop bits
  - 8N1 - 8 char bits, no parity, 1 stop bit (DEFAULT)
  - 8E1 - 8 char bits, even parity, 1 stop bit
  - 8O1 - 8 char bits, odd parity, 1 stop bit
  - 8N2 - 8 char bits, no parity, 2 stop bits
  - 8E2 - 8 char bits, even parity, 2 stop bits
  - 8O2 - 8 char bits, odd parity, 2 stop bits
- **Hw Flow Control** - Hardware flow control enable/disable (DEFAULT) using RTS/CTS lines
- **Vmin** - Receive Buffer Size - The minimum number of data bytes that will be buffered by the serial port before handling of the data to be processed by the terminal server. (255 = DEFAULT).
- **Vtime** - Receive Inter-Byte Timeout - The amount of time between bytes of data on the serial port (**in multiples of 1 millisecond**), that indicate the end of a serial message ready to be processed by the terminal server. (100 = DEFAULT)
- **Capability** – Describes the capabilities of the serial port. (Read Only) For example, in the above figure the COM1 port is capable of operating in RS232 or RS485 mode.
  - Rs 485 2 Wire
  - Rs 485 4 Wire

Click on the USB1 to get:

**Configure Ports Details**

- Line Mode: Rs 232
- Baud Rate: B 115200
- Byte Format: Bf 8n 1
- Hw Flow Control:
- Vmin: 255
- Vtime: 100
- Capability:

Finish



- **Line Mode** - Selection of the operation line mode of the serial port. Choices are:
  - RS232 (DEFAULT)
  - RS485 - 2 Wire
  - RS485 - 4 Wire
- **Baud Rate** - The serial port baud rate in bps. Choices 1200, 2400, 4800, 9600, 19200, 38400, 57600, 115200 (DEFAULT), 230400.
- **Byte Format** - The data byte format in bits, parity and stop bits: Choices are:
  - 7N1 - 7 char bits, no parity, 1 stop bit
  - 7E1 - 7 char bits, even parity, 1 stop bit
  - 7O1 - 7 char bits, odd parity, 1 stop bit
  - 7N2 - 7 char bits, no parity, 2 stop bits
  - 7E2 - 7 char bits, even parity, 2 stop bits
  - 7O2 - 7 char bits, odd parity, 2 stop bits
  - 8N1 - 8 char bits, no parity, 1 stop bit (DEFAULT)
  - 8E1 - 8 char bits, even parity, 1 stop bit
  - 8O1 - 8 char bits, odd parity, 1 stop bit
  - 8N2 - 8 char bits, no parity, 2 stop bits
  - 8E2 - 8 char bits, even parity, 2 stop bits
  - 8O2 - 8 char bits, odd parity, 2 stop bits
- **Hw Flow Control** - Hardware flow control enable/disable (DEFAULT) using RTS/CTS lines
- **Vmin** - Receive Buffer Size - The minimum number of data bytes that will be buffered by the serial port before handling of the data to be processed by the terminal server. (255 = DEFAULT).
- **Vtime** - Receive Inter-Byte Timeout - The amount of time between bytes of data on the serial port (**in multiples of 1 millisecond**), that indicate the end of a serial message ready to be processed by the terminal server. (100 = DEFAULT)

From the CLI, this sequence shows how to add console access to the COM1 and COM2 serial ports and set the COM2 baud rate to 19200 bps:

```
% set services serial console serial-ports [COM1 COM2]
% set services serial ports COM2 baud-rate b19200
% commit
```

## Terminal Server Settings

When configuring a serial port that will be used as a terminal server the VMIN and VTIME settings need additional explanation. As described above VMIN is a number describing bytes that are received from the interface, while VTIME is in 100<sup>th</sup>s of a second (100 milliseconds) intervals. They act together to control serial data collection and transmission as described below:

- VMIN == 0; VTIME == 0: The terminal server will continuously read to see if a byte if data is available and process each byte.

---

**NOTE** While this is a valid mode in most cases this causes a high processing load on the device that may impact performance of other operations of the device.

---

- VMIN > 0; VTIME == 0: The terminal server waits to process data until at least VMIN bytes of serial data are received.



- VMIN == 0; VTIME > 0: If serial data is received, the terminal server will continuously read the number of bytes available until VTIME has elapsed then process the data.
- VMIN > 0; VTIME > 0: Once an initial byte of input becomes available the terminal server waits until the MIN bytes have been read, or when the inter-byte timeout expires. The timer is restarted after each further byte is received and because the timer is started only after the initial byte is received, at least one byte will be read.

## Serial Hardware Flow Control

Hardware Flow Control: When operating in CTSKEY mode, all serial ports in the data path are required to be set to the same baud rate, and that VMIN and VTIME remain at the defaults for serial data packets less than or equal to 255 bytes. For serial packets over 255 bytes it is recommended that a cts-delay time of at least 90ms be used to account for the VTIME delay of the over-the-air sending unit.

### Hardware Flow Control Modes:

1. DCE
  - CTS follows RTS after a programmable **CTS delay**.
  - If the unit's input buffer approaches a full condition it can deassert CTS regardless of state of RTS.
2. CTSKEY
  - Based on legacy MDS devices including TransNET, the device will act similar to a DTE but will provide signaling on the CTS line instead of the RTS line.
  - When the first character of a transmission is ready to be sent to the serial port, the unit shall assert CTS and delay for **CTS delay** time expiration before outputting the first character.
  - After the last character of a transmission is output from the serial port, the unit shall keep CTS asserted until the expiration of **CTS hold** time.
3. CTSKEYPLUS
  - The unit shall support flow control (Throttling) on the RTS pin. The device is expected to be wired via null modem to an external DCE device. The CTS line of the external DCE device drives the RTS line of the unit.

### Outlined Configuration: Orbit MCR: Hardware Flow Control

1. Configure Serial Port under test for Hardware Flow Control
  - Configure Hw Flow Control to true
  - Configure Hw Device Mode: DCE, CTSKEY, CTSKEYPLUS
  - Configure any remaining parameters, Cts Delay, Cts Hold, VMIN, VTIME
2. Save/Commit Configuration

### Step by step Web based Walkthrough:

1. On the left hand side of the Web GUI, click *Services*.
2. Click *Serial* from the Services drop down.
3. Click the Serial Port *Name* on the **Basic Config** tab to configure Hardware Flow Control.

---

**NOTE** **Cts Hold** -The CTS hold parameter is applicable only when h/w device mode = CTSKEY or CTSKEYPLUS. This parameters specifies the time (in milliseconds) to hold CTS up after data is transmitted.

---



Name	Line Mode	Baud Rate	Byte Format	Hw Flow Control	Hw Device Mode	Cts Delay
COM1	rs232	b115200	bf8n1	false	DCE	0
USB1	rs232	b115200	bf8n1	false	DCE	0

Showing 1 to 2 of 2

1. To enable Hardware Flow Control, click the *Hw Flow Control* checkbox.
2. Adjust the new parameters to fit the system, *Hw Device Mode*, *Cts Delay*, *Cts Hold*.

### Configure Ports Details

- Line Mode: Rs 232
- Baud Rate: B 115200
- Byte Format: Bf 8n 1
- Hw Flow Control:
- Hw Device Mode: DCE
- Cts Delay: 0
- Vmin: 255
- Vtime: 100
- Capability:
  - Rs 485 2 Wire
  - Rs 485 4 Wire

Finish

3. This is also where VMIN and VTIME can be adjusted.
4. Save the Configuration.

## CLI Configuration Commands

Change *ITALICS* to fit the system

### Configure the following as an example:

```
% set services serial ports COM1 hw-flow-control true hw-device-mode CTSKEY cts-delay 90
cts-hold 40
% commit
```

## Monitoring

From the Web UI, the Serial Ports screen shows the settings:

Navigate to: *Serial ---> Basic Config / Ports*



## Serial Service

Status Basic Config Advanced Config Actions

Ports

Search

Name	Line Mode	Baud Rate	Byte Format	Hw Flow Control	Hw Device Mode	Vmin	Vtime
COM1	rs232	b115200	bf8n1	true	DCE	255	100
USB1	rs232	b115200	bf8n1	false	DCE	255	100

Showing 1 to 2 of 2

**NOTE** Vmin and Vtime are not displayed by default. To modify the view, click the button and add them to the view.

From the CLI in operational mode, follow the example below to view the state and statistics:

```
> show configuration services serial | details
ports COM1 {
    line-mode          rs232;
    baud-rate          b115200;
    byte-format        bf8n1;
    hw-flow-control    false;
    vmin               255;
    vtime               1;
    capability          rs485-2-wire,rs485-4-wire;
}

ports COM2 {
    line-mode          rs232;
    baud-rate          b19200;
    byte-format        bf8n1;
    hw-flow-control    false;
    vmin               255;
    vtime               1;
    capability          "";
}

console {
    serial-ports [ COM1 COM2 ];
}
```

### 3.5.2 Cell

#### Understanding

Orbit MCR product family is available with following cellular modem options:

- Verizon Wireless 4G LTE modem
- 3G GSM/UMTS/HSPA+ modem
- 4G LTE GSM (EMEA/APAC)
- 4G LTE GSM (North America)





**NOTE** GE MDS is continually certifying the product for different countries and carriers, please contact GE MDS sales or technical support to inquire about the current certification status for particular country/carrier.

Orbit MCR supports routing of TCP/UDP/IP data from the Cellular WAN network interface to any of the other network interfaces (including WiFi or LAN) using the IPsec VPN or network address and port translation (NAPT) feature and to the COM1 (or COM2) serial port using the terminal server service. The configuration of these use cases is specified in the respective sections on VPN, Firewall and NAT and Terminal Service.

The cellular modem inside the unit supports main (primary) and secondary antenna (for receive diversity). The primary antenna must be installed for the cell modem to register with the cellular network. It is strongly recommended that a secondary antenna be installed for achieving a robust cellular link. There should be no physical obstructions around the antennas. The main and diversity antennas must have at least 27 dB of isolation from each other to ensure optimal operation of the cellular modem. For Antenna Installation assistance, see “Antenna Planning and Installation” on Page 31 or contact your local GE MDS representative. See the below table for approved Antenna Types.

**Table 3-4. Approved Cell Antenna Types**

Application	Location	Frequency Range	Gain	Antenna Description	GE MDS Part Number
3G/4G Cellular	Indoor	698-2700MHz CELL BANDS	2 dBi	Direct Connect, - SMA Paddle antenna	97-2485A04
3G/4G Cellular	Outdoor	698-2700MHz CELL BANDS	4.5 dBi	External Mount, Omni Ant. with N-Female connector - no cable Note: requires a metal Ground Plane	97-2485A05
3G/4G Cellular	Outdoor	698-2700MHz CELL BANDS	1 dBi	External Mount, Dipole Omni with N-Female connector - no cable	97-2485A06

Table 3-5 describes the Orbit MCR’s LED behavior when using the cellular interface.

**Table 3-5. Cell Interface LED Descriptions**

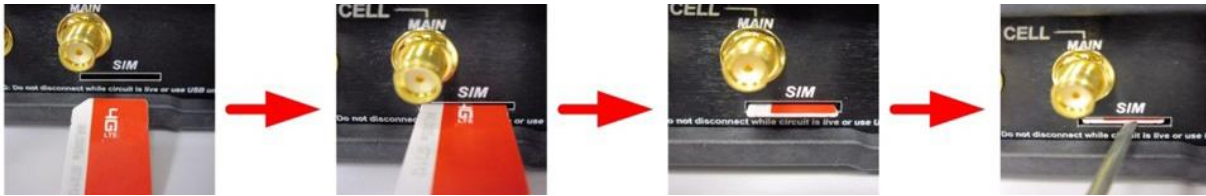
LED - NIC1	State	Description
Cell Interface	Off	No cellular connection
	Solid green	Cell connection

**SIM Port(s)** - These ports accept a mini SIM card (2FF type) for cell operation. The unit’s cellular interface will not function without a valid SIM card installed. Users are responsible for obtaining a provisioned SIM card for the appropriate service plan from their cellular provider. Information on determining the cell module’s IMSI/IMEI (typically required for provisioning) is provided on Page 75 of this manual.



**CAUTION:** Do not insert the SIM card when the unit is powered on.

**Card Insertion:** The SIM card only inserts one way; do not force it. It should be inserted with the printed label facing up and the cut-off corner on the left side (see figure below). A small instrument, such as a flathead screwdriver, may be helpful to *gently* push the SIM all the way in until it locks.



**Figure 3-22. Steps for Inserting the SIM Card**

**NOTE** The insertion example above shows the default SIM slot (Slot A). Units equipped with multiple SIM ports will label the upper slot SIM B and the lower slot SIM A.

**NOTE** Dual SIM functionality is a selective order-entry feature. Default units are shipped with only SIM-A enabled; SIM-B is not supported.

## Configuring

A **Connection Profile** must be configured for the unit to establish a data connection with the cellular network. A connection profile allows the user to configure various parameters related to the cellular connection. One or more connection profiles can be configured on the unit. The order of the connection profiles can be chosen by the user. The unit will use the first connection profile to establish connection with the cellular network. If connection profile switching (described later) is enabled, then the unit will switch to second profile in the list if it is unable to establish a connection using the first profile after a configurable, specified timeout.

An Orbit MCR equipped with a Verizon 4G LTE modem is shipped out of the factory with the cellular interface enabled and a connection profile (named **PROFILE-1**) configured to connect with Verizon's Internet Packet Data Network (PDN).

An Orbit MCR equipped with a 3G GSM modem is shipped out of the factory with the cellular interface disabled. The user will need to create a connection profile with the cellular network specific parameters prior to enabling the interface to allow unit to connect to the network.

In the UI, start on the following page: *Interfaces / Cell ---> Basic Config / Cellular*

**Cell Interface**

Status Basic Config **Advanced Config** Actions

General  
Cellular

Cell Config

**Connection Profile**

Search  Add ... Delete Move ▾

Name	Network Config - Technology Selection	Network Config - Service Domain	Bearer Config - Apn	Bearer Config - Protocol	Bearer Config - Auth Type	Bearer Config - Username
Table is empty						

**Connection Profile Switching**

- Switch to Next on Roaming
- Switch to Next on Failure
- Switch to Next on Failure Timeout
- Switch to First on Timeout
- Switch to First Timeout

**Figure 3-23. Connection and Connection Profile Switching UI Screen**



The cellular configuration is configured by creating a “Connection Profile” to describe the connection and consists of four major groups of information:

- **Network Configuration** - contains various parameters related to how the modem registers with the cellular network.
- **Bearer Configuration** - parameters related to data connection with the cellular network.
- **Keep Alive** - Keep alive configuration for sending ICMP Echo messages to a remote host/server periodically to keep the connection alive
- **Service Recovery** - Service recovery configuration

If multiple cellular providers are supported, the “Connection Profile Switching” choices may need to be configured.

The following is an example UI screen to create a connection profile named **ORBIT1** by clicking on the **ADD** button and naming the profile as such.

**Configure Connection Profile Details**

Name\*

---

**Configure Connection Profile Details**

**Network Config**

Technology Selection

Service Domain

**Bearer Config**

Apn

Protocol

Auth Type

Mtu

Request Dns

Request Routers

Keep Alive

**Service Recovery**

General Recovery Interval

Lte Recovery

Lte Recovery Interval

**Figure 3-24. Example Connection Profile**

Each **Connection Profile** has grouped information that contains specific information to be selected. The choices are described below:

- **Network Configuration** - contains various parameters related to how the modem registers with the cellular network.



- **Technology-selection** - The user can configure the modem to automatically select the network technology to connect to (automatic) or force it to register only on:
  - Automatic (DEFAULT)
  - 2G GSM (geran),
  - 3G UMTS (utran),
  - 4G LTE (e-utran),
  - 2G CDMA(cdma-1xrtt)
  - 3G CDMA EV-DO (cdma-evdo).
- **Service Domain** - Network Service Domain - choices are:
  - Circuit Switched (CS) and Packet Switched (PS)
  - Packet Switched (PS) Only

If cellular network does not support CS then configure as PS Only. Consult your service provider for this information. Typically, this field is left as default.

- **Bearer Configuration** - parameters related to data connection with the cellular network.
  - **Apn** - Once the unit has registered to the cellular network, it sets up the IP data connection with a specific Packet Data Network (PDN) identified by the Access Point Name (APN). APN is a string identifier. An Orbit MCR equipped with a Verizon 4G LTE modem comes preconfigured with an APN of **vzwinternet**. Hence, it attempts to set up a data connection towards Verizon's internet PDN that provides internet connectivity. For this data connection to succeed, a SIM card that has been provisioned for internet access needs to be obtained from the Verizon Wireless and installed in the unit. See “ APPENDIX E – Obtaining Provisioned 4G/LTE Service (Verizon)” on Page 417. If a private network (PN) account has been set up with Verizon wireless, a SIM card will be issued from that account. When the modem is powered up with such a SIM, the default APN on the modem is automatically updated to the one that identifies the user’s private network. This procedure is called OTA APN update. This procedure might not always succeed and hence, may require the user to manually update the APN on the MCR.

The following example shows how to update the APN to, **MYAPN.GW6.VZWENTP**, manually, via the CLI:

```
% set interfaces interface Cell cell-config connection-profile PROFILE-1 bearer-config
apn MYAPN.GW6.VZWENTP
% commit
```

An Orbit MCR equipped with a 3G GSM modem is shipped out of factory with cellular interface disabled. The following example shows how to create a connection profile to allow it to connect to, for example, AT&T's 3G GSM network with an APN entitled "Broadband":

```
% set interfaces interface Cell cell-config connection-profile AT&T bearer-config apn
Broadband
% set interfaces interface Cell enable true
% commit
```

- **Protocol** - This parameter specifies the Packet Data Protocol (PDP) type. DEFAULT - “IP”.

---

**NOTE** The user should leave this parameter to the default value of IPv4 - IPv6 functionality is not currently supported.

---

- **Auth-type, Username, Password** - These parameters should be set if the cellular network provider requires a username and a password along with authentication protocol (PAP, CHAP or PAP/CHAP) to be specified. The user does not need to configure the MCR with 4G LTE modem with these parameters. The user may need to configure MCR with 3G GSM modem parameters, depending on the cellular network.



- **Mtu** - Maximum Transmission Unit in bytes - leave at the default value of 1500, unless directed by technical support to change.
- **Request DNS** – If enabled, the DNS servers used by the system are obtained by the DHCP client running on this interface.
- **Request Routers** - If enabled, default route used by the system is obtained by the DHCP client running on this interface.

---

**NOTE** If multiple interfaces are configured to obtain addresses using DHCP, only, one of the interfaces should enable request-dns and request-routers parameters.

---

- **Keep Alive** - The keep-alive feature allows the cellular modem to maintain connection in situations where no traffic is passed over the cellular link for long periods of time or when the traffic is traversing through a NAT middle box in the network and where the mobile terminated traffic can be sent only if the NAT entries exist for corresponding mobile originated traffic. The keep-alive mechanism sends an ICMP echo message to the configured address/name at the configured interval. This feature should be used only if an application is passing data very infrequently over a cellular connection (i.e., if data is passed at a rate of less than once per hour).
  - **Address** - This parameter specifies the address or DNS name of the destination host to which keep-alive messages should be sent
  - **Interval** - This parameter specifies the time interval (in minutes) between keep-alive messages
  - **Recovery on Timeout** - This parameter enables the connectivity recovery mechanism to reset the cellular modem if no response to the keep-alive messages are received up to max-num-retries attempts. DEFAULT - *true* if the keep-alive feature is configured
  - **Max Num Retries** - This parameter specifies the number of keep-alive messages that are sent before modem recovery is attempted. DEFAULT - *15* - configurable only when recovery-on-timeout is enabled.
- **Service Recovery** - The service recovery configuration block contains various parameters related to service recovery feature. The service recovery mechanism is meant as a watchdog mechanism for the cellular connection, where the cellular modem is reset by the following conditions:
  - The unit is unable to register at all on the network.
  - The unit is unable to register specifically to the LTE service.
  - **General Recovery Interval** - This parameter specifies the time interval after which the cellular modem is reset if the modem-state does not transition out of the 'unknown' state. DEFAULT - **300 sec** (5 min).
  - **Lte Recovery** – For an Orbit MCR equipped with an LTE modem, this parameter enables LTE service recovery. The LTE service recovery mechanism resets the cellular modem if it is stuck in 3G service-state (EV-DO or UMTS) for more than the lte-recovery-interval. This is enabled by default. This parameter affects only units with LTE capable modem.
  - **Lte Recovery Interval** - For an Orbit MCR with an LTE modem, this parameter specifies the time interval (in sec) after which, the cellular modem is reset if the modem-state does not transition to 'LTE' service-state. DEFAULT - **900 sec** (15 min).
    - `% set interfaces interface Cell cell-config service-recovery lte-recovery false`
    - `% commit`

---

**NOTE** The **Lte Recovery** mechanism should be disabled if the unit is deployed in areas that either lack or have poor LTE coverage. Otherwise, the cellular modem and hence the cellular data connection will be unnecessarily reset every '**lte-recovery-interval**' seconds.

---

- **sim-slot** - This parameter specifies the SIM slot that should be used to read the SIM card. Orbit MCR units equipped with cell may have one or two SIM slots: SIM-A and SIM-B. DEFAULT - SIM-A. The slots are located on the outside of the case, on the front panel. If



multiple slots are provided, the upper slot will be labeled SIM-B and the lower slot will be labeled SIM-A.

---

**NOTE** The **sim-slot** option will not be visible unless Dual SIM functionality is installed in the factory as part of the selective order-entry feature, for the 3G module. By default units are shipped with only SIM-A enabled; SIM-B is not supported.

---

In addition to the **Connection Profile** configuration, the **Connection Profile Switching** feature allows a user to enable switching when one or more profiles are configured on a unit. This feature can be used to implement dual SIM functionality, where the user obtains and configures a unit with two SIM cards, each from a different cellular provider. This can help increase the reliability of the connection by allowing the unit to switch to a different SIM card if data connection with the other SIM card fails for any reason (for example, due to reduced signal strength and so on).

For example, the UI screen for a **Connection Profile Switching** is shown below:

*Interfaces / Cell ---> Basic Config / Cellular*



**Figure 3-25. Connection Profile Switching Example**

- **Switch to Next on Roaming** - This parameter enables connection profile switching when the roaming-state of current connection changes to roaming. DEFAULT - **FALSE** (disabled).
- **Switch to Next on Failure** - This parameter enables connection profile switching when data connection failure occurs when using the current profile. DEFAULT - **FALSE** (disabled).
- **Switch to Next on Failure Timeout** - This parameter specifies the time interval for which data connection is attempted using the current connection profile before switching to next one in the list. DEFAULT - **30** min.
- **Switch to First on Timeout** - This parameter enables switching of connection profile to the first one in the list irrespective of current connection status. DEFAULT - **FALSE** (disabled).
- **Switch to First Timeout** - This parameter specifies the time interval after which data connection is attempted using the first profile in the list regardless of current connection status. DEFAULT - **60** min.

---

**NOTE** The cellular provider network can disconnect the cellular connection if any packets get routed from LAN to Cellular interface without undergoing masquerading (Source Network Address Translation (NAT) before exiting the cellular interface. Therefore, always configure masquerading on the cellular interface. See “Source NAT (Masquerading)” on Page 226 for more information on NAT configuration.

---

Use of the “**Connection Profile Switching**” feature requires the user to configure two profiles; each with specific cellular provider information for the respective SIM slot. For example, say the SIM card from carrier A is inserted in SIM-A and the SIM card from carrier B is inserted in SIM-B.

- Configure a profile for carrier A to use SIM-A:

```
% set interfaces interface Cell cell-config connection-profile CARRIER_A bearer-config apn carrierA.apn
% set interfaces interface Cell cell-config connection-profile CARRIER_A sim-slot SIM-A
```
- Configure a profile for carrier B to use SIM-B:



```
% set interfaces interface Cell cell-config connection-profile CARRIER_B bearer-config apn carrierB.apn
```

```
% set interfaces interface Cell cell-config connection-profile CARRIER_B sim-slot SIM-B
```

- Enable connection profile switching on connection failure

```
% set interfaces interface Cell cell-config switch-to-next-on-failure true
```

- Enable cell and commit configuration

```
% set interfaces interface Cell enable true
```

```
% commit
```

---

**NOTE** Dual SIM functionality is a selective order-entry feature. Default units are shipped with only SIM-A enabled; SIM-B is not supported.

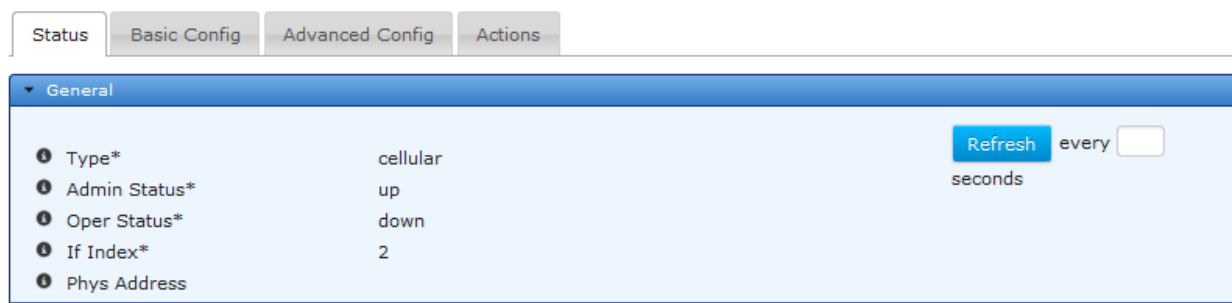
---

## Monitoring

From the Web UI, status of the cell module can be reviewed on the page:

*Interfaces / Cell ---> Status / General*

### Cell Interface



Property	Value
Type*	cellular
Admin Status*	up
Oper Status*	down
If Index*	2
Phys Address	

**Figure 3-26. Cell Interface Status Screen**

- **Type** - The type of the interface
- **Admin Status** - The desired state of the interface.
- **Oper Status** - The current operational state of the interface.
- **If Index** - The if Index value for the if Entry represented by this interface. Valid values: 1—2147483647
- **Phys Address** - The interface's address at its protocol sub-layer. For example, for an 802.x interface, this object normally contains a MAC address.

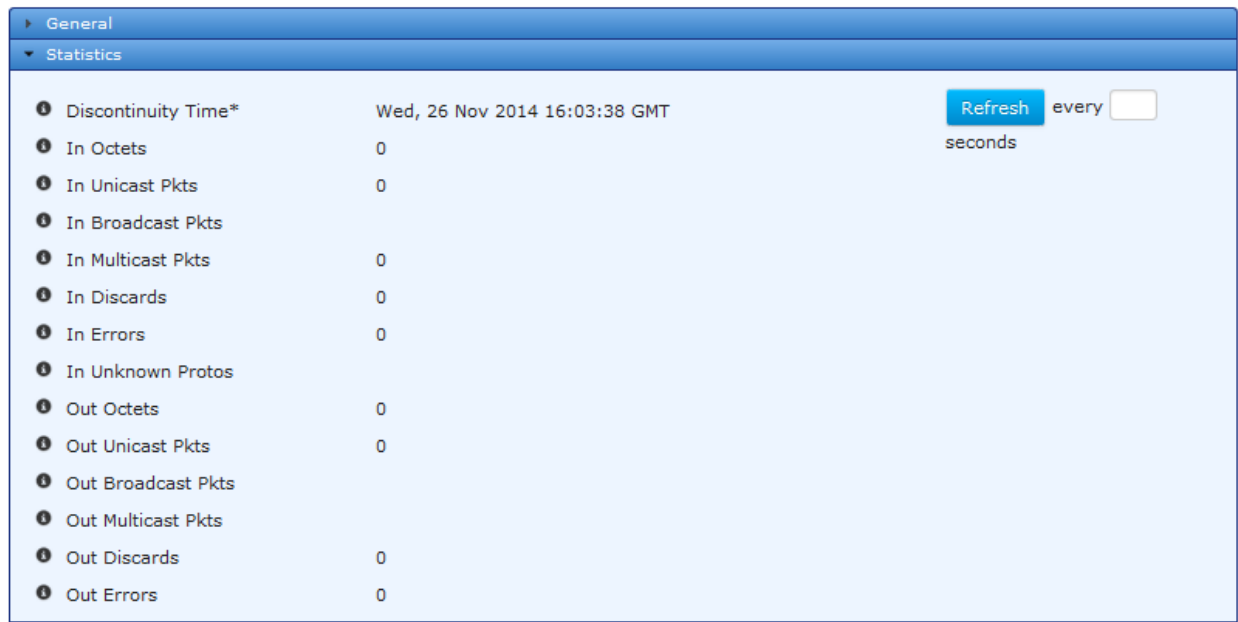


Figure 3-27. Cell Interface Statistics Screen

- **Discontinuity Time** - The time on the most recent occasion at which any one or more of this interface's counters suffered a discontinuity or interruption of service.
- **In Octets** - The total number of octets received on the interface, including framing characters.
- **In Unicast Pkts** - The number of packets, delivered by this sub-layer to a higher (sub-)layer, which were not addressed to a multicast or broadcast address at this sub-layer.
- **In Broadcast Pkts** - The number of packets, delivered by this sub-layer to a higher (sub-)layer, which were addressed to a broadcast address at this sub-layer.
- **In Multicast Pkts** - The number of packets, delivered by this sub-layer to a higher (sub-)layer, which were addressed to a multicast address at this sub-layer.
- **In Discards** - The number of inbound packets which were chosen to be discarded even though no errors had been detected to prevent their being deliverable to a higher-layer protocol. One possible reason for discarding such a packet could be to free up buffer space.
- **In Errors** - For packet-oriented interfaces, the number of inbound packets that contained errors preventing them from being deliverable to a higher-layer protocol.
- **In Unknown Protos** - For packet-oriented interfaces, the number of packets received via the interface which were discarded because of an unknown or unsupported protocol.
- **Out Octets** - The total number of octets transmitted out of the interface, including framing characters.
- **Out Unicast Pkts** - The total number of packets that higher-level protocols requested be transmitted, and which were not addressed to a multicast or broadcast address at this sub-layer, including those that were discarded or not sent.
- **Out Broadcast Pkts** - The total number of packets that higher-level protocols requested be transmitted, and which were addressed to a broadcast address at this sub-layer, including those that were discarded or not sent.
- **Out Multicast Pkts** - The total number of packets that higher-level protocols requested be transmitted, and which were addressed to a multicast address at this sub-layer, including those that were discarded or not sent.
- **Out Discards** - The number of outbound packets which were chosen to be discarded even though no errors had been detected to prevent their being transmitted.



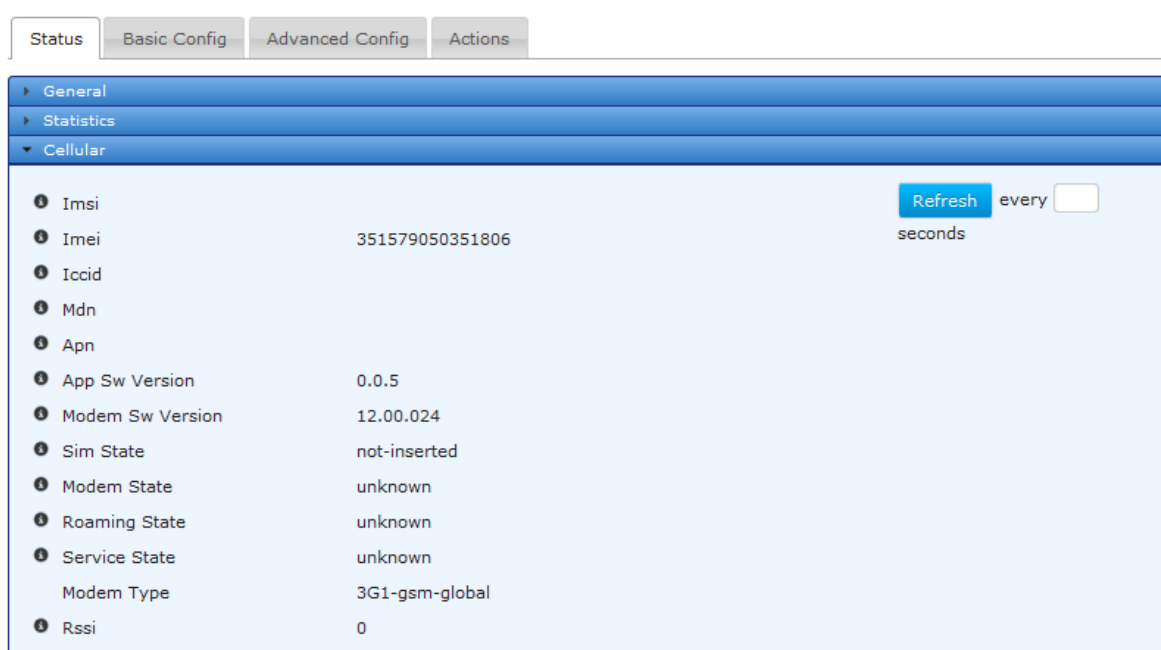


- **Out Errors** - For packet-oriented interfaces, the number of outbound packets that could not be transmitted because of errors.

### 3.5.2.1 Cell Status (Including the Module's IMSI/IMEI)

When provisioning the cell module for network service, the cellular provider typically requires the International Mobile Subscriber Identity code (IMSI) or International Mobile Station Equipment Identity code (IMEI) to be provided. The Cell Status page contains this information.

Navigate to **Interfaces / Cell ---> Status / Cellular**



**Figure 3-28. Cell Operational Status Screen**

- **Imsi** - International mobile subscriber identity
- **Imei** - International mobile equipment identity
- **Iccid** - Unique serial number of the SIM card
- **Mdn** - Mobile directory number.
- **Apn** - Access Point Name
- **App Sw Version** - Application software version.
- **Modem Sw Version** - Modem software version
- **Sim State** - SIM state - (Inserted, Not Inserted)
- **Modem State** - Device state of the cellular modem
- **Roaming State** - Roaming state of the cellular modem
- **Service State** - Service state of the cellular modem
- **Modem Type** - This parameter identifies the type of modem inside the unit.
- **Rssi** - Received signal strength indicator (dBm) of cellular modem.

### Monitoring via the CLI

Ensure the CLI is in Operational mode.



## Check cell status

The example on the following page shows cell status of a unit with 3G GSM modem operating on AT&T network:

```
> show interfaces-state interface Cell cell-status
cell-status imsi 310410635138718
cell-status imei 351579050793072
cell-status iccid 89014103276351387185
cell-status mdn 15857544129
cell-status apn ccspbsc210.acfes.org
cell-status app-sw-version 0.0.5
cell-status modem-sw-version 12.00.024
cell-status sim-state ready
cell-status modem-state connected
cell-status roaming-state home
cell-status service-state hsdpa
cell-status rssi -71
```

The example below shows cell status of a unit with Verizon Wireless 4G LTE modem operating:

```
> show interfaces-state interface Cell cell-status
cell-status imsi 311480023786469
cell-status imei 990000947614196
cell-status iccid 89148000000234127091
cell-status mdn 5854724645
cell-status apn VZWINTERNET
cell-status app-sw-version 0.0.5
cell-status modem-sw-version "4.08.02 SVN 0 [2012-12-21 10:52:58]"
cell-status sim-state ready
cell-status modem-state connected
cell-status roaming-state home
cell-status service-state lte
cell-status rssi -52
```

## Check Cell Statistics

```
> show interfaces-state interface Cell statistics
statistics discontinuity-time 2013-01-01T02:16:01+00:00
statistics in-octets 1218
statistics in-unicast-pkts 18
statistics in-multicast-pkts 0
statistics in-discards 0
statistics in-errors 0
statistics out-octets 774
statistics out-unicast-pkts 14
statistics out-discards 0
statistics out-errors 0
```



## Check Cell IP Address

```
> show interfaces-state interface Cell ipv4
  ipv4 forwarding true
  ipv4 mtu 1500
```

IP	PREFIX LENGTH	ORIGIN
166.130.200.173	32	static

IP	LINK LAYER ADDRESS	ORIGIN	STATE
0.0.0.0	19:00:00:00:d0:60	dynamic	reachable

## Determining the Cell Module's IMSI/IMEI

When provisioning the cell module for network service, the cellular provider typically requires the International Mobile Subscriber Identity code (IMSI) or International Mobile Station Equipment Identity code (IMEI) to be provided. These codes can be determined by entering the following command:

```
> show interfaces-state interface Cell cell-status
```

where *Cell* is the configured name for the cellular device. Cell is the factory default name, but it may have been changed by a previous user.

When the previous command is entered, a number of items are returned as shown in the example below. The first two items (highlighted blue) show the IMSI and IMEI codes. These are unique for each unit.

```
cell-status imsi 311480023631413
cell-status imei 990000947608727
cell-status iccid 89148000000232694605
cell-status mdn 5857948168
cell-status apn VZWINTERNET
cell-status app-sw-version 0.0.5
cell-status modem-sw-version "4.08.02 SVN 0 [2012-12-21 10:52:58]"
cell-status sim-state Ready
cell-status modem-state connected
cell-status roaming-state home
cell-status service-state lte
cell-status rssi -62
```

### 3.5.2.2 Cell Modem Reprogramming

#### Understanding

The cell modem has its own set of firmware supplied by the wireless carrier. Occasionally new versions of this firmware become available. The user has the option to upgrade the cell modem firmware if they wish to do so.

GE posts new cell firmware at:

[http://www.gegridsolutions.com/communications/mds/software.asp?directory=Orbit\\_MCR/Cell](http://www.gegridsolutions.com/communications/mds/software.asp?directory=Orbit_MCR/Cell)



Firmware compatible with North American MCR/ECR 4G LTE modules with FCC ID: N7NMC7355 / IC ID: 2417C-MC7355 (see product bottom label)

cell-4g1-x.x.x.mpk = Orbit cell firmware image (4G1\*), AT&T

cell-4g2-x.x.x.mpk = Orbit cell firmware image (4G2\*), Rogers

cell-4g3-x.x.x.mpk = Orbit cell firmware image (4G3\*), Telus

cell-4g4-x.x.x.mpk = Orbit cell firmware image (4G4\*), Bell Canada

cell-4g5-x.x.x.mpk = Orbit cell firmware image (4G3\*), Verizon Wireless

Firmware compatible with Europe, Middle East and APAC MCR/ECR 4G LTE modules:

cell-e4s-x.x.x.mpk = Orbit cell firmware image (E4S\*), international - not carrier specific

cell-e42-x.x.x.mpk = Orbit cell firmware image (E42\*), international - Telstra Specific

\*Online store configuration string code corresponding to a 4G LTE carrier specific configuration

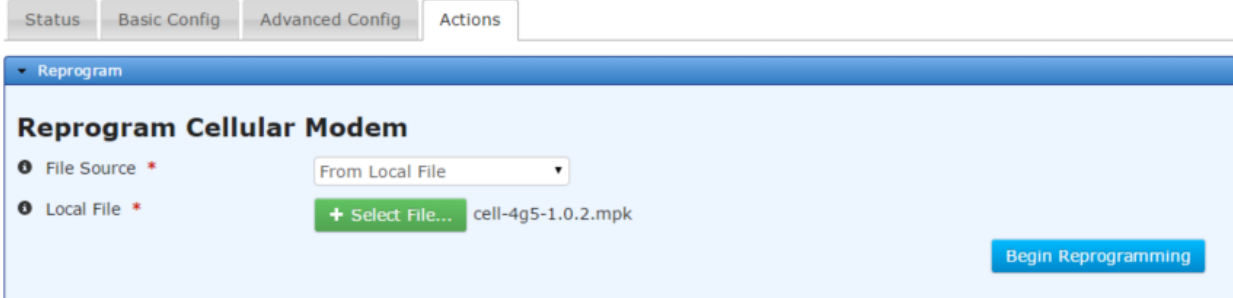
## Configuring

To start reprogramming the cell modem firmware, navigate to the **Reprogram Cellular Modem** section. The following example shows how to upload a cell modem firmware image file through the web browser and reprogram the cel modem with that image file.

Navigate to *Interfaces / Cell ---> Actions / Reprogram*

Click on the **Begin Reprogramming** button once the file source is configured.

### Cell Interface



The screenshot shows a web interface for reprogramming a cellular modem. At the top, there are four tabs: 'Status', 'Basic Config', 'Advanced Config', and 'Actions'. The 'Actions' tab is selected. Below the tabs is a blue header bar with the text 'Reprogram'. Underneath, the main section is titled 'Reprogram Cellular Modem'. It contains two rows of configuration options. The first row is 'File Source' with a dropdown menu currently set to 'From Local File'. The second row is 'Local File' with a green button labeled '+ Select File...' and the text 'cell-4g5-1.0.2.mpk' next to it. At the bottom right of this section is a blue button labeled 'Begin Reprogramming'.

**Figure 3-29. Reprogram Cellular Modem**

The MCR supports file uploads through a web browser from a local file on the user's PC. The MCR also supports HTTP, FTP, TFTP, and SFTP file downloads using external remote servers.

- **File Source** - File transfer method to use. Available choices are From Local File (DEFAULT), From HTTP Server, From FTP Server, From TFTP Server, and From SFTP Server. Local file uploads are only available through the web UI and not through the CLI
- **Local File** - For a local file, the file to upload as chosen by the file dialog popped up by the **Select File...** button
- **URL** - For HTTP, the location of the source file
- **Server Address** - For FTP, TFTP, and SFTP, the remote server's host name or IP address
- **File Path** - For FTP, TFTP, and SFTP, the path to the source file on the remote server
- **User Name** - For FTP and SFTP, the user name on the remote server



- **Password** - For FTP and SFTP, the password on the remote server
- **Control Port** - For FTP, the TCP control port (advanced setting - use default)
- **Data Port** - For FTP, the TCP data port (advanced setting - use default)
- **Block Size** - For TFTP, the block size as defined in RFP 2348 (advanced setting - use default)
- **Timeout** - For FTP, TFTP, and SFTP, the timeout in seconds (advanced setting - use default)

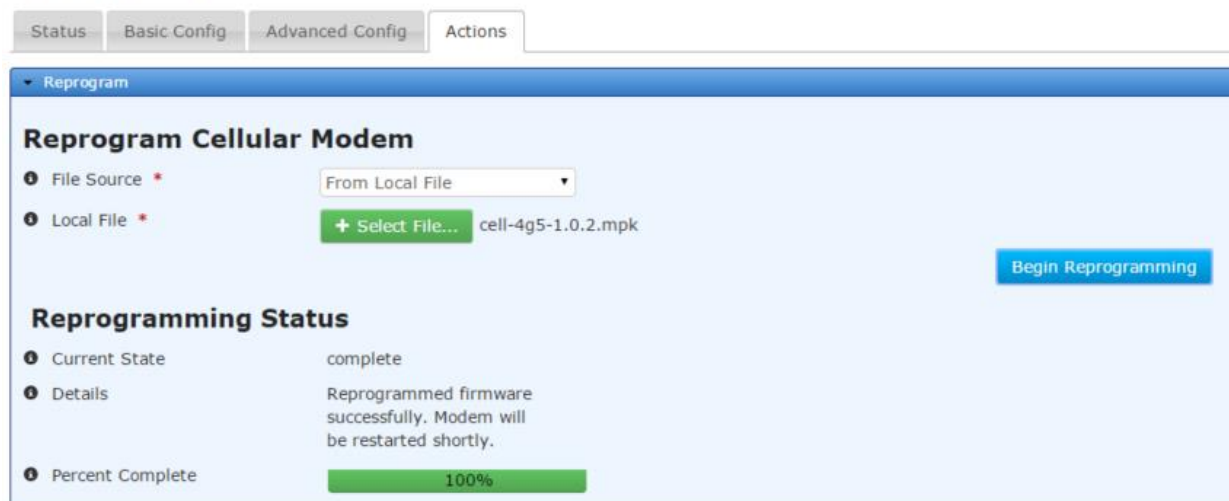
The following example shows how to have the device download a cell modem firmware image (named cell-4g5-1.0.2.mpk) from a TFTP server running on a host (address 192.168.1.10) that is accessible from the MCR (e.g. a locally connected host or remote host accessible via cellular interface). To start reprogramming the cell modem firmware from the CLI, enter the following command to download the firmware image from the TFTP server:

```
> request interfaces interface Cell firmware reprogram filename cell-4g5-1.0.2.mpk manual-  
file-server { tftp { address 192.168.1.10 } }
```

## Monitoring - Reprogram

Once the reprogramming is begun, the process may be cancelled by clicking the **Cancel Reprogramming** button. The current status of the reprogramming process is displayed on the web page. Note that the web page does not display the current status if the device has not been instructed to reprogram (in other words, if the state is “inactive”).

### Cell Interface



The screenshot displays the 'Reprogram Cellular Modem' web interface. At the top, there are tabs for 'Status', 'Basic Config', 'Advanced Config', and 'Actions'. The main content area is titled 'Reprogram Cellular Modem' and includes a 'File Source' dropdown menu set to 'From Local File'. Below this, there is a 'Local File' field with a '+ Select File...' button and the filename 'cell-4g5-1.0.2.mpk'. A 'Begin Reprogramming' button is located to the right. The 'Reprogramming Status' section shows the following information:

Current State	complete
Details	Reprogrammed firmware successfully. Modem will be restarted shortly.
Percent Complete	100%

**Figure 3-30. Reprogram Cellular Modem Monitoring**

The reprogramming status contains the following items:

- **Current State** – The status of the reprogramming task:
  - inactive
  - transferring
  - processing
  - cancelling
  - complete
  - failure
  - cancelled
- **Detailed Message** – The details regarding the operation, such as “*Processing cellular modem firmware image*”



- **Size** – The total number of bytes in the image (not displayed on the web UI)
- **Bytes Transferred** – The number of bytes already transferred or processed (not displayed on the web UI)
- **Percent Complete** – The percentage complete for the operation

To view the status of the reprogramming process in the CLI, ensure the CLI is in operational mode and then follow the example below:

```
> show system firmware reprogram-status
system firmware reprogram-status state complete
system firmware reprogram-status detailed-message "Reprogrammed firmware
successfully. Modem will be restarted shortly."
system firmware reprogram-status size 34849644
system firmware reprogram-status bytes-transferred 34849644
system firmware reprogram-status percent-complete 100
```

### 3.5.3 WiFi

#### Understanding

The Orbit MCR device may be configured to have an internal WiFi module that has FCC/CE modular approval. The WiFi module can be configured to operate as an 802.11b/g/n Access Point or Station. The specifications for the WiFi module are covered in “LN400 – 101D-LN400

LN900 – 101D-LN900

2.4 GHz WiFi Specifications” on Page 385. The table below contains the list of GE MDS approved antennas.

**Table 3-6. Approved Cell Antenna Types**

Application	Location	Frequency Range	Gain	Antenna Description	GE MDS Part Number
WiFi	Indoor	2.4-2.5 GHz	3.2 dBi	Direct Connect, RP SMA, Dipole Whip	97-4278A34
WiFi accessory	Indoor	--	--	Magnetic Mount, 5 ft./1.52 m Cable, RP SMA Plug use with above	97-4278A78
WiFi	Outdoor	2.4-2.5 GHz	2 dBi	External Mount, Omni Ant. with N-Male connector - no cable	97-4278A48
WiFi	Outdoor	2.4-2.5 GHz	7.85 dBd (10dBi)	Enclosed Yagi Ant. with 18" coax to N-Female connector	97-4278A01
WiFi	Outdoor	2.4-2.5 GHz	10.85 dBd (13dBi)	Panel Ant. Linear, Vertical/Horizontal with N-Female connector - no cable	97-4278A16

The unit supports the following WiFi security modes:

1. None (should be used only to test connectivity)
2. WPA2 + CCMP/AES Encryption – This mode should be used if all client devices support WPA2/CCMP.
3. CCMP/AES Encryption + TKIP Encryption – This mode should be used if there is mix of both legacy client devices that only support WPA/TKIP and newer devices that support WPA2/CCMP.



In this mode, stations must select only TKIP or AES/CCMP + TKIP. Stations cannot specify only AES/CCMP. Table 3-7 shows the valid combinations of Station Encryption settings that will work for a given AP Encryption setting.

**Table 3-7: WPA Enterprise Combinations**

AP Encryption	Station Encryption Choices
AES/CCMP	AES/CCMP AES/CCMP + TKIP
TKIP	TKIP AES/CCMP + TKIP
AES/CCMP + TKIP	TKIP AES/CCMP + TKIP

Also, WPA and WPA2 can be configured further in following modes:

- **Personal** – This uses pre-shared keys (passphrases) configured on the MCR and client devices.
- **Enterprise** – This supports EAP-TLS based authentication of client devices (configured with certificates/keys) via RADIUS.

The default SSID is based on the unit’s serial number and takes the form of: **GEMDS\_<SERNUM>** (the serial number is printed on the chassis sticker). The default password for WiFi operation is **GEMDS\_ORBIT**.

The table below describes the Orbit MCR’s LED behavior when using the WiFi interface. The LED for the NIC varies, depending on the configuration of the MCR. When equipped with 900 MHz support, WiFi information is in NIC 1; otherwise, it is in NIC 2.

**Table 3-8. WiFi Interface LED Descriptions**

LED - NIC1 or NIC2	State	Description
WiFi Interface	Off	Interface disabled
Access Point Mode	Solid Green Solid Red	Operating as AP and at least one client connection Operating as an AP and no client connection
Station Mode	Off Solid Green	No connection Wi-Fi connection established.

## Configuring

Configuring the WiFi begins with the following UI:

Navigate to: **Interfaces / Wi-Fi ---> Basic Config / Wi-Fi / Wifi Config**



## Wi-Fi Interface ↻

Status Basic Config Advanced Config Actions

General

Wi-Fi

Wifi Config

Mode

Tx Power

Figure 3-31. WiFi Mode /Power Configuration Screen

- **Mode** - WiFi Mode
  - Station - makes connection to a WiFi Access Point
  - Access Point – provides WiFi connections to multiple Stations
- **Tx Power** - The transmission power of the WiFi interface – Valid Values are 1to18 (dBm), DEFAULT - 15 dBm.

### 3.5.3.1 AP Mode Configuration

To configure the parameters necessary for Access Point mode, start by using the following section of the web UI:

Navigate to: *Interfaces / Wi-Fi ---> Basic Config / Wi-Fi*

Status Basic Config Advanced Config Actions

General

Wi-Fi

Wifi Config

Mode

Tx Power

Ap Config

**Ap**

Search  Add ... Delete

Ssid	Broadcast Ssid	Station Max	Station Timeout	Beacon Interval	Privacy Mode	Psk Config - Encryption
Table is empty						

Channel

Operation Mode

Dtim Period

Rts Threshold

Fragm Threshold

Figure 3-32. WiFi AP SSID Configuration Screen

Each AP Profile contains specific information to be selected. For each SSID, however, certain parameters are shared between each AP. The parameters are:

- **Channel** – IEEE 802.11 channel number to operate on. Valid values 1-11, DEFAULT - 6.
- **Operation Mode** - IEEE 802.11 mode to operate in.





- 802.11b
- 802.11g
- 802.11n

**NOTE** The following are advanced WiFi network settings and should only be modified with the assistance of a network engineer.

- **Dtim Period** – DTIM (delivery traffic information message) period. The number of beacons between DTIMs. Valid Values: 1-255, DEFAULT - 2.
- **Rts Threshold** – RTS/CTS Threshold. Valid Values 0-2347, DEFAULT - 2347 (disabled).
- **Fragm Threshold** –Fragmentation Threshold. Valid Values 0-2346, DEFAULT - 2346 (disabled).

To add an AP, click on the **ADD** button, or to delete an AP, click on the SSID and then the Delete button. By default, an access point will be configured with the SSID, **GEMDS <SERNUM>** and the WiFi password, **GEMDS-ORBIT**. To edit an AP, click on the SSID of the configured network. In the following example, the SSID is **GEMDS\_2344676**.

**Configure Ap Details**

Ssid\*

**Configure Ap Details**

Broadcast Ssid

Station Max

Station Timeout

Beacon Interval

Privacy Mode

**Psk Config**

Encryption

Key Mgmt

Psk

Vlan Mode

**Figure 3-33. WiFi AP Details Configuration Screen**

- **Broadcast Ssid** – If checked (true), the SSID will be broadcast.
- **Station Max** – The maximum number of clients that will be allowed to connect to this access point. Valid values: 1-max (7 = DEFAULT, max = 7 )
- **Station Timeout** – The number of seconds a station may be inactive before the access point will verify that the station is still within range. Valid values: 1-300 (300 = DEFAULT)



- **Beacon Interval** – The number of seconds between WiFi beacon transmissions. Valid values: 15-65535. (100 = DEFAULT)
- **Privacy Mode** – The privacy mode to use on this interface.
  - None
  - Wpa 2 Personal (DEFAULT)
  - Wpa 2 Enterprise
  - Wpa 2 Personal Mixed
  - Wpa 2 Enterprise Mixed
- **Encryption** – The encryption mode to use
  - Ccmp - AES-based encryption mechanism that is stronger than TKIP for WPA2
  - Tkip - a stream cipher is used with a 128-bit per-packet key, meaning that it dynamically generates a new key for each packet for WPA
  - Ccmp Tkip – allows a mixture of WPA and WPA2 clients
  
- **Key Mgmt** – The type of preshared key to use
  - Wpa Psk
  - Wpa Psk sha 256
  - Psk – The Preshared Key 8 to 64 characters, DEFAULT = <blank>.
- **Vlan Mode** – VLAN configuration for the WiFi Interface
  - None
  - Access - Only one VLAN can be configured on an access interface; traffic carried for only one VLAN.
  - Trunk - Two or more VLANs configured on a trunk port; several VLANs can be carried simultaneously.

---

**NOTE** Remember to click on **SAVE** when finished.

---

The CLI commands below show how the WiFi settings are made. The unit must be in Configuration Mode to make these settings. Each command string begins with the word set:

```
% set interfaces interface Wi-Fi wifi-config mode access-point ap-config ap GEMDS_<SERNUM>
broadcast-ssid true privacy-mode wpa2-personal psk-config psk GEMDS_ORBIT
```

### 3.5.3.2 Dual-SSID Functionality (AP mode only)

The Orbit MCR supports up to two SSIDs to be configured when the Wi-Fi interface is set to an Access Point. The first SSID should be reserved for high throughput data paths. The second SSID is intended to support auxiliary applications such as a dedicated management connection or guest LAN access. The following example demonstrates having a second Wi-Fi AP with the SSID:

Ssid	Broadcast Ssid	Station Max	Station Timeout	Beacon Interval	Privacy Mode	Psak Config - Encryption
GEMDS_2344676	true	7	300	100	wpa-personal	ccmp
GEMDS_2_2344676	true	7	300	100	wpa-personal	ccmp

Showing 1 to 2 of 2



**Figure 3-34. WiFi AP Configuration**

To set up a second WiFi access point with the CLI, use the following command by substituting the different SSID and PSK for the new configuration.

```
% set interfaces interface Wi-Fi wifi-config mode access-point ap-config channel 3 operation-mode 80211n ap GEMDS_2_<SERNUM> broadcast-ssid true privacy-mode wpa2-personal psk-config psk GEMDS_ORBIT2 encryption ccmp-tkip
```

**Operational Notes Regarding Dual SSID**

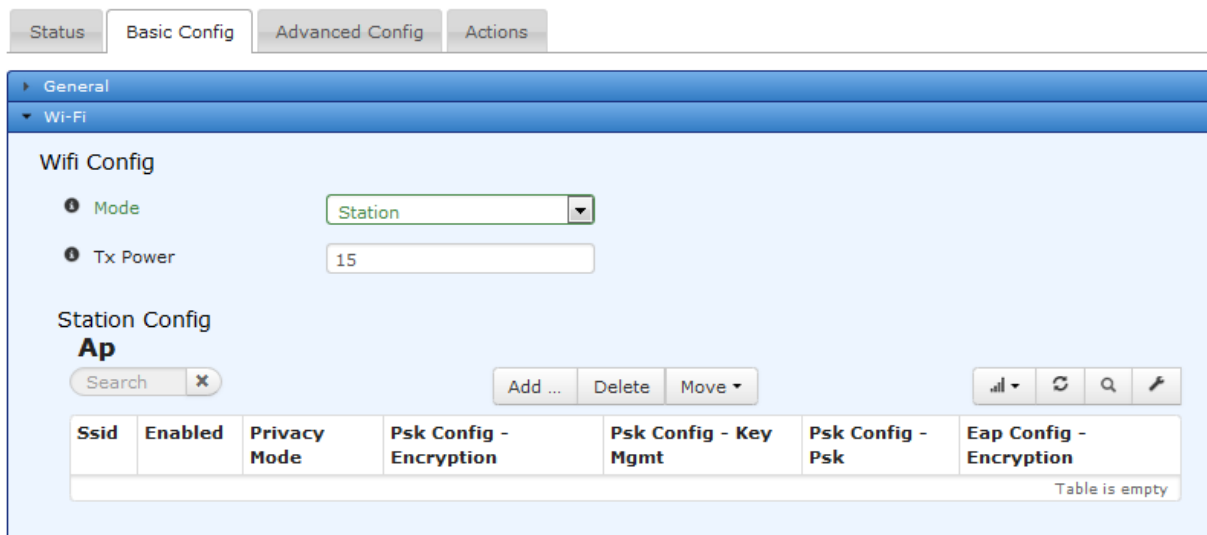
- The channel, operation mode, tx-power, dtim-period, rts-threshold and fragm-threshold parameters are shared between the two SSIDs.
- The Orbit MCR organizes the SSIDs in alphabetical order. If an SSID of *ssidexample* exists and a second SSID of *examplssid* is created, this will become the first SSID and the SSID *ssidexample* will become the second SSID.
- Each SSID is independent of the other, except for the parameters noted above. Each SSID can be in or out of the bridge. However, to use VLANs, the SSIDs must be bridged.

**3.5.3.3 Station Mode**

To configure the WiFi interface as a station, start at the following:

Navigate to: **Interfaces / Wi-Fi ---> Basic Config / Wi-Fi**

**Wi-Fi Interface**



**Figure 3-35. WiFi Station Configuration**

- **Mode** - WiFi Mode
  - Station - makes connection to a WiFi Access Point
  - Access Point – provides WiFi connections to multiple Stations
- **Tx Power** - The transmission power of the WiFi interface – Valid Values 1 to 18 (dBm), DEFAULT - 15 dBm.

Select *Station* from the drop down. In *Station Config*, add a new AP by clicking on the *ADD* button. Enter the SSID of the AP to have the station associate to it. Then, click on the *ADD* button to enter additional details about the Wi-Fi AP.

In the following example, the SSID of *SOMESSID* is used.



Navigate to: *Interfaces / Wi-Fi ---> Basic Config / Wi-Fi*

**Configure Ap Details**

Ssid\*

---

**Configure Ap Details**

Enabled

Privacy Mode

**Psk Config**

Encryption

Key Mgmt

Psk

**Figure 3-36. WiFi Configuration Settings**

- **Enabled** – Check the box to enable the WiFi interface.
- **Privacy Mode** – The privacy mode to use on this interface.
  - None (DEFAULT)
  - Wpa 2 Personal
  - Wpa 2 Enterprise
  - Wpa 2 Personal Mixed
  - Wpa 2 Enterprise Mixed
- **Encryption** – The encryption mode to use
  - Ccmp - AES-based encryption mechanism that is stronger than TKIP for WPA2
  - Tkip - a stream cipher is used with a 128-bit per-packet key, meaning that it dynamically generates a new key for each packet
  - Ccmp Tkip – allows a mixture of WPA and WPA2 clients
- **Key Mgmt** – The type of preshared key to use
  - Wpa Psk
  - Wpa Psk sha 256
- **Psk** – The Preshared Key 8 to 64 characters, DEFAULT = <blank>.

---

**NOTE** Remember to click on the **Save** button when finished.

---

## Monitoring:

### General WiFi status information

The following UI screens are read-only. *Navigate to: Interfaces / Wi-Fi ---> Status / General*



## Wi-Fi Interface [↗](#)

Status Basic Config Advanced Config Actions

General

Type*	wifi	Refresh every <input type="text"/>
Admin Status*	down	seconds
Oper Status*	not-present	
If Index*	5	
Phys Address		

**Figure 3-37. WiFi Status Information**

- **Type** - The type of the interface
- **Admin Status** - The desired state of the interface. (“Up” - meaning operational)
- **Oper Status** - The current operational state of the interface.

**NOTE** The following information is useful for are advanced WiFi users for debugging.

- **If Index** - The if Index value for the if Entry represented by this interface. Valid values: 1—2147483647
- **Phys Address**- The interface's address at its protocol sub-layer. For example, for an 802.x interface, this object normally contains a MAC address. The interface's media-specific modules must define the bit and byte ordering and the format of the value of this object. For interfaces that do not have such an address (e.g., a serial line), this node is not present.

General

Statistics

Discontinuity Time*	Wed, 26 Nov 2014 16:03:39 GMT	Refresh every <input type="text"/>
In Octets	0	seconds
In Unicast Pkts	0	
In Broadcast Pkts		
In Multicast Pkts	0	
In Discards	0	
In Errors	0	
In Unknown Protos		
Out Octets	0	
Out Unicast Pkts	0	
Out Broadcast Pkts		
Out Multicast Pkts		
Out Discards	0	
Out Errors	0	

**Figure 3-38. WiFi Statistics Information**

**NOTE** The following information is reset on system reboot or power cycle.

- **Discontinuity Time** - The time on the most recent occasion at which one or more of this interface's counters suffered a discontinuity.
- **In Octets** - The total number of octets received on the interface, including framing characters.
- **In Unicast Pkts** - The number of packets, delivered by this sub-layer to a higher (sub-) layer, which were not addressed to a multicast or broadcast address at this sub-layer.



- **In Broadcast Pkts** - The number of packets, delivered by this sub-layer to a higher (sub-) layer, which were addressed to a broadcast address at this sub-layer.
- **In Multicast Pkts** - The number of packets, delivered by this sub-layer to a higher (sub-) layer, which were addressed to a multicast address at this sub-layer.
- **In Discards** - The number of inbound packets which were chosen to be discarded even though no errors had been detected to prevent their being deliverable to a higher-layer protocol. One possible reason for discarding such a packet could be to free up buffer space.
- **In Errors** - For packet-oriented interfaces, the number of inbound packets that contained errors preventing them from being deliverable to a higher-layer protocol.
- **In Unknown Protos** - For packet-oriented interfaces, the number of packets received via the interface which were discarded because of an unknown or unsupported protocol.
- **Out Octets** - The total number of octets transmitted out of the interface, including framing characters.
- **Out Unicast Pkts** - The total number of packets that higher-level protocols requested be transmitted, and which were not addressed to a multicast or broadcast address at this sub-layer, including those that were discarded or not sent.
- **Out Broadcast Pkts** - The total number of packets that higher-level protocols requested be transmitted, and which were addressed to a broadcast address at this sub-layer, including those that were discarded or not sent.
- **Out Multicast Pkts** - The total number of packets that higher-level protocols requested be transmitted, and which were addressed to a multicast address at this sub-layer, including those that were discarded or not sent.
- **Out Discards** - The number of outbound packets which were chosen to be discarded even though no errors had been detected to prevent their being transmitted.
- **Out Errors** - For packet-oriented interfaces, the number of outbound packets that could not be transmitted because of errors.

#### 3.5.3.4 WiFi Status When Configured as an AP:

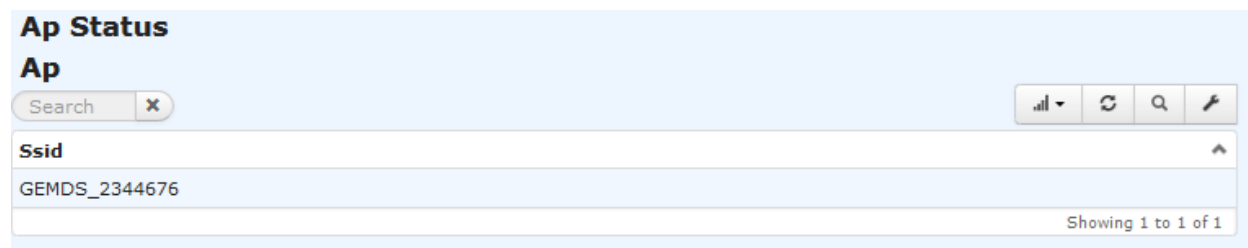
Serial Number	n722m3anu000867	Refresh every <input type="text"/> seconds
Mode	access-point	
Tx Power	15	
Channel	6	

**Figure 3-39. WiFi AP Status Information**

- **Serial Number** – Internal WiFi module serial number
- **Mode** - WiFi Mode
  - Station - makes connection to a WiFi Access Point
  - Access Point – provides WiFi connections to multiple Stations
- **Tx Power** - The transmission power of the WiFi interface – Valid Values 1-18 (dBm)
- **Channel** – IEEE 802.11 channel number to operate on. Valid values 1-11.
- **Ap Status** - link to information regarding the Ap linked to this station - as shown below



### 3.5.3.5 WiFi AP Status:



**Figure 3-40. WiFi AP Status Information**

- **Mac** - Hardware Id of connected device.
- **Rssi** - Received Signal Strength Indication - possible values are: -20 to -90 dBm
- **Authenticated** – indicates the client is valid to connect - True/False
- **Authorized** – indicates the client has valid logon credentials - True/False
- **Inactive** – milliseconds since last packet
- **Rxbytes** – received byte count
- **Rxpackets** – received packet count

### 3.5.3.6 WiFi Status When Configured as a Station:



**Figure 3-41. WiFi Station Statistics Information**

- **Ssid** - SSID of access point to which the unit is connected - up to 32 characters.
- **Bssid** – Basic SSID of access point to which the unit is connected - up to 32 characters
- **Rssi** - Received Signal Strength Indication - possible values are: -20 to -90 dBm
- **Authenticated** – indicates the client is valid to connect - True/False
- **Authorized** – indicates the client has valid logon credentials - True/False
- **Inactive** – milliseconds since last packet



- **Rxbytes** – Received byte count
- **Rxpackets** – Received packet count
- **Txbitrate** – Transmit bit rate
- **Txbytes** – Transmitted byte count
- **Txpackets** – Transmitted packet count
- **Txfailed** – Transmit packet failures
- **Txretries** – Transmit packet retries

### 3.5.3.7 Using CLI Commands

#### AP Mode Configuration

The following will configure a basic access point with an SSID of somessid running in 802.11g mode to verify connectivity:

```
% set interfaces interface Wi-Fi wifi-config mode access-point ap-config operation-mode
80211g ap somessid

% show interfaces interface Wi-Fi wifi-config | details
mode access-point;
tx-power 15;
ap-config {
  ap somessid {
    broadcast-ssid true;
    station-max 7;
    station-timeout 300;
    beacon-interval 100;
    privacy-mode none;
    vlan-mode none;
  }
  channel 6;
  operation-mode 80211g;
  dtim-period 2;
  rts-threshold 2347;
  fragm-threshold 2346;
}
```

#### Privacy Mode Configuration via CLI

The default privacy mode is *wpa2-personal*. (The privacy mode in the previous example was set to **none**.) The following configures the unit to use WPA2-Personal security with the default of CCMP/AES encryption and disables the broadcasting of the SSID.

```
% set interfaces interface Wi-Fi wifi-config ap-config ap somessid broadcast-ssid false privacy-
mode wpa2-personal psk-config psk somepassphrase encryption ccmp
% show interfaces interface Wi-Fi wifi-config | details
mode access-point;
tx-power 15;
ap-config {
  ap somessid {
    broadcast-ssid false;
    station-max 7;
    station-timeout 300;
    beacon-interval 100;
    privacy-mode wpa2-personal;
  }
}
```





```
    psk-config {
        encryption    ccmp;
        key-mgmt      wpa-psk;
        psk           somepassphrase;
    }
    vlan-mode        none;
}
channel            6;
operation-mode     80211g;
dtim-period        2;
rts-threshold      2347;
fragm-threshold    2346;
}
```

The next example takes the previous configuration and changes the security to WPA2-Personal with CCMP/AES + TKIP encryption.

```
% set interfaces interface Wi-Fi wifi-config ap-config ap somessid broadcast-ssid false privacy-
mode wpa2-personal psk-config psk somepassphrase encryption ccmp-tkip

% show interfaces interface Wi-Fi wifi-config | details
mode    access-point;
tx-power 15;
ap-config {
    ap somessid {
        broadcast-ssid    false;
        station-max       7;
        station-timeout   300;
        beacon-interval   100;
        privacy-mode      wpa2-personal;
        psk-config {
            encryption    ccmp-tkip;
            key-mgmt      wpa-psk;
            psk           somepassphrase;
        }
        vlan-mode        none;
    }
    channel            6;
    operation-mode     80211g;
    dtim-period        2;
    rts-threshold      2347;
    fragm-threshold    2346;
}
```

## Other configurations

The following configures the device to broadcast its SSID, support 802.11b/g/n modes and operate on channel 3.

```
% set interfaces interface Wi-Fi wifi-config ap-config operation-mode 80211n channel 3 ap
somessid broadcast-ssid true privacy-mode wpa2-personal psk-config psk somepassphrase
encryption ccmp-tkip

% show interfaces interface Wi-Fi wifi-config | details
mode    access-point;
```



```
tx-power 15;
ap-config {
  ap somessid {
    broadcast-ssid      true;
    station-max         7;
    station-timeout     300;
    beacon-interval     100;
    privacy-mode        wpa2-personal;
    psk-config {
      encryption        ccmp-tkip;
      key-mgmt          wpa-psk;
      psk                somepassphrase;
    }
    vlan-mode           none;
  }
  channel              3;
  operation-mode        80211n;
  dtim-period          2;
  rts-threshold         2347;
  fragm-threshold       2346;
}
```

### Dual-SSID Functionality (AP mode only)

The Orbit MCR supports up to two SSIDs to be configured when the Wi-Fi interface is set to an Access Point. The first SSID should be reserved for high throughput data paths. The second SSID is intended to support auxiliary applications such as a dedicated management connection or guest LAN access. The following example sets up a second Wi-Fi AP with the SSID of **somessid2** to the previous example's SSID **somessid**.

```
% set interfaces interface Wi-Fi wifi-config mode access-point ap-config channel 3 operation-
mode 80211n ap somessid2 broadcast-ssid true privacy-mode wpa2-personal psk-config
psk somepassphrase2 encryption ccmp-tkip
```

```
% show interfaces interface Wi-Fi wifi-config | details
```

```
mode access-point;
tx-power 15;
ap-config {
  ap somessid {
    broadcast-ssid      true;
    station-max         7;
    station-timeout     300;
    beacon-interval     100;
    privacy-mode        wpa2-personal;
    psk-config {
      encryption        ccmp-tkip;
      key-mgmt          wpa-psk;
      psk                somepassphrase;
    }
    vlan-mode           none;
  }
  ap somessid2 {
    broadcast-ssid      true;
    station-max         7;
```



```
station-timeout      300;
beacon-interval      100;
privacy-mode         wpa2-personal;
psk-config {
  encryption          ccmp-tkip;
  key-mgmt             wpa-psk;
  psk                  somepassphrase2;
}
vlan-mode            none;
}
channel              3;
operation-mode        80211n;
dtim-period           2;
rts-threshold         2347;
fragm-threshold       2346;
}
```

### Operational Notes Regarding Dual SSID

- The channel, operation mode, tx-power, dtim-period, rts-threshold and fragm-threshold parameters are shared between the two SSIDs.
- The Orbit MCR organizes the SSIDs in alphabetical order. If an SSID of *somessid* exists and a second SSID of *somessid2* is created, this will become the first SSID and the SSID *somessid2* will become the second SSID.
- Each SSID is independent of the other, except for the parameters noted above. Each SSID can be in or out of the bridge. However, to use VLANs, the SSIDs must be bridged.

### Station Mode

This sets the unit to act as a WiFi station to connect to an AP with *somessid* and WPA2 Personal security.

```
% set interfaces interface Wi-Fi wifi-config mode station station-config ap somessid enabled
true privacy-mode wpa2-personal psk-config psk somepassphrase encryption ccmp

% show interfaces interface Wi-Fi | details
enabled      true;
wifi-config {
  mode station;
  tx-power 15;
  station-config {
    ap somessid {
      enabled      true;
      privacy-mode wpa2-personal;
      psk-config {
        encryption ccmp;
        key-mgmt   wpa-psk;
        psk        somepassphrase;
      }
    }
  }
}
type wifi;
```



## Monitoring

Ensure the CLI is in Operational mode.

### Access Point Mode

The examples on the following pages shows status and statistics of the WiFi interface with two stations connected.

```
> show interfaces-state interface Wi-Fi wifi-status
wifi-status serial-number n722m3anu000867
wifi-status mode "Access Point"
wifi-status tx-power 15
wifi-status channel 4
wifi-status ap-status ap MDS_ORBIT
  client 00:0e:35:ba:67:36
    rssi      -65
    authenticated true
    authorized true
    inactive  16940
    rxbytes   29134
    rxpackets 622
    txbitrate 1
    txbytes   25987
    txpackets 265
    txfailed  0
    txretries 0

> show interfaces-state interface Wi-Fi statistics
statistics discontinuity-time 2013-09-24T13:12:25-04:00
statistics in-octets 3747
statistics in-unicast-pkts 26
statistics in-multicast-pkts 0
statistics in-discards 0
statistics in-errors 0
statistics out-octets 55511
statistics out-unicast-pkts 215
statistics out-discards 0
statistics out-errors 0
```

### Station Mode

The following shows status when connected to a configured Wi-Fi AP.

```
> show interfaces-state interface Wi-Fi wifi-status
wifi-status serial-number N722M33NU000628
wifi-status mode Station
wifi-status tx-power 15
wifi-status channel 4
wifi-status station-status ssid somessid
wifi-status station-status bssid 00:19:70:2c:40:3f
wifi-status station-status rssi -58
wifi-status station-status authenticated true
wifi-status station-status authorized true
wifi-status station-status inactive 29270
wifi-status station-status rxbytes 27119
```



```
wifi-status station-status rxpackets 564
wifi-status station-status txbitrate 54
wifi-status station-status txbytes 897
wifi-status station-status txpackets 9
wifi-status station-status txfailed 0
wifi-status station-status txretries 0

> show interfaces-state interface Wi-Fi statistics
statistics discontinuity-time 2013-09-24T13:12:25-04:00
statistics in-octets 288
statistics in-unicast-pkts 2
statistics in-multicast-pkts 0
statistics in-discards 0
statistics in-errors 0
statistics out-octets 752
statistics out-unicast-pkts 7
statistics out-discards 0
statistics out-errors 0
```

### 3.5.4 Unlicensed 900 MHz ISM (NX915)

#### Understanding

The 900 MHz ISM Module (NX915) interface provides operation in the 900 MHz unlicensed ISM band. The module provides long-distance communications with data rates ranging from 125 kbps to 1.25 Mbps, suitable to interface both Ethernet and Serial controllers such as PLCs, RTUs and SCADA systems. The module utilizes a combination of FHSS (Frequency Hopping Spread Spectrum), DTS (Digital Transmission System) and hybrid FHSS/DTS technologies to provide dependable wireless communications.

The GE MDS NX915 NIC module is a point-to-multipoint, medium speed, long range (>20 miles), spread-spectrum, wireless data transmission product. It operates as a Frequency-Hopping Spread Spectrum (FHSS) or a Digital Transmission System (DTS) in the 902 to 928 MHz license-free ISM band. The NIC can operate as an Access Point, a Remote, or a Store and Forward (SAF) device. It will operate as an intentional radiator in accordance with FCC Rule Part 15.247 under full modular rules per DA 00-1407.

The specifications for the 900 MHz NX915 NIC module:

- Frequency Range: 902 to 928 MHz
- Power Output: 20 dBm to 30 dBm in 1.0 dBm steps (DEFAULT = 30 dBm)
- Output Impedance: 50 Ohms
- Permissible Antennas: See Table 3-10 below
- Antenna Connector: TNC female
- Number of Frequency Channels: Selectable 50 to 81 for FHSS, 1 to 20 for DTS
- Channel Separation: 307.5 kHz minimum
- Modulation Type: 2-Level GFSK / 4-Level GFSK
- Data Rates: 125, 250, 500, 1000, 1000W, 1250 kbps
- Peak Frequency Deviation: 1250 kbps / 4-level GFSK: 550 kHz
- Beacon Interval: 10 to 300 ms (DEFAULT is 150)
- Dwell Time: 10 to 400 ms (DEFAULT is 50)



- FCC Part 15.247 under modular rules per DA00-1407
- FCC ID: E5MDS-NX915
- ICID: 101D-NX915
- Six modulation rate / bandwidth combinations; as seen in Table 3-9:

**Table 3-9. Modulation and Bandwidth Combinations**

	125	250	500	1000N*	1000W*	1250
<b>Mode</b>	FHSS	FHSS	DTS	DTS	DTS	DTS
<b>Rate (kbps)</b>	125	250	500	1000	1000	1250
<b>Channels</b>	80	80	80	80	80	80
<b>Modulation</b>	2-GFSK	2-GFSK	2-GFSK	4-GFSK	4-GFSK	4-GFSK
<b>RF Bandwidth</b>	152 kHz (20dB)	300 kHz (20dB)	505 kHz (6 dB)	680 kHz (6 dB)	933 kHz (6 dB)	1320 kHz (6 dB)
<b>Sensitivity 1x10<sup>-6</sup></b>	-105 dBm	-103 dBm	-99 dBm	-92 dBm	-95 dBm	-95 dBm

\*1000N occupies 250 kHz less spectrum bandwidth than 1000W which is why it has a "narrower bandwidth", this comes with a ~2-3 dBm reduction in sensitivity when compared to 1000W kbps. For clear spectrum, use 1000W, for unknown or busy spectrum it's safer to use the narrow 1000N modem.

**Table 3-10. Approved NxRadio Antenna Types**

Application	Location	Frequency Range	Gain	Antenna Description	GE MDS Part Number
900 MHz (NX915)	Indoor	902-928MHz	2 dBi	Omni Indoor Flex	97-2952A01
900 MHz (NX915)	Indoor	902-928MHz	5 dBi	Omni with 16" N-F Connect and Mount	97-3194A16
900 MHz (NX915)	Outdoor	902-960MHz	10 dBd (12.15 dBi)	Yagi 6 Element, N-Female - no cable	97-3194A14
900 MHz (NX915)	Outdoor	902-960MHz	10 dBd (12.15 dBi)	Yagi 6 Element, N-Female - with 10' Jumper N-M and Mount	97-3194A14A
900 MHz (NX915)	Outdoor	902-960MHz	10 dBd (12.15 dBi)	Yagi 6 Element, N-Female - with 15' Jumper N-M and Mount	97-3194A14B
900 MHz (NX915)	Outdoor	902-960MHz	6.4 dBd (8.55 dBi)	Yagi 3 Element N-Female - no cable	97-3194A13
900 MHz (NX915)	Outdoor	902-960MHz	6.4 dBd (8.55 dBi)	Yagi 3 Element N-Female – with 10' Jumper N-M and Mount	97-3194A13A



900 MHz (NX915)	Outdoor	902-960MHz	6.4 dBd (8.55 dBi)	Yagi 3 Element N-Female – with 15' Jumper N-M and Mount	97-3194A13B
900 MHz (NX915)	Outdoor	902-960MHz	6.4 dBd (8.55 dBi)	Yagi 3 Element N-Female – with 25' Jumper N-M and Mount	97-3194A13C
900 MHz (NX915)	Outdoor	902-928MHz	7 dBd (9.15 dBi)	5/8-wavelength Omni Ant. with 16" coax to N-Female connector	97-3194A17

For the 900MHz radio (NX915) – If the installed antenna network does not provide the proper load matching, an alarm is generated by the unit to indicate a VSWR Error condition. This must be corrected in order for the radio to operate properly and to ensure optimal operation.

**NOTE** The only required steps for basic configuration are programming a network name in all units and establishing one unit as the AP.

Minimal configuration is necessary but several advanced tuning facilities are provided.

Frequency operating range is restricted by pre-set factory calibration to ensure compliance with applicable country-specific regulatory requirements. Frequency operating range can be further restricted by user input to avoid select portions of the operating band. This is sometimes helpful when attempting to collocate a network with another 900MHz network, such as the MDS iNET or TransNET. For example the iNET network can be configured to operate in the top half of the band while the Orbit can have its NX915 module configured for the lower half.

By default the radio ships from the factory with the 500kbps modem selected. Dwell time is set to 50ms and Hop Set A is enabled. For typical configuration (e.g., North America) this provides 27 discrete channels over which to hop.

Hop Sets provide a way of specifying the minimum channel spacing within the band and implicitly define the maximum number of hops. Hop Set A uses 307.5 kHz spacing and provides 80 channels. (Required for Modem selections 125kbps and 250kbps).

**Table 3-11. Selected Modem Modes**

Hop Set / Channels	Selected Modem Modes					
	125	250	500	1000	1000W	1250
<b>A</b>	80	80	27	20	17	14
<b>B</b>	0	0	27	20	15	14
<b>C</b>	0	0	26	20	16	13
<b>D</b>	0	0	0	20	16	13
<b>E</b>	0	0	0	0	16	13
<b>F</b>	0	0	0	0	0	13

See “APPENDIX F – NX915 Module Frequencies” on Page 418 for a chart listing RF channels/frequencies in each hop set, as they apply to each modem selection.

Other items of interest for tuning configuration include Modem Mode (125kbps, 250kbps, 500kbps, etc.) and dwell time. For remotes, setting modem mode to “auto” allows remotes to automatically follow the configuration of the AP. Setting the remote to use a specific modem trades faster sync times for system flexibility. Dwell time determines how frequently the radio switches channels. Longer dwell times are more efficient for data transport and provide higher throughput; but smaller dwell times provide faster synchronization and are more robust in weak signal environments or in the presence of interferers.



For the advanced user, the module supports configuring more items including:

- **Data Retries** - Number of times to retry unicast data before declaring NACK.
- **Fragment Threshold** - Fragmentation threshold
- **Lna State** - Controls the low noise amplifier
- **Mcast Repeat** - Number of times to repeat downstream broadcast and multicast data.
- **Propagation Delay** - Correction for the propagation delay of the RF signal.
- **Stale Packet Timeout** - If the MAC is unable to transmit a packet in this time, it will drop the packet.

In general, it is recommended that users start with the simplest configuration and then make parameter changes as necessary to meet specific needs.

---

**NOTE** Frequency blocking to meet country specific regulatory requirements may be configured for by the factory to disallow operation. These settings can NOT be changed or modified by the user. See the table below:

---

**Table 3-12. Country Limitations Example**

Country	Limitation
Brazil	Operate only in the band 902-907 and 915-928 MHz
Australia/Chile	Operate only in the band 915-928 MHz
New Zealand	Operate only in the band 921-928 MHz

**Table 3-13. NxRadio Interface LED Descriptions**

LED - NIC2	State	Description
NxRadio Interface	Off	Interface disabled
Access Point Mode	Blink Red	NIC Initialization
	Solid Red	No Remotes connected
	Solid Green	Linked with at least 1 Remote
Remote Mode	Blink Red	NIC Initialization / Not linked to an Access Point
	Solid Green	Linked with Access Point

### Important Notes and Information Regarding LQI

LQI is dependent on the modulation format and should be used as a relative measurement of the link quality. A low LQI value indicates a better link quality than a high value. Algorithmically, using GFSK modulation, the transceiver calculates the value by measuring the frequency of each "bit" and compares it with the expected frequency based on the channel frequency and the deviation and the measured frequency offset.

- LQI is a metric of the quality of the received signal. It is a dynamic value that is computed only when data is received on the RF interface, and should be refreshed accordingly.
- Unlike RSSI which simply measures signal strength, LQI is only a measurement of the "correctness" of this signal. (This means how easily the received signal can be correctly demodulated.)
- In general the lower the LQI the better the quality.
- LQI should be used as a "relative" measurement. Precision is fairly loose and subject to variation from radio to radio and modulation format.





- For each modem (125,250,500...) LQI means something different because each modulation has varying receive bandwidths which can affect LQI calculations.

The following table can be used as a reference to quickly check the LQI reading and determine if it's good or not, and whether you should move to the next modem.

For example: Running Modem 1000 and the LQI reads 9, change to Modem 500. LQI then reads 16, change to Modem 250 and so forth.

**Table 3-14. LQI Reference Table**

LQI / Modem	125 kbps	250 kbps	500 kbps	1000 kbps	1000W kbps	1250 kbps
Pristine	0 - 8	0 - 16	0 - 8	0 - 4	0 - 1	0 - 1
Usable	9 - 14	17 - 21	9 - 14	5 - 6	2 - 3	2 - 3
Sensitivity (dBm) based on $1 \times 10^{-6}$ @ XXX kbps	-105	-103	-99	-95	-95	-95

Again, the LQI on modem's 1000W and 1250 are usually low. Display of an LQI value indicates a signal is present. Due to the Receiver's wide bandwidth in 1000/1000W/1250 Modems, the dynamic range is lower which typically resolves on a low LQI.

For the remaining modems, "Pristine" means in an absolutely perfect signal environment the best LQI will be less than or equal to the number in the table.

"Usable" means the signal quality is good and the radio should be able to demodulate correctly, however if LQI averages are approaching this limit then errors would be expected. Ideally average LQI should fall somewhere in between the two values shown for each modem.

Lastly, keep in mind this is a "relative" measurement. Please do not make any hard decisions based on this metric. Systems (obviously) are not all the same and optimizing the system may take a little configuring based on Noise Floor/Data Type/Data Volume...

An LQI of 255 is reported (on a given channel/s) during the setup sequence and might also be reported after the remote unit is "associated" with the AP. This does not necessarily imply poor RF conditions; only that no user traffic has been received by the remote from the AP on that specific channel.

As mentioned above since the LQI is a dynamic value that varies upon the environment and is only updated when data is received on the RF interface. It is recommended that to obtain a "good" LQI reading the user enable some traffic to/from the RF interface (where the LQI is being read). Example: If at a remote site, ping the AP and refresh LQI readings at the remote to get most updated LQI reading.

Another note on Modems and distance. The lower the kbps the further the units may be separated (lower the sensitivity). A 125kbps modem can reach out the farthest and the 1250kbps Modem would be the shortest. The Orbit will support up to 8 Hop Store-and-Forward to extend these distances (although Latency must be considered with each additional hop).

## Adaptive Data Rate

The adaptive data rate mode allows the uplink traffic to adjust which modem is used on a per remote basis and also works in Store and Forward networks. The mode selection allows the modem to vary over two ranges. It can vary over either 125 kbps to 250 kbps for FHSS operation or 500 kbps to 1250 kbps for DTS operation. When a remote's RSSI is stronger than the ADR threshold it will attempt to transmit with a faster modem. The downstream traffic is only sent at the lower data rate, either 125 kbps or 500kbps depending on the mode.



The primary use case for this feature is if an AP has some remotes that are close to the AP and could support a higher data rate and some farther away that can only support a lower data rate. This mode allows the close remotes to take advantage of the higher data rate for the uplink, when otherwise the whole network would have had to be run at the lower data rate. This feature will not give the optimal data rates if all remotes can support the higher data rate, because all downlink traffic will be sent at a lower data rate.

## Security

Setting the security mode to EAP or PSK will enable device authentication. When enabled, the remotes will authenticate with the AP (PSK) or a backend RADIUS server (EAP) before they are allowed to pass data on the network. The authentication protocol is compliant with IEEE 802.1X. If device authentication is enabled, over the air data encryption can also be enabled. This ensures all over the air traffic is protected. When encryption is enabled, the device must occasionally rotate the encryption keys. This rotation is logged in the event log with event type nx\_auth. These events can be suppressed in the event log configuration to prevent them from filling the event log. See section 3.6.2 for instruction on controlling the event log.

## Configuring

### AP Mode

#### Basic configuration with defaults

Navigate to: *Interfaces / NxRadio* ---> *Basic Config / Nx Radio*

**NxRadio Interface** ↻

Status Basic Config Advanced Config

▸ General

▾ NX Radio

**Nx Config**

- Modem Mode: 500kbps
- Device Mode: access-point
- Network Name: My Network
- Data Compression: none
- Header Compression:
- Power: 21
- Dwell Time: 10
- Beacon Interval: 150
- Hop Set: a

**Figure 3-42. ISM 900 (NX) Configuration Settings**

- **Modem Mode** - Controls the target throughput of the radio and attached remotes
  - 125kbps - Theoretical throughput of 125 kbps



- 250kbps - Theoretical throughput of 250 kbps
- 500kbps - Theoretical throughput of 500 kbps (DEFAULT)
- 1000kbps - Theoretical throughput of 1000 kbps with narrow bandwidth
- 1000Wkbps - Theoretical throughput of 1000 kbps with higher sensitivity
- 1250kbps - Theoretical throughput of 1250 kbps
- **Device Mode** - Sets the role the radio will assume in the network.
  - Remote (DEFAULT)
  - Access Point
  - Store and Forward
- **Network Name** - The name of the network. Used to control what networks is connected to. Valid values: 1 to 31 letters (DEFAULT is mds-nx). The network name string is used to identify the logical network the device as a member of a network. If the network name does not match, the device will log an event, to identify network name collisions.
- **Data Compression** – Over the air compression
  - lzo - Compresses the over the air traffic with the LZO algorithm
  - none - No data compression (DEFAULT)
- **Header Compression** – Disabled by DEFAULT. Enable/disable over the air robust header compression. This feature compresses IP headers to improve system performance, and is most useful in applications that rely on IP packets with small payloads, such as terminal server operations or MODBUS polling. This setting must match on each radio (Remote and AP).
- **Power** - The transmit power of the radio: Valid values: 20 - 30 dBm – DEFAULT is 30dBm
- **Dwell Time** - Time spent on a channel, Valid values: 10 - 400 ms - DEFAULT is 50ms
- **Beacon Interval** - The time interval that the AP will send beacons, the smaller the value the faster remotes will associate, the larger the value less over the air time is taken up by beacons and can be used for data. Valid values: 10 - 400 ms – DEFAULT = 150ms
- **Hop Set** - The hop set of the radio - DEFAULT “A”
  - A – F - refer to APPENDIX I – Country Specific Information
  - Auto - for Remotes - this causes the radio to hunt for an AP, trying different modem modes. This can take a significant amount of time to sync and begin to pass data.

---

**NOTE** Remember to click on the **Save** button when finished.

---

Security	
Security Mode	eap
Encryption	aes128-ccm
Radius Server	
Rekey Interval	180 minutes

**Figure 3-43. ISM 900 (NX) EAP Security Settings**



**Security**

- Security Mode: psk
- Encryption: aes128-ccm
- Passphrase: [redacted]
- Rekey Interval: 180

**Figure 3-44. ISM 900 (NX) PSK Security Settings**

- **Security Mode** - The type of authentication to perform
  - none - Provide no device authentication or data privacy (DEFAULT)
  - psk - Use pre-shared key authentication protocol
  - eap - Use Encapsulated Authentication Protocol - will change the fields displayed and give the user the ability to enter radius info on the AP and certificate info on the remote.
- **Encryption** - The type of encryption to perform
  - none - No data privacy (DEFAULT)
  - aes128-ccm - Protect data with 128-bit AES encryption using CCM mode
  - aes256-ccm - Protect data with 256-bit AES encryption using CCM mode
- **Passphrase** - The passphrase used in PSK mode, 8 to 64 letters. (DEFAULT=blank)
- **Radius Server** – A reference to the RADIUS server configuration configured through the System – RADIUS side menu item (section 3.7.4).
- **Rekey Interval** – The session key for an active secure link changes at a regular basis. You may increase the length of the rekey interval in order to reduce overhead caused by the rekeying communications between radios on a narrowband channel. Valid values:
  - 0 – Rekeying will not be time-based, but will instead occur every one million packets.
  - 30-525600 minutes, DEFAULT 180



## NxRadio Interface

Status	Basic Config	Advanced Config
▼ Advanced NX Config		
ⓘ Lna State	high-sensitivity	▼
ⓘ Avoided Frequencies	Add an entry ...	
ⓘ Stale Packet Timeout	1500	
ⓘ Propagation Delay	60miles	▼
ⓘ Mcast Repeat	3	
ⓘ Data Retries	3	
ⓘ Fragment Threshold	0	
ⓘ Remote Age Time	180	
ⓘ Endpoint Age Time	60	
ⓘ Allow Retransmit	<input checked="" type="checkbox"/>	
ⓘ Arp Cache	<input type="checkbox"/>	
ⓘ Adr Mode	none	▼
ⓘ Adr Threshold	-70	
ⓘ Encryption Protocol	2.0	

**Figure 3-45. ISM 900 (NX) AP Advanced Settings**

- **Lna State** – The *High Sensitivity* setting will amplify the incoming signal and increase the chance of detecting weak signals. This is the default mode for the LNA. In a high noise environment, such as at main tower where an AP might be located, it can help to turn the LNA to *High Immunity*, which disables the LNA amplification. This means the radio will not be trying extra to amplify the collocated RF noise. It will be more difficult to detect weak signals, if at all, but enhance the probability to detect the stronger ones.
  - High Sensitivity – set when operating in a low noise environment with minimal radio interference (DEFAULT)
  - High Immunity - set when operating in an environment with radio interference
- **Avoided Frequencies** - Frequencies that are not included in the hop pattern. Decimal MHz in the form of “###”, “###.#”, “###.##”, “###.###”, “###.####”, “###.#####”. A range is required, with the values separated by a hyphen, with or without spaces on either side. For example “902.2-910” to block 8MHz on the lower portion of the band from 902-910 MHz. To block a single channel enter a value like “915.615-915.615”. This ensures blocking the specified frequency but depending on hop settings, may block other channels as well.



- **Stale Packet Timeout** - If the MAC is unable to transmit a packet in this time, it will drop the packet. Milliseconds, DEFAULT= 1500, range from 0 to 65535.
- **Propagation Delay** - Correction for the propagation delay of the RF signal. Enumeration of 20, 40, or 60 mile speed-of- light delay. DEFAULT = 40
- **Mcast Repeat** – Multicast repeat number - Number of times to repeat downstream broadcast and multicast data. DEFAULT = 3, range from 0 to 255.
- **Data Retries** - Number of times to retry unicast data before declaring NACK. Valid values: 0—15, DEFAULT = 3.
- **Fragment Threshold** – – This parameter controls the NIC’s over the air fragmentation. It is transparent to all network traffic and is independent of any IP fragmentation. Any packet larger than the threshold will be broken up into packets up to the threshold size. Valid values: 0, 50—1500 Bytes, 0 is disabled. DEFAULT = 0.
- **Remote Age Time** – Length of time, in seconds, of inactivity of the device before it is disconnected. Valid values: 180-4294967295, DEFAULT = 600
- **Endpoint Age Time**- Length of time in seconds if inactivity on this endpoint before it is removed from the database. DEFAULT = 300. Range of 0 to 4294967295
- **Allow Retransmit** – All traffic from the remotes is sent to the AP. When enabled the AP will retransmit traffic from one remote to another based on the MAC address. It will also resend any remotes broadcast traffic to all other remotes.
- **ARP Cache** – Disabled by DEFAULT. When enabled, the radio will respond to ARP requests intended for other network devices with known addresses. It will not forward the ARP to the intended device
- **ADR Mode** – Adaptive data rate mode controls whether the NIC will attempt to use different modem speeds for different remotes. All downstream traffic uses the lowest rate; only upstream traffic can use the variable rate. ADR setting is automatically learned by remotes, but remotes modem must be set to Auto, or 125 for 125-250kbps, or 500 for 500-1250 kbps operation.
  - 125-250kbps – ADR will attempt to use the FHSS modems (125kbps and 250kbps) when trying to determine the best modem for the remote.
  - 500-1250kbps – ADR will use the DTS modems (500kbps, 1000kbps, 1000W kbps, and 1250 kbps) when attempting to determine the optimal rate.
  - none – ADR is not used and the static modem setting in nx-config is used for the modem. (Default)
- **ADR Threshold** – The threshold is an RSSI threshold. If the received signal is stronger than the threshold the NIC will attempt to use a faster modem. ADR Threshold must be set for each radio (Remotes and AP). This is advantageous in that you can run the majority of the network in ADR mode, but if a particular remote has strong RSSI but difficult channel conditions you can effectively disable ADR on that specific remote by setting the ADR threshold artificially low.
- **Encryption Protocol** – Encryption Protocol 2.0 provides the highest level of over the air encryption security with a strong encryption key, but is not compatible with MCR-900 radios running firmware earlier than 3.1.0. Encryption Protocol 1.0 provides compatibility with older firmware by using the strong key when talking to units with firmware 3.1.0 and later, and a less strong key when talking to units with firmware earlier than 3.1.0. DEFAULT 2.0. For more information, refer to Product Bulletin PB15001\_A, *MCR-900 Encryption Issue Resolution*, available at <http://www.gemds.com>.



General

Description

Enabled

Vlan Mode

**Figure 3-46. ISM 900 (NX) VLAN Setting**

- **Description** – User description of the NxRadio.
- **Enabled** – Enable the NxRadio. DEFAULT = ENABLED.
- **Vlan Mode** - VLAN configuration
  - None
  - Access - Only one VLAN can be configured on an access interface; traffic carried for only one VLAN.
  - Trunk - Two or more VLANs configured on a trunk port; several VLANs can be carried simultaneously.

## Remote Mode

### Basic configuration with defaults

The advanced configuration on an NX915 module operating as a Remote, shares the same configuration for LNA state, stale packets timeout and data retries as an Access Point. Using the default value of 0 (zero) for the NIC and Gateway Identifiers configure the module to automatically obtain a path in the network. This is particularly useful in a network that contains Store-and-Forward devices.

Navigate to: *Interfaces / NxRadio* ---> *Basic Config / Nx Radio*

## NxRadio Interface

Status Basic Config Advanced Config

General

NX Radio

**Nx Config**

Modem Mode

Device Mode

Network Name

Data Compression

Header Compression

Power

**Figure 3-47. ISM 900 (NX) Remote Configuration**

- **Modem Mode** - Controls the target throughput of the radio.
  - 125kbps - Theoretical throughput of 125 kbps
  - 250kbps - Theoretical throughput of 250 kbps



- 500kbps - Theoretical throughput of 500 kbps (DEFAULT)
- 1000kbps - Theoretical throughput of 1000 kbps with narrow bandwidth
- 1000Wkbps - Theoretical throughput of 1000 kbps with higher sensitivity
- 1250kbps - Theoretical throughput of 1250 kbps
- Auto - While the AP must pick a fixed modem, in this mode the remote will scan through all modems and find the one with the strongest signal. Each modem scan can take a few minutes which means worst case it could take up to 5 modem changes before finding the correct modem. The unit will continue to scan until it connects with an AP.
- **Device Mode** - Sets the role the radio will assume in the network.
  - Remote (DEFAULT)
  - Access Point
  - Store and Forward
- **Network Name** - The name of the network. Used to control what networks is connected to. Valid values: 1 to 31 letters (DEFAULT = mds-nx). The network name string is used to identify the logical network the device as a member of a network. If the network name does not match, the device will log an event, to identify network name collisions.
- **Data Compression** – Over the air compression
  - lzo - Compresses the over the air traffic with the LZO algorithm
  - none - No data compression (DEFAULT)
- **Header Compression** – Disabled by DEFAULT. Enable/disable over the air robust header compression. This feature compresses IP headers to improve system performance, and is most useful in applications that rely on IP packets with small payloads, such as terminal server operations or MODBUS polling. This setting must match on each radio (Remote and AP).
- **Power** - The transmit power of the radio. Valid values are: 20—30 dBm –DEFAULT =30dBm

**Security**

Security Mode: eap

Encryption: aes128-ccm

EAP Mode: eap-tls

**PKI**

Certificate ID: [ ] ...

Key ID: [ ] ...

CA Certificate ID: [ ] ...

Figure 3-48. ISM 900 (NX) Remote EAP Security Configuration





The image shows a configuration panel titled "Security" with three rows. Each row has an information icon (i) on the left. The first row is "Security Mode" with a dropdown menu showing "psk". The second row is "Encryption" with a dropdown menu showing "aes128-ccm". The third row is "Passphrase" with a text input field containing 16 dots.

Figure 3-49. ISM 900 (NX) PSK Remote Security Configuration

- **Security Mode** - The type of authentication to perform
  - none - Provide no device authentication or data privacy
  - psk - Use pre-shared key authentication protocol
  - eap - Use Encapsulated Authentication Protocol
- **Encryption** - The type of encryption to perform
  - none - No data privacy (DEFAULT)
  - aes128-ccm - Protect data with 128-bit AES encryption using CCM mode
  - aes256-ccm - Protect data with 256-bit AES encryption using CCM mode
- **Passphrase** - The passphrase used in PSK mode. Valid Values are: 8 to 64 letters. (DEFAULT=blank)
- **Certificate ID, Key ID, CA Certificate ID** – Reference to the remotes certificate material loaded through the Certificate Management side menu (section 3.9).

## NxRadio Interface

The image shows a configuration panel with three tabs: "Status", "Basic Config", and "Advanced Config". The "Advanced Config" tab is selected. Below the tabs is a blue header "Advanced NX Config" with a dropdown arrow. The main area contains several rows, each with an information icon (i) on the left. The rows are: "Lna State" with a dropdown menu showing "high-sensitivity"; "Stale Packet Timeout" with a text input field showing "1500"; "Data Retries" with a text input field showing "3"; "Nic ID" with a text input field showing "0"; "Gateway ID" with a text input field showing "0"; "Arp Cache" with a checkbox that is unchecked; "Adr Mode" with a dropdown menu showing "none"; "Adr Threshold" with a text input field showing "-70"; and "Encryption Protocol" with a dropdown menu showing "1.0".

Figure 3-50. ISM 900 (NX) Remote Advanced Configuration



- **Lna State** – Low Noise Amplifier in the *High Sensitivity* setting will amplify the incoming signal and increase the chance of detecting weak signals. This is the default mode for the LNA. In a high noise environment, such as at main tower where an AP might be located, it can help to turn the LNA to *High Immunity*, which disables the LNA amplification. This means the radio will not be trying extra to amplify the collocated RF noise. It will be more difficult to detect weak signals, if at all, but enhance the probability to detect the stronger ones.
  - High Sensitivity – set when operating in a low noise environment with minimal radio interference
  - High Immunity - set when operating in an environment with radio interference
- **Stale Packet Timeout** - If the MAC is unable to transmit a packet in this time, it will drop the packet. Milliseconds, DEFAULT = 1500, range from 0 to 65535.
- **Data Retries** - Number of times to retry unicast data before declaring NACK. Valid values: 0—15, DEFAULT = 3.
- **NIC ID – ADVANCED SETTING - DO NOT CHANGE** - Manual overrides of the NIC identifier: DEFAULT = 0, means auto, not manual. Range of 0 or 400-500
- **Gateway ID - ADVANCED SETTING - DO NOT CHANGE** - Manual overrides of the NIC's gateway identifier: DEFAULT = 0, means auto, not manual Range of 0 or 65535.
- **ARP Cache** – Disabled by DEFAULT. When enabled, the radio will respond to ARP requests intended for other network devices with known addresses. It will not forward the ARP to the intended device.
- **ADR Mode** – Adaptive data rate mode controls whether the NIC will attempt to use different modem speeds for different remotes. All downstream traffic uses the lowest rate; only upstream traffic can use the variable rate. ADR setting is automatically learned by remotes, but remotes modem must be set to Auto, or 125 for 125-250kbps, or 500 for 500-1250 kbps operation.
  - 125-250kbps – ADR will attempt to use the FHSS modems (125kbps and 250kbps) when trying to determine the best modem for the remote.
  - 500-1250kbps – ADR will use the DTS modems (500kbps, 1000kbps, 1000W kbps, and 1250 kbps) when attempting to determine the optimal rate.
  - none – ADR is not used and the static modem setting in nx-config is used for the modem.
- **ADR Threshold** – The threshold is an RSSI threshold. If the received signal is stronger than the threshold the NIC will attempt to use a faster modem. ADR Threshold must be set for each radio (Remotes and AP). This is advantageous in that you can run the majority of the network in ADR mode, but if a particular remote has strong RSSI but difficult channel conditions, you can effectively disable ADR on that specific remote by setting the ADR threshold artificially low. DEFAULT = -70, range from -127 to 0.
- **Encryption Protocol** – Encryption Protocol 2.0 provides the highest level of over the air encryption security with a strong encryption key, but is not compatible with MCR-900 radios running firmware earlier than 3.1.0. Encryption Protocol 1.0 provides compatibility with older firmware by using the strong key when talking to units with firmware 3.1.0 and later, and a less strong key when talking to units with firmware earlier than 3.1.0. DEFAULT 2.0. For more information, refer to Product Bulletin PB15001\_A, *MCR-900 Encryption Issue Resolution*, available at <http://www.gemds.com>

## Store and Forward Mode

### Basic configuration with defaults

The advanced configuration on an NX915 module operating as a Store-and-Forward device, shares the same configuration as a Remote.

### *Interfaces / NxRadio ---> Basic Config / Nx Radio*



## NxRadio Interface

Status Basic Config **Advanced Config**

▸ General  
▾ NX Radio

**Nx Config**

Modem Mode	500kbps
Device Mode	store-and-forward
Network Name	My Network
Data Compression	none
Header Compression	<input type="checkbox"/>
Power	21
Beacon Interval	150

**Figure 3-51. ISM 900 (NX) S&F Configuration**

- **Modem Mode** - Controls the target throughput of the radio
  - 125kbps - Theoretical throughput of 125 kbps
  - 250kbps - Theoretical throughput of 250 kbps
  - 500kbps - Theoretical throughput of 500 kbps (DEFAULT)
  - 1000kbps - Theoretical throughput of 1000 kbps with narrow bandwidth
  - 1000Wkbps - Theoretical throughput of 1000 kbps with higher sensitivity
  - 1250kbps - Theoretical throughput of 1250 kbps
  - Auto - While the AP must pick a fixed modem, in this mode the remote can walk all modems and find the one with the strongest signal.
- **Device Mode** - Sets the role the radio will assume in the network.
  - Remote (DEFAULT)
  - Access Point
  - Store and Forward
- **Network Name** - The name of the network. Used to control what networks the radio connects to. Valid values: 1 to 31 letters (DEFAULT is mds-nx). The network name string is used to identify the logical network that the device should join. If the network name does not match, the device will log an event to identify network name collisions.
- **Data Compression** – Over the air compression
  - lzo - Compresses the over the air traffic with the LZO algorithm
  - none - No data compression (DEFAULT)
- **Header Compression** – Disabled by DEFAULT. Enable/disable over the air robust header compression. This feature compresses IP headers to improve system performance, and is most useful in applications that rely on IP packets with small payloads, such as terminal server operations or MODBUS polling. This setting must match on each radio (Remote and AP).



- **Power** - The transmit power of the radio. Valid values are: 20-30 dBm – (DEFAULT - 30dBm)
- **Dwell Time** - Time spent on a channel. Valid values are: 10-400 ms - (DEFAULT - 50ms)
- **Beacon Interval** - Time spent on a channel. Valid values are: 10-400 ms -(DEFAULT - 50ms)

The screenshot shows the 'Security' configuration page for EAP mode. It includes three dropdown menus: 'Security Mode' set to 'eap', 'Encryption' set to 'aes128-ccm', and 'EAP Mode' set to 'eap-tls'. Below these is a 'PKI' section with three input fields: 'Certificate ID', 'Key ID', and 'CA Certificate ID', each with a dropdown arrow to its right.

Figure 3-52. ISM 900 (NX) S&F PSK Security Configuration

The screenshot shows the 'Security' configuration page for PSK mode. It includes three dropdown menus: 'Security Mode' set to 'psk', 'Encryption' set to 'aes128-ccm', and 'Passphrase' which is a text input field containing 16 dots.

Figure 3-53. ISM 900 (NX) S&F PSK Security Configuration

- **Security Mode** - The type of authentication to perform
  - none - Provide no device authentication or data privacy (DEFAULT)
  - psk - Use pre-shared key authentication protocol
  - eap - Use Encapsulated Authentication Protocol
- **Encryption** - The type of encryption to perform
  - none - No data privacy
  - aes128-ccm - Protect data with 128-bit AES encryption using CCM mode
  - aes256-ccm - Protect data with 256-bit AES encryption using CCM mode
- **Passphrase** - The passphrase used in PSK mode 8 to 64 letters.
- **Certificate ID, Key ID, CA Certificate ID** – Reference to the remotes certificate material loaded through the Certificate Management side menu (section 3.9).



## NxRadio Interface

Status	Basic Config	Advanced Config
▼ Advanced NX Config		
ⓘ Lna State		high-sensitivity ▼
ⓘ Avoided Frequencies		Add an entry ...
ⓘ Stale Packet Timeout		1500
ⓘ Propagation Delay		60miles ▼
ⓘ Mcast Repeat		3
ⓘ Data Retries		3
ⓘ Fragment Threshold		0
ⓘ Remote Age Time		180
ⓘ Endpoint Age Time		60
ⓘ Allow Retransmit		<input checked="" type="checkbox"/>
ⓘ Arp Cache		<input type="checkbox"/>
ⓘ Adr Mode		none ▼
ⓘ Adr Threshold		-70
ⓘ Encryption Protocol		2.0 ▼

**Figure 3-54. ISM 900 (NX) S&F Advanced Configuration**

- **Lna State** – The *High Sensitivity* setting will amplify the incoming signal and increase the chance of detecting weak signals. This is the default mode for the LNA. In a high noise environment, such as at main tower where an AP might be located, it can help to turn the LNA to High Immunity, which disables the LNA amplification. This means the radio will not be trying extra to amplify the collocated RF noise. It will be more difficult to detect weak signals, if at all, but enhance the probability to detect the stronger ones.
  - High Sensitivity – set when operating in a low noise environment with minimal radio interference
  - High Immunity - set when operating in with radio interference
- **Stale Packet Timeout** - If the MAC is unable to transmit a packet in this time, it will drop the packet. Milliseconds, DEFAULT = 1500, range from 0 to 65535.
- **Data Retries** - Number of times to retry unicast data before declaring NACK. Valid values: 0—15, DEFAULT = 3.
- **NIC ID – ADVANCED SETTING - DO NOT CHANGE** - Manual overrides of the NIC identifier.



- **Gateway ID - ADVANCED SETTING - DO NOT CHANGE** - Manual overrides of the NIC's gateway identifier.
- **ARP Cache** – Disabled by DEFAULT. When enabled, the radio will respond to ARP requests intended for other network devices with known addresses. It will not forward the ARP to the intended device.
- **ADR Mode** – Adaptive data rate mode controls whether the NIC will attempt to use different modem speeds for different remotes. All downstream traffic uses the lowest rate; only upstream traffic can use the variable rate. ADR setting is automatically learned by remotes, but remotes modem must be set to Auto, or 125 for 125-250kbps, or 500 for 500-1250 kbps operation.
  - 125-250kbps – ADR will attempt to use the FHSS modems (125kbps and 250kbps) when trying to determine the best modem for the remote.
  - 500-1250kbps – ADR will use the DTS modems (500kbps, 1000kbps, 1000W kbps, and 1250 kbps) when attempting to determine the optimal rate.
  - none – ADR is not used and the static modem setting in nx-config is used for the modem.
- **ADR Threshold** – The threshold is an RSSI threshold. If the received signal is stronger than the threshold the NIC will attempt to use a faster modem. ADR Threshold must be set for each radio (Remotes and AP). This is advantageous in that you can run the majority of the network in ADR mode, but if a particular remote has strong RSSI but difficult channel conditions, you can effectively disable ADR on that specific remote by setting the ADR threshold artificially low. DEFAULT = -70, range from -127 to 0.
- **Encryption Protocol** – Encryption Protocol 2.0 provides the highest level of over the air encryption security with a strong encryption key, but is not compatible with MCR-900 radios running firmware earlier than 3.1.0. Encryption Protocol 1.0 provides compatibility with older firmware by using the strong key when talking to units with firmware 3.1.0 and later, and a less strong key when talking to units with firmware earlier than 3.1.0. DEFAULT 2.0. For more information, refer to Product Bulletin PB15001\_A, *MCR-900 Encryption Issue Resolution*, available at <http://www.gemds.com>.

## Monitoring

### AP Status Monitoring:

General Interface information: *Interfaces / NxRadio ---> Status / General*

The screenshot shows the 'NxRadio Interface' configuration page with the 'Status' tab selected. Under the 'General' section, the following information is displayed:

Type*	nx	Refresh every <input type="text"/> seconds
Admin Status*	up	
Oper Status*	up	
If Index*	4	
Phys Address	00:06:3d:07:67:f9	

**Figure 3-55. ISM 900 (NX) AP Status**

- **Type** - The type of the interface
- **Admin Status** - The desired state of the interface.
- **Oper Status** - The current operational state of the interface.
- **If Index** - The ifIndex value for the ifEntry represented by this interface. Valid values are: 1—2147483647



- **Phys Address**- The interface's address at its protocol sub-layer. For example, for an 802.x interface, this object normally contains a MAC address. The interface's media-specific modules must define the bit and byte ordering and the format of the value of this object. For interfaces that do not have such an address (e.g., a serial line), this node is not present.

### Statistics - A collection of interface-related statistics objects.

General	
Statistics	
Discontinuity Time*	Wed, 26 Nov 2014 14:41:12 GMT
In Octets	8475798
In Unicast Pkts	10169
In Broadcast Pkts	
In Multicast Pkts	0
In Discards	0
In Errors	0
In Unknown Protos	
Out Octets	1383329
Out Unicast Pkts	10168
Out Broadcast Pkts	
Out Multicast Pkts	
Out Discards	269
Out Errors	38

Refresh every  seconds

Figure 3-56. ISM 900 (NX) AP Statistics

- **Discontinuity Time** - The time on the most recent occasion at which one or more of this interface's counters suffered a discontinuity.
- **In Octets** - The total number of octets received on the interface, including framing characters.
- **In Unicast Pkts** - The number of packets, delivered by this sub-layer to a higher (sub-)layer, which were not addressed to a multicast or broadcast address at this sub-layer.
- **In Broadcast Pkts** - The number of packets, delivered by this sub-layer to a higher (sub-)layer, which were addressed to a broadcast address at this sub-layer.
- **In Multicast Pkts** - The number of packets, delivered by this sub-layer to a higher (sub-)layer, which were addressed to a multicast address at this sub-layer.
- **In Discards** - The number of inbound packets which were chosen to be discarded even though no errors had been detected to prevent their being deliverable to a higher-layer protocol. One possible reason for discarding such a packet could be to free up buffer space.
- **In Errors** - For packet-oriented interfaces, the number of inbound packets that contained errors preventing them from being deliverable to a higher-layer protocol.
- **In Unknown Protos** - For packet-oriented interfaces, the number of packets received via the interface which were discarded because of an unknown or unsupported protocol.
- **Out Octets** - The total number of octets transmitted out of the interface, including framing characters.
- **Out Unicast Pkts** - The total number of packets that higher-level protocols requested be transmitted, and which were not addressed to a multicast or broadcast address at this sub-layer, including those that were discarded or not sent.



- **Out Broadcast Pkts** - The total number of packets that higher-level protocols requested be transmitted, and which were addressed to a broadcast address at this sub-layer, including those that were discarded or not sent.
- **Out Multicast Pkts** - The total number of packets that higher-level protocols requested be transmitted, and which were addressed to a multicast address at this sub-layer, including those that were discarded or not sent.
- **Out Discards** - The number of outbound packets which were chosen to be discarded even though no errors had been detected to prevent their being transmitted.
- **Out Errors** - For packet-oriented interfaces, the number of outbound packets that could not be transmitted because of errors.

## NX Status Monitoring:

*Interfaces / NxRadio ---> Status / Nx Radio*

Nx Radio	
Init Status	complete
Current Device Mode	access-point
Current Modem	500kbps
Alarms	
Serial Number	2501772
Firmware Revision	0.6.0
Hardware ID	13
Hardware Revision	3
Temperature	48

**Figure 3-57. ISM 900 (NX) Status**

- **Init Status** - State of the NIC Initialization
  - Off - Not operating
  - Initializing - Powering on the NIC
  - Discovering - Determining the NIC address
  - Reprogramming - Programming the NIC firmware
  - Configuring - Configuring the NIC
  - Complete - Initialization complete
- **Current Device Mode** – Read-only display of the active mode the NxRadio is operating.
- **Current Modem** - The current operating modem
  - 125kbps - Theoretical throughput of 125 kbps
  - 250kbps - Theoretical throughput of 250 kbps
  - 500kbps - Theoretical throughput of 500 kbps (DEFAULT)
  - 1000kbps - Theoretical throughput of 1000 kbps with narrow bandwidth
  - 1000Wkbps - Theoretical throughput of 1000 kbps with higher sensitivity
  - 1250kbps - Theoretical throughput of 1250 kbps
- **Alarms** - The current NIC alarms:
  - frequency-not-programmed
  - authorization-fault





- synthesizer-out-of-lock
- a-to-d-fault
- voltage-refrequency-not-programmed
- authorization-fault
- synthesizer-out-of-lock
- a-to-d-fault
- voltage-regulator-fault-detected
- radio-not-calibrated
- dsp-download-fault
- flash-write-failure
- checksum-fault
- receiver-time-out
- transmitter-time-out
- alarm-test
- vswr-fault

---

**NOTE** If the antenna system does not provide a proper impedance match an alarm is generated that indicates “VSWR Fault”. This is an indication that the ratio of RF power out to power reflected is approaching a 4:1 ratio or higher - ideally this should be 1:1. This should be corrected to achieve optimal radio performance. It may be helpful to use an SWR test device to troubleshoot.

---

- unit-address-not-programmed
  - data-parity-error
  - data-framing-error
  - configuration-error
  - six-v-regulator-output
  - dc-input
  - rf-output-power
  - internal-temp
- **Serial Number** – Serial number of the installed NX radio.
  - **Firmware Revision** - NIC Firmware Revision 0 to 32 characters.
  - **Hardware ID** - The Hardware ID.
  - **Hardware Revision** - The Hardware Revision.
  - **Temperature** - The transceiver temperature in degrees C.

### Remote's AP Info (Remote and Store-And-Forward Mode ONLY):

Ap Info	
Ap Address	00:06:3d:07:67:f9
IP Address	10.10.10.142
Connected Time	585
Avg Rssi	-57
Avg Lqi	5

Figure 3-58. ISM 900 (NX) S&F AP Information



- **Ap Address** - MAC address of access point this device is linked to
- **Ip Address** - IP address of access point this device is linked to.
- **Connected Time** - Time elapsed in seconds since link established. Roll over after 4294967295 seconds
- **Avg Rssi** - Average received signal strength index in dBm and ignores the "quality" or "correctness" of the signal - Refer to Table 3-9. Modulation and Bandwidth Combinations for modem related RSSI information.
- **Avg Lqi** - Average Link Quality Index - This is a unit-less metric representing the quality of the latest signal decoded by the transceiver. Important Notes and Information Regarding LQI

## MAC Statistics

<b>Mac Stats</b>	
📌 Tx Success	12881
📌 Tx Fail	0
📌 Tx Queue Full	0
📌 Tx No Sync	1
📌 Tx No Assoc	0
📌 Tx Error	0
📌 Tx Retry	0
📌 Rx Success	12799
📌 Sync Check Error	1
📌 Sync Change	16

**Figure 3-59. ISM 900 (NX) MAC Statistics**

- **Tx Success** - Successful transmissions.
- **Tx Fail** - Failed transmissions, TTL expired or retry count exceeded.
- **Tx Queue Full** - Failed transmissions, MAC queue full.
- **Tx No Sync** - Number of packets dropped because the MAC is not synchronized
- **Tx No Assoc** - Packets dropped because the MAC is not associated
- **Tx Error** - Packets dropped for other reasons. Currently unused.
- **Tx Retry** - Re-transmission count due to previously unsuccessful transmission.
- **Rx Success** - Valid packet received.
- **Sync Check Error** - Lost synchronization.
- **Sync Change** - Synchronization changed or forced drop.

## Connections Status

In AP mode the “Connected Remotes” and “Endpoints” information will be displayed in addition to the Active Channel.

---

**NOTE** Clicking on the mac address in either connected remotes or endpoints will bring up more stats.

---

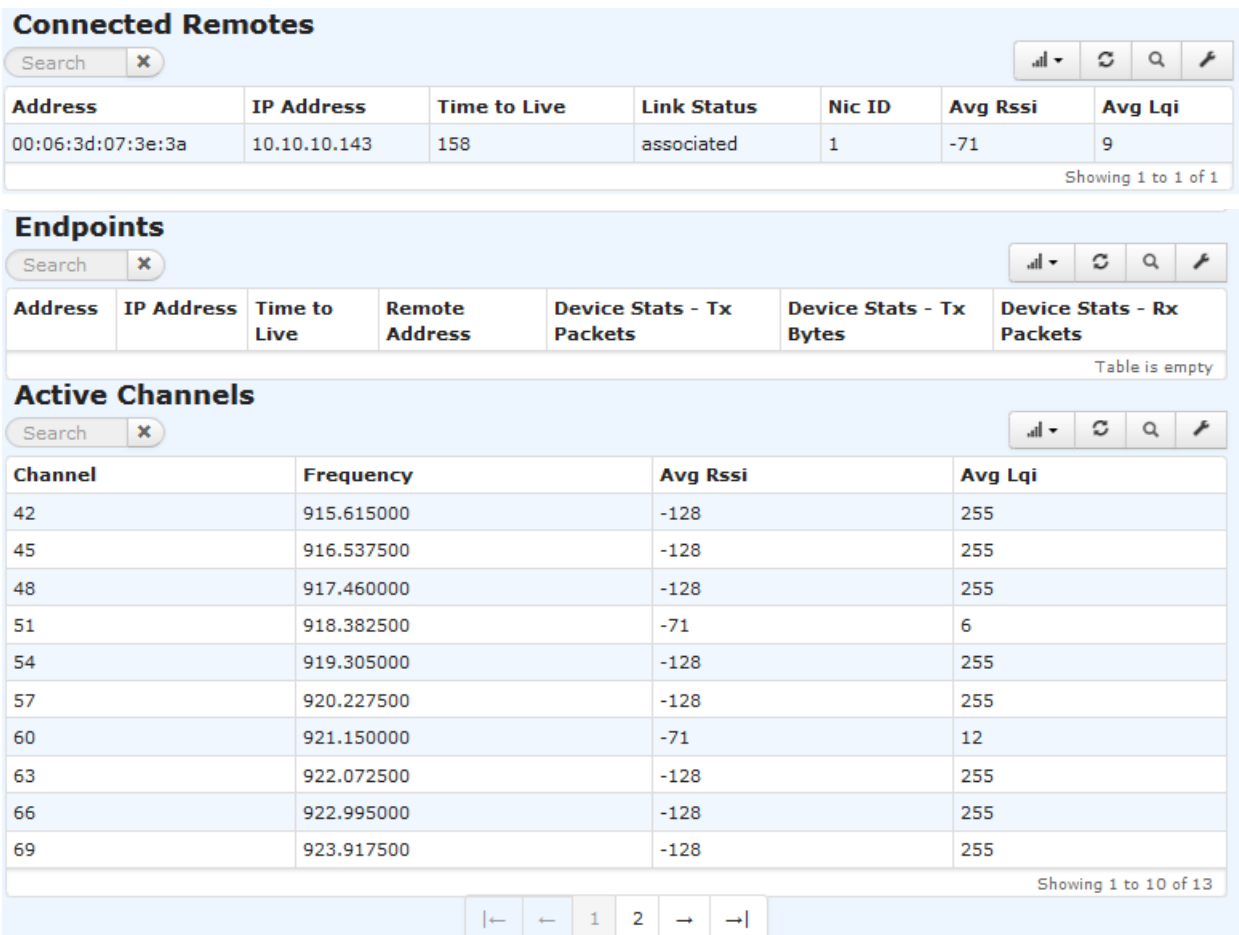


Figure 3-60. ISM 900 (NX) Connection Status

## CLI Configuration Examples

### AP Mode

On the next page, the example will display how to configure the NX915 module as an access point with the network name of 'MyNetwork' and default settings.

```

% set interfaces interface NxRadio nx-config device-mode access-point network-name
  MyNetwork
% show interfaces interface NxRadio nx-config | details
modem-mode          500kbps;
device-mode         access-point;
network-name        MyNetwork;
data-compression    none;
header compression  false;
power               30;
dwell-time          50;
beacon-interval     150;
hop-set             a;

security {
  security-mode      none;
  encryption         none;
}

```



```
advanced-config {  
  lna-state high-sensitivity;  
  stale-packet-timeout 1500;  
  propagation-delay 40miles;  
  mcast-repeat 3;  
  data-retries 3;  
  fragment-threshold 0;  
  remote-age-time 600;  
  endpoint-age-time 300;  
  allow-retransmit true;  
  arp-cache false;  
  adr-mode none;  
  adr-threshold -70;  
  encryption-protocol 2.0;  
}
```

## Security configuration

The default security mode, as shown above, is none.

The following configures the NX915 module to use data compression, pre-shared key authentication with the passphrase 'mypassphrase' and aes128-ccm encryption.

```
% set interfaces interface NxRadio nx-config data-compression lzo security encryption  
  aes128-ccm security-mode psk passphrase mypassphrase  
% show interfaces interface NxRadio nx-config | details  
modem-mode 500kbps;  
device-mode access-point;  
network-name MyNetwork;  
data-compression lzo;  
header compression false;  
power 30;  
dwell-time 50;  
beacon-interval 150;  
hop-set a;  
security {  
  security-mode psk;  
  encryption aes128-ccm;  
  passphrase mypassphrase;  
}  
advanced-config {  
  lna-state high-sensitivity;  
  stale-packet-timeout 1500;  
  propagation-delay 40miles;  
  mcast-repeat 3;  
  data-retries 3;  
  fragment-threshold 0;  
  remote-age-time 600;  
  endpoint-age-time 300;  
  allow-retransmit true;  
  arp-cache false;  
  adr-mode none;  
  adr-threshold -70;  
  encryption-protocol 2.0;
```



```
}

```

The following configures the NX915 module to use data compression, EAP authentication and aes128-ccm encryption. The radius server used by the EAP authentication is selected from a list of configured Radius servers.

```
% set interfaces interface NxRadio nx-config data-compression lzo security encryption
  aes128-ccm security-mode eap radius-server RADIUS_SERVER
% show interfaces interface NxRadio nx-config | details
modem-mode          500kbps;
device-mode         access-point;
network-name        MyNetwork;
data-compression    lzo;
header compression  false;
power               30;
dwell-time          50;
beacon-interval     150;
hop-set             a;
security {
  security-mode     eap;
  encryption        aes128-ccm;
  radius-server     RADIUS_SERVER;
}
advanced-config {
  lna-state          high-sensitivity;
  stale-packet-timeout 1500;
  propagation-delay  40miles;
  mcast-repeat       3;
  data-retries        3;
  fragment-threshold 0;
  remote-age-time     600;
  endpoint-age-time   300;
  allow-retransmit    true;
  arp-cache           false;
  adr-mode            none;
  adr-threshold       -70;
  encryption-protocol 2.0;
}

```

## Other configuration

The following will configure the NX915 module to operate at 20 dBm on hop-set b, with a beacon interval of 25 ms and a dwell time of 75 ms. It also setups several advanced configuration parameters to move the propagation delay to 60 miles, disabled the data retries and multicast/broadcast repeats. It configures the LNA to operate in a high immunity mode, fragments data frames to 50 bytes, set a stale packet timeout to 1250 ms and avoids operating in the band from 915 to 920 MHz.

```
% set interfaces interface NxRadio nx-config power 20 hop-set b beacon-interval 25 dwell-
  time 75 advanced-config propagation-delay 60miles data-retries 0 mcast-repeat 0 lna-state
  high-immunity fragment-threshold 50 stale-packet-timeout 1250 avoided-frequencies 915-
  920
% show interfaces interface NxRadio nx-config | details
modem-mode          500kbps;
device-mode         access-point;
network-name        MyNetwork;

```



```
data-compression      lzo;
header compression    false;
power                  20;
dwell-time            75;
beacon-interval       25;
hop-set                b;
security {
    security-mode      psk;
    encryption         aes128-ccm;
    passphrase         mypassphrase;
}
advanced-config {
    lna-state          high-immunity;
    avoided-frequencies [ 915-920 ];
    stale-packet-timeout 1250;
    propagation-delay   60miles;
    mcast-repeat        0;
    data-retries        0;
    fragment-threshold  50;
    remote-age-time     600;
    endpoint-age-time   300;
    allow-retransmit    true;
    arp-cache           false;
    adr-mode            none;
    adr-threshold       -70;
    encryption-protocol 2.0;
}
```

## Remote Mode

The following will configure the NX915 module as a Remote with the network name of 'MyNetwork' and default settings.

```
% set interfaces interface NxRadio nx-config device-mode remote network-name MyNetwork
% show interfaces interface NxRadio nx-config | details
modem-mode          500kbps;
device-mode         remote;
network-name        MyNetwork;
data-compression    none;
header-compression  false;
power               30;
security {
    security-mode    none;
    encryption       none;
}
advanced-config {
    lna-state        high-sensitivity;
    stale-packet-timeout 1500;
    data-retries     3;
    nic-id           0;
    gateway-id       0;
    arp-cache        false;
    adr-mode         none;
```



```
adr-threshold      -70;
encryption-protocol 2.0;
}
```

## Security Configuration

The default security mode, as shown above, is none. The following configures the NX915 module to use data compression, pre-shared key authentication with the passphrase “mypassphrase” and aes128-ccm encryption.

```
% set interfaces interface NxRadio nx-config data-compression lzo security encryption
aes128-ccm security-mode psk passphrase mypassphrase
% show interfaces interface NxRadio nx-config | details
modem-mode          500kbps;
device-mode         remote;
network-name        MyNetwork;
data-compression    lzo;
header-compression  false;
power               30;
security {
  security-mode     psk;
  encryption        aes128-ccm;
  passphrase        mypassphrase;
}
advanced-config {
  lna-state         high-sensitivity;
  stale-packet-timeout 1500;
  data-retries      3;
  nic-id            0;
  gateway-id        0;
  arp-cache         false;
  adr-mode          none;
  adr-threshold     -70;
  encryption-protocol 2.0;
}
```

The following configures the NX915 module to use data compression, EAP authentication and aes128-ccm encryption. The EAP mode currently supports only EAP-TLS. This requires configuring the appropriate PKI Certificates and Keys to use in the TLS authentication. This information is selected from the PKI configuration.

```
% set interfaces interface NxRadio nx-config data-compression lzo security encryption
aes128-ccm security-mode eap eap-mode eap-tls pki ca-cert-id CACert key-id DevicePrivKey
cert-id DevicePubCert
% show interfaces interface NxRadio nx-config | details
modem-mode          500kbps;
device-mode         remote;
network-name        MyNetwork;
data-compression    lzo;
header-compression  false;
power               30;
security {
  security-mode     eap;
  encryption        aes128-ccm;
  eap-mode          eap-tls;
}
```



```
    pki {
      cert-id          DevicePubCert;
      key-id           DevicePrivKey;
      ca-cert-id       CACert;
    }
  }
  advanced-config {
    lna-state          high-sensitivity;
    stale-packet-timeout 1500;
    data-retries       3;
    nic-id             0;
    gateway-id        0;
    arp-cache          false;
    adr-mode           none;
    adr-threshold      -70;
    encryption-protocol 2.0;
  }
```

## Other configuration

The advanced configuration on an NX915 module operating as a Remote, shares the same configuration for LNA stat, stale packets timeout and data retries as an Access Point. The NIC and Gateway Identifier are for use in manually configuring link paths a station will use in the network. The default value of 0 for the identifiers configured the module to automatically obtain a path in the network. This is particularly useful in a network that contains Store-and-Forward devices.

## Store-and-Forward Mode

### Basic configuration with defaults

The following will configure the NX915 module as a Store-and-Forward (SAF) device with the network name of “MyNetwork” and default settings.

```
% set interfaces interface NxRadio nx-config device-mode store-and-forward network-name
MyNetwork
% show interfaces interface NxRadio nx-config | details
modem-mode          500kbps;
device-mode         store-and-forward;
network-name        MyNetwork;
data-compression    none;
header-compression  false;
power               30;
security {
  security-mode     none;
  encryption        none;
}
advanced-config {
  lna-state          high-sensitivity;
  stale-packet-timeout 1500;
  propagation-delay  40miles;
  mcast-repeat       3;
  data-retries       3;
  fragment-threshold 0;
  remote-age-time    600;
  endpoint-age-time  300;
```





```

allow-retransmit      true;
arp-cache             false;
adr-mode              none;
adr-threshold         -70;
encryption-protocol   2.0;
}

```

## Security configuration

The default security mode, as shown above, is none. The configuration options are the same as an NX915 module operating in remote mode.

## Other configuration

The advanced configuration on an NX915 module operating as a Store-and-Forward device, shares the same configuration as a Remote. The NIC and Gateway Identifier are for use in manually configuring link paths a station will use in the network. The default value of 0 for the identifiers configured the NIC module to automatically obtain a path in the network. Manually setting the NIC ID to a specific value, allows you to configure Remotes to use that value as their Gateway ID. Doing so will cause the Remote to only synchronize with this Store-and-Forward device to gain network access.

## Monitoring

Ensure the CLI is in operational mode.

## Access Point Mode

The following shows status with two remotes connected.

```

> show interfaces-state interface NxRadio nx-status | tab
nx-status init-status complete
nx-status current-device-mode access-point
nx-status current-modem 500kbps
nx-status alarms ""
nx-status serial-number 2652308
nx-status firmware-revision 0.6.0
nx-status hardware-id 14
nx-status hardware-revision 3
nx-status temperature 46
nx-status mac-stats tx-success 5903
nx-status mac-stats tx-fail 1
nx-status mac-stats tx-queue-full 0
nx-status mac-stats tx-no-sync 0
nx-status mac-stats tx-no-assoc 0
nx-status mac-stats tx-error 0
nx-status mac-stats tx-retry 1253
nx-status mac-stats rx-success 6940
nx-status mac-stats sync-check-error 0
nx-status mac-stats sync-change 0

```

ADDRESS	IP ADDRESS	TIME TO LIVE	LINK STATUS	NIC ID	AVG RSSI	AVG LQI	TX PACKETS	TX BYTES	RX PACKETS	RX BYTES	TX ERROR	RX ERROR	TX DROP	RX DROP
00:06:3d:07:3e:3a	10.15.65.184	179	associated	1	-70	7	13	780	435	22933	0	0	0	0
00:06:3d:07:67:f9	10.15.65.182	179	associated	2	-69	9	1597	285716	2431	2444359	0	0	0	0



CHANNEL	FREQUENCY	AVG RSSI	AVG LQI
0	902.700000	-66	8
3	903.622500	-66	9
6	904.545000	-66	8
9	905.467500	-67	8
12	906.390000	-67	8
15	907.312500	-68	7
18	908.235000	-69	9
21	909.157500	-69	8
24	910.080000	-70	8
27	911.002500	-70	8
30	911.925000	-70	8
33	912.847500	-70	8
36	913.770000	-70	9
39	914.692500	-70	7
42	915.615000	-69	9
45	916.537500	-69	8
48	917.460000	-69	8
51	918.382500	-68	8
54	919.305000	-68	8
57	920.227500	-68	10
60	921.150000	-69	7
63	922.072500	-69	8
66	922.995000	-70	9
69	923.917500	-71	10
72	924.840000	-72	8
75	925.762500	-72	7
78	926.685000	-73	7

## Remote and Store-and-Forward Mode

The following shows status when connected to a configured Access Point.

```
> show interfaces-state interface NxRadio nx-status
nx-status link-status associated
nx-status init-status complete
nx-status current-device-mode remote
nx-status current-modem 500kbps
nx-status alarms ""
nx-status serial-number 2501772
nx-status firmware-revision 0.6.0
nx-status hardware-id 13
nx-status hardware-revision 3
nx-status temperature 49
nx-status ap-info ap-address 00:06:3d:09:06:01
nx-status ap-info ip-address 10.15.65.146
nx-status ap-info connected-time 0
nx-status ap-info avg-rssi -70
nx-status ap-info avg-lqi 7
nx-status mac-stats tx-success 19083
nx-status mac-stats tx-fail 0
```



nx-status mac-stats tx-queue-full 0  
nx-status mac-stats tx-no-sync 1  
nx-status mac-stats tx-no-assoc 0  
nx-status mac-stats tx-error 0  
nx-status mac-stats tx-retry 4330  
nx-status mac-stats rx-success 419096  
nx-status mac-stats sync-check-error 5  
nx-status mac-stats sync-change 21

CHANNEL	FREQUENCY	AVG RSSI	AVG LQI
0	902.700000	-68	7
3	903.622500	-69	6
6	904.545000	-69	6
9	905.467500	-69	6
12	906.390000	-70	6
15	907.312500	-70	7
18	908.235000	-71	5
21	909.157500	-71	5
24	910.080000	-72	6
27	911.002500	-72	6
30	911.925000	-71	5
33	912.847500	-71	6
36	913.770000	-71	7
39	914.692500	-71	6
42	915.615000	-71	6
45	916.537500	-70	7
48	917.460000	-70	7
51	918.382500	-70	6
54	919.305000	-69	7
57	920.227500	-68	12
60	921.150000	-70	7
63	922.072500	-70	7
66	922.995000	-70	7
69	923.917500	-72	7
72	924.840000	-72	7
75	925.762500	-72	6
78	926.685000	-72	7



### 3.5.5 Licensed Narrowband (LN)

#### Understanding

Licensed Narrowband Modules are available in various global frequencies.

The term “LN” is used to denote *all* licenced narrowband modules within the Orbit family. Specific identification, such as “LN400,” is used when necessary to reference band-specific hardware.

The LN NIC modules are reliable point-to-multipoint, wireless data transmission products. An LN NIC can operate as an Access Point or Remote.

Licensed Narrowband modules provide robust long-distance communication in channel bandwidth sizes of 6.25KHz, 12.5KHz, and 25KHz. Depending on bandwidth, raw data rates range from 20kbps to 120kbps. The radio is suitable to interface both Ethernet and Serial controllers such as PLCs, RTUs and SCADA systems while offering greater throughput than traditional FSK solutions. The module utilizes QAM modulation, a highly efficient PA, and a direct conversion receiver to provide dependable wireless communications. An advanced Media Access Control provides advanced interference avoidance, error detection, retransmission, auto repeat, and guaranteed collision free data. 10-Watts of peak power and dynamic FEC extend coverage to up to 50 miles.

The specifications for the LN400 NIC module:

- Frequency Range(s): 406-470 MHz, 330-406 MHz
- FCC Part 90 (private land mobile radio services)
- FCC ID: E5MDS-LN400
- ICID: 101D-LN400

The specifications for the LN900 NIC module:

- Frequency Range: 896-960 MHz
- FCC Part 90 (private land mobile radio services) & Part 101
- FCC ID: E5MDS-LN900
- ICID: 101D-LN900

The general specifications for all LN NIC modules are:

- Power Output: 20 dBm to 40 dBm peak power in 1.0 dBm steps (DEFAULT = 40 dBm)
- Output Impedance: 50 Ohms
- Antenna Connector: TNC female
- Modulation Type: QPSK, 16QAM, 64QAM
- FEC: Convolutional and Reed Solomon
- Data Rates: 20kbps - 120kbps



Multiple modulation rate / bandwidth combinations are provided; as seen in Table 3-15.

**Table 3-15. Modulation and Bandwidth for LN radios**

RF Channel Bandwidth	Modem Symbol rate	QPSK (x2) OTA rate	16QAM (x4) OTA rate	64QAM (x6) OTA rate
6.25 KHz	4800 sps	9600 bps	19200 bps	28800 bps
12.5 KHz	9600 sps	19200 bps	38400 bps	57600 bps
12.5 KHz	10000 sps	20000 bps	40000 bps	60000 bps
25.0KHz	16000 sps	32000 bps	64000 bps	96000 bps
25.0KHz	20000 sps	40000 bps	80000 bps	120000 bps

---

**NOTE** The only required steps for basic configuration are: Program transmit and receive frequencies per user licensing; program a network name in all units; establish one unit as the AP

---

Minimal configuration is necessary but several advanced tuning facilities are provided.

By default the radio ships from the factory with a 12.5KHz bandwidth and 10k-symbol/sec data rate. Modem operation is configured for Adaptive Modulation with FEC enabled. Transmit and Receive frequencies are unprogrammed and left to field installation personnel to prevent inadvertant operation on the wrong channel.

For the advanced user, the module supports configuring more items including:

- **Data Retries** - Number of times to retry unicast data before declaring NACK.
- **Power** – RF output power control.
- **ARP Cache** – Feature that limits over-the-air ARP traffic
- **Data and Header Compression** – facilities to use LZ0 data compression for payload and robust header compression to reduce packet overhead
- **FEC** – facility to selectively enable Forward Error Correction trading off speed and robustness
- **Allow Retransmit** – facility to enable peer-to-peer traffic

In general, it is recommended that users start with the simplest configuration and then make parameter changes as necessary to meet specific needs.

---

**NOTE** To meet country specific regulatory requirements, parameter restrictions may be configured by the factory. These settings can NOT be changed or modified by the user. See the table above:

---

**Table 3-16. Country Limitations Example**

Country	Limitation
USA	Prohibit LN400 25KHz operation using 20ksps (Except at 450 MHz – 470 MHz)

**Table 3-17. LNxxx Interface LED Descriptions**



LED - NIC2	State	Description
LnRadio Interface	Off	Interface disabled
Access Point Mode	Blink Red	NIC Initialization
	Solid Red	No Remotes connected
	Solid Green	Linked with at least 1 Remote
Remote Mode	Blink Red	NIC Initialization / Not linked to an Access Point
	Solid Green	Linked with Access Point

## Important Notes and Information Regarding EVM

EVM (error vector magnitude) is dependent on the modulation format and should be used as a relative measurement of the link quality. A low EVM value indicates a better link quality than a high value. Algorithmically, using QAM modulation, the transceiver calculates the value by measuring the sample points of each "bit" and comparing it with the expected constellation based on the modem type.

- EVM is a metric of the quality of the received signal. It is a dynamic value that is computed only when data is received on the RF interface, and should be refreshed accordingly.
- Unlike RSSI which simply measures signal strength, EVM is a measurement of the "correctness" of this signal. (This means how easily the received signal can be correctly demodulated.)
- In general the lower the EVM the better the quality. A strong link will typically show an EVM below 5.

## Adaptive Modulation

The adaptive modulation mode (modulation automatic) allows directed traffic to adjust which modem is used on a per-transmission basis. Adaptive modulation works in both upstream and downstream mode. The mode selection varies between QPSK, 16QAM, and 64QAM. A signal metric score is used to decide which modem selection to use. The score is determined based on signal strength and packets received. Advanced configuration can be used to provide some control over the adaptive modulation thresholds.

The primary use case for this feature is if an AP has some remotes that are close to the AP and could support a higher data rate and some farther away (or obstructed) that can only support a lower data rate. This mode allows the close remotes to take advantage of the higher data rate for the directed messages, when otherwise the whole network would have had to be run at the lower data rate. Note that broadcast or multicast data must always be transmitted at the lowest rate.

We recommend keeping adaptive modulation set for most installations.

## Security

Setting the security mode to EAP or PSK will enable device authentication. When enabled, the remotes will authenticate with the AP (PSK) or a backend RADIUS server (EAP) before they are allowed to pass data on the network. The authentication protocol is compliant with IEEE 802.1X. If device authentication is enabled, over the air data encryption can also be enabled. This ensures all over the air traffic is protected. When encryption is enabled, the device must occasionally rotate the encryption keys. This rotation is logged in the event log with event type nx\_auth. These events can be suppressed in the event log configuration to prevent them from filling the event log. See section 3.6.2 for instruction on controlling the event log.



## Configuring

### Basic configuration with defaults

Navigate to: *Interfaces / LnRadio ---> Basic Config / LN Radio*

### LnRadio Interface

Status Basic Config Advanced Config Actions

General  
LN Radio

#### Ln Config

Radio Mode	<input type="text" value="standard"/>	
Device Mode	<input type="text" value="access-point"/>	
Network Name	<input type="text" value="mds_ln"/>	
Data Compression	<input type="text" value="lzo"/>	
Header Compression	<input checked="" type="checkbox"/>	
Power	<input type="text" value="20"/>	dBm
Tx Frequency	<input type="text" value="430"/>	MHz
Rx Frequency	<input type="text" value="410"/>	MHz
Channel	<input type="text" value="12.5KHz-9.6ksps"/>	
Modulation	<input type="text" value="automatic"/>	
Fec	<input type="text" value="adaptive-gain"/>	

**Figure 3-61. Licensed Narrowband (LN) Configuration Settings**

- **Device Mode** - Sets the role the radio will assume in the network.
  - Remote (DEFAULT)
  - AP
- **Network Name** - The name of the network. Used to control what networks the radio connects to. Valid values: 1 to 31 letters (DEFAULT is *mds\_ln*). The network name string is used to identify the logical network that the device should join. If the network name does not match, the device will log an event to identify network name collisions.
- **Data Compression** – Over the air compression
  - **lzo** - Compresses the over the air traffic with the LZO algorithm (DEFAULT)
  - **none** - No data compression
- **Header Compression** – Enabled by DEFAULT. Enable/disable over the air robust header compression. This feature compresses IP headers to improve system performance, and is most useful in applications that rely on IP packets with small payloads, such as terminal server operations or MODBUS polling. This setting must match on each radio (Remote and AP).
- **Power** - The transmit power of the radio: Valid values: 20 - 40 dBm – DEFAULT is 40dBm



- **TX Frequency** – The frequency at which the radio transmits. Valid values: none, 407-470 MHz. DEFAULT is none.
- **RX Frequency** – The frequency at which the radio receives. Valid values: none, 407-470 MHz. DEFAULT is none.

---

**NOTE** LN radios are shipped from the factory without set frequencies. The LN radio module will not power on until you enter specify a valid TX and RX frequency.

---

- **Channel** - Controls the channel bandwidth and symbol rate of the radio.
  - **6.25 kHz-4.8 ksps** - Channel width 6.25 kHz, symbol rate of 4.8 ksps
  - **12.5 kHz-9.6 ksps** - Channel width 12.5 kHz, symbol rate of 9.6 kbps (DEFAULT)
  - **12.5 kHz-10 ksps** - Channel width 12.5 kHz, symbol rate of 10 kbps
  - **25 kHz-16 ksps** - Channel width 25 kHz, symbol rate of 16 kbps
  - **25 kHz-20 ksps** - Channel width 25 kHz, symbol rate of 20 kbps

---

**NOTE** Some channel configurations may not be available for use because of country restrictions. See Table 3-16 for details.

---

- **Modulation** – Sets the radio’s modulation. You may select automatic (adaptive modulation), or choose from three fixed modulations.
  - **Adaptive** modulation (DEFAULT)
  - **QPSK**
  - **16QAM**
  - **64QAM**

Automatic modulation adaptively selects which which modem (QPSK, 16QAM, or 64QAM) is used on a per-transmission basis. This is useful in networks with some remotes close to the Access Point, and others farther away or obstructed. This mode allows the close remotes to take advantage of the higher data rate for the directed messages, while the remotes use a more conservative modulation.

Radios with fixed modulation settings will operate only at the modulation that you specify. If the specified modulation is higher than the connection can support, no traffic will flow. If the connection can support a higher modulation than the selected modulation, the radio will not take advantage of this and will continue to use the fixed modulation. **We recommend that Adaptive Modulation be used in all cases other than bench tests.**

Theoretical throughput is based on modulation and channel settings. Please refer to Table 3-15 above.

- **FEC** -- Forward Error Correction is useful in controlling errors in weak connections. FEC encodes data in a redundant fashion to allow data correction in a noisy or weak connection without the additional overhead of retransmission.
  - **Disabled** (DEFAULT). No Forward Error Correction will be used. This option provides the highest throughput and standard sensitivity, and is suitable for strong connections.
  - **Low Gain** – Provides better sensitivity, while still offering good throughput.
  - **Adaptive** – Provides the best sensitivity and standard throughput. Adaptive on a per-packet basis.

---

**NOTE** It is critical to have FEC set identically on the AP and all Remotes.

---





### Security

**i** Security Mode

**i** Encryption

**i** Passphrase

**i** Rekey Interval  minutes

Figure 3-62. Licensed Narrowband (LN) PSK Security Settings

### Security

**i** Security Mode

**i** Encryption

**i** EAP Mode

### PKI

**i** Certificate ID

**i** Key ID

**i** CA Certificate ID

Figure 3-63. Licensed Narrowband (LN) EAP on remote Security Settings

### Security

**i** Security Mode

**i** Encryption

**i** Radius Server

**i** Rekey Interval  minutes

Figure 3-64. Licensed Narrowband (LN) EAP on an access point Security Settings

- **Security Mode** - The type of over the air authentication to perform
  - **none** - Provide no device authentication or data privacy (DEFAULT)
  - **psk** - Use pre-shared key authentication protocol
  - **eap** - Use Encapsulated Authentication Protocol - will change the fields displayed and give the user the ability to enter radius info on the AP and certificate info on the remote.



- **Encryption** - The type of over the air encryption to perform
  - **none** - No data privacy (DEFAULT)
  - **aes128-ccm** - Protect data with 128-bit AES encryption using CCM mode
  - **aes256-ccm** - Protect data with 256-bit AES encryption using CCM mode
- **Passphrase** - The passphrase used in PSK mode, 8 to 64 letters. (DEFAULT=blank)
- **Certificate ID, Key ID, CA Certificate ID (*Remote EAP mode only*)** – Reference to the remotes certificate material loaded through the Certificate Management side menu (section 3.9).
- **Radius Server (*AP EAP mode only*)** – A reference to the RADIUS server configuration configured through the System – RADIUS side menu item (section 3.7.4).
- **Rekey Interval (*AP only*)** – The session key for an active secure link changes at a regular basis. You may increase the length of the rekey interval in order to reduce overhead caused by the rekeying communications between radios on a narrowband channel. Valid values:
  - 0 – Rekeying will not be time-based, but will instead occur every one million packets.
  - 30-525600 minutes, DEFAULT 180.

---

**NOTE** Remember to click on the **Save** button when finished.

---

## Advanced Configuration

### LnRadio Interface
















Status	Basic Config	Advanced Config	Actions
▼ Advanced Config			
	Data Retries	<input type="text" value="3"/>	
	Packet Ttl	<input type="text" value="2000"/>	milliseconds
	Remote Age Time	<input type="text" value="900"/>	seconds
	Endpoint Age Time	<input type="text" value="300"/>	seconds
	Allow Retransmit	<input checked="" type="checkbox"/>	
	Arp Cache	<input type="checkbox"/>	
	Qam 16 Threshold	<input type="text" value="-85"/>	dBm
	Qam 64 Threshold	<input type="text" value="-70"/>	dBm

Figure 3-65. Licensed Narrowband AP Advanced Settings



## LnRadio Interface

Status	Basic Config	Advanced Config	Actions
▼ Advanced Config			
 Data Retries	<input type="text" value="3"/>		
 Nic ID	<input type="text" value="0"/>		
 Packet Ttl	<input type="text" value="2000"/>	milliseconds	
 Remote Age Time	<input type="text" value="900"/>	seconds	
 Arp Cache	<input type="checkbox"/>		
 Qam 16 Threshold	<input type="text" value="-85"/>	dBm	
 Qam 64 Threshold	<input type="text" value="-70"/>	dBm	

**Figure 3-66 Licensed Narrowband (LN) Remote Advanced Settings**

The Advanced Setting menu appears slightly different on APs than on Remotes.

- **Data Retries** - Number of times to retry unicast data before declaring failure. Valid values: 0—15, DEFAULT = 3.
- **Packet TTL (Time-to-Live)** – Length of time, in milliseconds, of inactivity of all over-the-air traffic before registering a disconnection. The radio will then attempt to reconnect to the network. Valid values: 100 to 65535 ms, DEFAULT = 2000 (2 seconds).
- **Remote Age Time** – Length of time, in seconds, of inactivity of a remote before it is disconnected. Valid values: 180-4294967295 seconds, DEFAULT = 600 (10 minutes).
- **Endpoint Age Time (AP only)** - Length of time in seconds of inactivity on an endpoint before it is removed from the endpoint database. Range of 0 to 4294967295 seconds. DEFAULT = 300 (5 minutes).
- **Allow Retransmit (AP only)** – All traffic from the remotes is sent to the AP. When enabled the AP will retransmit traffic from one remote to another based on the MAC address. It will also resend any remotes broadcast traffic to all other remotes. Disabled by DEFAULT.
- **NIC ID (Remote only)** – **ADVANCED SETTING - DO NOT CHANGE** - Manually overrides the NIC identifier.
- **ARP Cache** – Enabled by DEFAULT. When enabled, the radio will respond to ARP requests intended for other network devices with known addresses. It will not forward the ARP to the intended device. This is similar to ARP proxy.
- **QAM 16 Threshold** – When the radio is using automatic modulation, it will automatically switch to QAM 16 modulation when the averaged calculated RSSI value drops below this value. Valid values: -100 to 0 dBm, DEFAULT = -85 dBm. If you set the value to 0, this modulation is disabled.
- **QAM 64 Threshold** – When the radio is using automatic modulation, it will automatically switch to QAM 64 modulation when the averaged calculated RSSI value drops below this



value. Valid values: -90 to 0 dBm, DEFAULT = -70 dBm. If you set the value to 0, this modulation is disabled.

## Monitoring

General Interface information: *Interfaces / LnRadio ---> Status / General*

### LnRadio Interface

Type*	In
Admin Status*	up
Oper Status*	up
If Index*	4
Phys Address	00:06:3d:07:67:f9

**Figure 3-67. Licensed Narrowband (LN) AP Status**

- **Type** - The type of the interface. Licensed Narrowband radios appear as “In.”
- **Admin Status** - The desired state of the interface.
- **Oper Status** - The current operational state of the interface.
- **If Index** - The index value for this interface in the Orbit’s interface table. Valid values are: 1-2147483647
- **Phys Address**- The interface’s address at its protocol sub-layer. For a LN module, this object normally contains a MAC address.

## Statistics - A collection of interface-related statistics objects.

### LnRadio Interface

Discontinuity Time*	Wed, 02 Jan 2013 10:10:26 GMT
In Octets	204390
In Unicast Pkts	1066
In Multicast Pkts	0
In Discards	0
In Errors	0
Out Octets	619490
Out Unicast Pkts	6189
Out Discards	0
Out Errors	4

**Figure 3-68. Licensed Narrowband (LN) Statistics**



- **Discontinuity Time** - The time on the most recent occasion at which one or more of this interface's counters suffered a discontinuity.
- **In Octets** - The total number of octets received on the interface, including framing characters.
- **In Unicast Pkts** - The number of packets, delivered by this sub-layer to a higher (sub-)layer, which were not addressed to a multicast or broadcast address at this sub-layer.
- **In Multicast Pkts** - The number of packets, delivered by this sub-layer to a higher (sub-)layer, which were addressed to a multicast address at this sub-layer.
- **In Discards** - The number of inbound packets which were chosen to be discarded even though no errors had been detected to prevent their being deliverable to a higher-layer protocol. One possible reason for discarding such a packet could be to free up buffer space.
- **In Errors** - For packet-oriented interfaces, the number of inbound packets that contained errors preventing them from being deliverable to a higher-layer protocol.
- **Out Octets** - The total number of octets transmitted out of the interface, including framing characters.
- **Out Unicast Pkts** - The total number of packets that higher-level protocols requested be transmitted, and which were not addressed to a multicast or broadcast address at this sub-layer, including those that were discarded or not sent.
- **Out Discards** - The number of outbound packets which were chosen to be discarded even though no errors had been detected to prevent their being transmitted.
- **Out Errors** - For packet-oriented interfaces, the number of outbound packets that could not be transmitted because of errors.

## Ln Radio Status Monitoring:

*Interfaces / LnRadio ---> Status / Ln Radio*

**LnRadio Interface**

Status Basic Config Advanced Config Actions

▶ General  
 ▶ Statistics  
 ▼ LN Radio

Init Status	complete	Refresh every <input type="text"/> seconds
Current Device Mode	access-point	
Alarms		
Rate		
Firmware Revision	0.2.4	
Temperature	45	

**Figure 3-69. Licensed Narrowband (LN) Status**

The following status items appear on both APs and Remotes (unless stated otherwise)

*General*

- **Init Status** - State of the NIC Initialization
  - **Off** - Not operating
  - **Initializing** - Powering on the NIC
  - **Discovering** - Determining the NIC address
  - **Reprogramming** - Programming the NIC firmware



- **Configuring** - Configuring the NIC
- **Complete** - Initialization complete
- **Current Device Mode** – Read-only display of the active mode the LnRadio is operating.
- **Alarms** - The current NIC alarms:
  - synthesizer-out-of-lock: Synthesizer is out of lock. Call GE MDS tech support for assistance.
  - radio-not-calibrated: Radio was not calibrated. Call GE MDS tech support for assistance.
  - internal-temp: The radio’s internal temperature exceeds the operating threshold.
- **Firmware Revision** - NIC Firmware Revision.
- **Temperature** - The transceiver temperature in degrees C.

*Modem Stats*

<b>Modem Stats</b>	
Modem Tx Success	2649
Modem Tx Error	0
Modem Rx Success	3840944
Modem Rx Error	1

- **Modem Tx Success** – Number of packets successfully transmitted by the modem.
- **Modem Tx Error** – Number of transmit errors reported by the modem.
- **Modem Rx Success** – Number of packets successfully received by the modem.
- **Modem Rx Error** – Number of receive errors reported by the modem.

*MAC Stats*

<b>MAC Stats</b>	
MAC Tx Success	806
MAC Tx Queue Full	0
MAC Tx Error	0
MAC Tx Retry	156
MAC Rx Success	51378
MAC Rx Error	1

- **MAC Tx Success** - Successful transmissions.
- **MAC Tx Queue Full** - Failed transmissions, MAC queue full.
- **MAC Tx Error** - Packets dropped for other reasons.
- **MAC Tx Retry** - Re-transmission count due to previously unsuccessful transmission.
- **MAC Rx Success** - Valid packet received.
- **MAC Rx Error** – Received packets dropped due to error.



Last Rx Packet	
Last RSSI	-70 dBm
Last Evm	1
Last Modulation	qam64
Rate	96 kbps

- **Last RSSI** – The RSSI measured at the time of the last received packet.

**Last Error Vector Magnitude** – The EVM measured at the time of the last received packet. For more information, refer to *Important Notes and Information Regarding EVM*

- **Last Modulation** – The modulation measured at the time of the last received packet.
- **Rate** – The calculated over the air rate from Table 3-15.

Hardware Info	
Serial Number	2661839
Hardware ID	0
Hardware Revision	0

Figure 3-70 Licensed Narrowband (LN) Hardware Info

Information about the Licensed Narrowband NIC’s hardware is also displayed on the LN Radio’s Statistics menu. This information may be helpful when calling technical support.

### Connections Status (AP Only)

In AP mode the “Connected Remotes” and “Endpoints” information will be displayed in addition to the Active Channel.

**NOTE** Clicking on the MAC address in either Connected Remotes or Endpoints will bring up more stats.

**NOTE** Highlighting a MAC address of a Connected Remote and clicking Remote Web Connect will open a remote web UI session to the selected remote. See Section 3.8.16, Remote Management Service, for more information.

Connected Remotes						
Search <input type="text"/>		Remote Web Connect		<span>📶</span> <span>🔄</span> <span>👁</span> <span>🔍</span> <span>🔧</span>		
Address	IP Address	Time to Live	Link Status	RSSI	Evm	Rx Modulation
00:06:3d:09:14:7d	10.15.65.145	740	associated	-70	0	qam64
Showing 1 to 1 of 1						
Endpoints						
Search <input type="text"/>		<span>📶</span> <span>🔄</span> <span>👁</span> <span>🔍</span> <span>🔧</span>				
Address	IP Address	Time to Live	Remote Address	Device Stats - Tx Packets	Device Stats - Tx Bytes	Device Stats - Rx Packets
Table is empty						

Figure 3-71. Licensed Narrowband (LN) AP Connection Status



## Remote's AP Info (Remote Only):

AP Info	
AP Address	00:06:3d:09:0d:d8
IP Address	192.168.1.51
Connected Time	3 seconds
RSSI	-68 dBm
Evm	0
Rx Modulation	qam64

**Figure 3-72. Licensed Narrowband (LN) Remote's AP Information**

- **AP Address** - MAC address of access point this device is linked to.
- **IP Address** - IP address of access point this device is linked to.
- **Connected Time** - Time elapsed in seconds since link established. After 4294967295 seconds, the value displayed rolls over to 0.
- **RSSI** - The RSSI measured at the time of the last received packet. If using this reading to align an antenna or gather link status information, we recommend setting the page refresh to 3 seconds.
- **EVM** - The Error Vector Magnitude measured at the time of the last received packet. For more information, refer to refer to *Important Notes and Information Regarding EVM*
- **Rx Modulation** - The modulation measured at the time of the last received packet.





## Test Mode

*Interfaces / LnRadio ---> Actions*

### LnRadio Interface

Status	Basic Config	Advanced Config	Actions
<b>Test Mode</b>			
Time	<input type="text" value="5"/>	minutes	
State	<input type="text" value="receive"/>		
<input type="button" value="Perform action"/>			
<b>Test Values</b>			
Test Mode Time	4 minutes	<input type="button" value="Refresh"/>	every <input type="text"/> seconds
Test State	receive		
Test RSSI	-128 dBm		

Test Mode provides a way to place the transmitter on the air to check the measured RF power output, measure reflected power from an antenna system, or to provide a signal at a receiving station so that RSSI can be checked. While in Test Mode, a radio will not operate normally and does not communicate with the narrowband network.

To enter or exit Test Mode, select the desired test state from the **State** drop-down box and click **Perform Action**.

- **Time** – The time, in minutes, to remain in test mode before automatically resuming normal operation. We recommend that you remain in test mode 10 minutes or less.
- **State** -
  - **Receive** – Enter Receive mode to check the RSSI of a received signal.
  - **Keyed** – Key the transmitter. To prevent damage to the radio, the unit will stop keying after one minute and automatically transition to the Receive state.
  - **Stop** – Stop all test operations and exit test mode.

### Test Values

- **Test Mode Time** – The length of time test mode has been running.
- **Test State** – *Receive, Keyed, Stop*. The current test state.
- **Test RSSI** (Receive Mode only) – The current signal RSSI.

## CLI Configuration Examples

### AP Mode

On the next page, the example will display how to configure the LN module as an access point with the network name of 'MyNetwork' and default settings. For this example we assume a transmit frequency of



451.4 MHz and a receive frequency of 456.4 MHz. Your own LN frequencies must be set according to your user license.

```
% set interfaces interface LnRadio In-config device-mode access-point network-name MyNetwork
tx-frequency 451.4 rx-frequency 456.4
% show interfaces interface LnRadio In-config | details
radio-mode          standard;
device-mode         access-point;
network-name        MyNetwork;
data-compression    lzo;
header-compression  true;
power               40;
tx-frequency        451.4;
rx-frequency        456.4;
channel             12.5KHz-9.6ksps;
modulation          automatic;
fec                 false;
security {
  security-mode     none;
  encryption        none;
}
advanced-config {
  data-retries      3;
  packet-ttl        600;
  remote-age-time   600;
  endpoint-age-time 300;
  allow-retransmit  true;
  arp-cache         false;
  qam16-threshold   -85;
  qam64-threshold   -70;
}
}
```

## Security configuration

The default security mode, as shown above, is none.

The following configures the LN module to use pre-shared key authentication with the passphrase 'mypassphrase' and aes256-ccm encryption.

---

**NOTE** When viewing the configuration, the passphrase that you entered is not displayed in plaintext. This is a security measure.

---

```
% set interfaces interface LnRadio In-config security encryption aes256-ccm security-mode
psk passphrase mypassphrase
% show interfaces interface LnRadio In-config | details
radio-mode          standard;
device-mode         access-point;
network-name        MyNetwork;
data-compression    lzo;
header-compression  true;
power               40;
tx-frequency        451.4;
rx-frequency        456.4;
channel             12.5KHz-9.6ksps;
```



```
modulation      automatic;
fec             false;
security {
  security-mode  psk;
  encryption     aes256-ccm;
  passphrase     $4$BfPtSIDWFNhtqe4ZcJTWQQ==;
}
advanced-config {
  data-retries   3;
  packet-ttl     600;
  remote-age-time 600;
  endpoint-age-time 300;
  allow-retransmit true;
  arp-cache      false;
  qam16-threshold -85;
  qam64-threshold -70;
}
}
```

The following configures the LN module to use data compression, EAP authentication and aes256-ccm encryption. The radius server used by the EAP authentication is selected from a list of configured Radius servers.

```
% set interfaces interface LnRadio In-config security encryption aes256-ccm security-mode
  eap radius-server RADIUS_SERVER
% show interfaces interface LnRadio In-config | details
radio-mode      standard;
device-mode     access-point;
network-name    MyNetwork;
data-compression lzo;
header-compression true;
power           40;
tx-frequency    451.4;
rx-frequency    456.4;
channel         12.5KHz-9.6ksps;
modulation      automatic;
fec             false;
  security {
    security-mode  eap;
    encryption     aes256-ccm;
    radius-server  RADIUS_SERVER;
  }
advanced-config {
  data-retries   3;
  packet-ttl     600;
  remote-age-time 600;
  endpoint-age-time 300;
  allow-retransmit true;
  arp-cache      false;
  qam16-threshold -85;
  qam64-threshold -70;
}
}
```



## Remote Mode

The following will configure the LN module as a Remote with the network name of 'MyNetwork' and default settings. For this example we assume the inverse of the AP frequency plan – a transmit frequency of 456.4 MHz and a receive frequency of 451.4 MHz. Your own LN frequencies must be set according to your user license.

```
% set interfaces interface LnRadio In-config device-mode remote network-name MyNetwork tx-
frequency 456.4 rx-frequency 451.4
% show interfaces interface LnRadio In-config | details
radio-mode          standard;
device-mode         remote;
network-name       MyNetwork;
data-compression   lzo;
header-compression true;
power              40;
tx-frequency       456.4;
rx-frequency       451.4;
channel            12.5KHz-9.6ksps;
modulation         automatic;
fec                false;
security {
  security-mode    none;
  encryption       none;
}
advanced-config {
  data-retries     3;
  nic-id           0;
  inactivity-timeout 600;
  remote-age-time  600;
  arp-cache        false;
  qam16-threshold  -85;
  qam64-threshold  -70;
}
```

## Security Configuration

The default security mode, as shown above, is none. The following configures the LN module to use pre-shared key authentication with the passphrase “mypassphrase” and aes256-ccm encryption.

---

**NOTE** When viewing the configuration, the passphrase that you entered is not displayed in plaintext. This is a security measure.

---

```
% set interfaces interface LnRadio In-config security encryption aes256-ccm security-mode
psk passphrase mypassphrase
% show interfaces interface LnRadio In-config | details
radio-mode          standard;
device-mode         remote;
network-name       MyNetwork;
data-compression   lzo;
header-compression true;
power              40;
tx-frequency       456.4;
rx-frequency       451.4;
;
```



```
channel          12.5KHz-9.6ksps;
modulation       automatic;
fec              false;
security {
  security-mode  psk;
  encryption     aes256-ccm;
  passphrase     $4$BfPtSIDWFNhtqe4ZcJTWQQ==;
}
advanced-config {
  data-retries   3;
  nic-id         0;
  inactivity-timeout 600;
  remote-age-time 600;
  arp-cache     false;
  qam16-threshold -85;
  qam64-threshold -70;
}
```

The following configures the LN module to use data compression, EAP authentication and aes128-ccm encryption. The EAP mode currently supports only EAP-TLS. This requires configuring the appropriate PKI Certificates and Keys to use in the TLS authentication. This information is selected from the PKI configuration.

```
% set interfaces interface LnRadio In-config security encryption aes128-ccm security-mode
eap eap-mode eap-tls pki ca-cert-id CACert key-id DevicePrivKey cert-id DevicePubCert
% show interfaces interface LnRadio In-config | details
radio-mode          standard;
device-mode         remote;
network-name        MyNetwork;
data-compression    lzo;
header-compression  true;
power               40;
tx-frequency        456.4;
rx-frequency        451.4;
channel             12.5KHz-9.6ksps;
modulation          automatic;
fec                 false;
security {
  security-mode     eap;
  encryption        aes128-ccm;
  eap-mode          eap-tls;
  pki {
    cert-id         DevicePubCert;
    key-id          DevicePrivKey;
    ca-cert-id      CACert;
  }
}
advanced-config {
  data-retries      3;
  nic-id            0;
  inactivity-timeout 600;
  remote-age-time   600;
}
```



```
arp-cache          false;
qam16-threshold    -85;
qam64-threshold    -70;
}
```

## Monitoring

Ensure the CLI is in operational mode.

## Access Point Mode

The following shows status with two stations connected.

```
> show interfaces-state interface LnRadio In-status
In-status init-status complete
In-status current-device-mode access-point
In-status alarms ""
In-status firmware-revision 0.2.4
In-status temperature 45
In-status modem-stats modem-tx-success 5401378
In-status modem-stats modem-tx-error 0
In-status modem-stats modem-rx-success 37645
In-status modem-stats modem-rx-error 11
In-status mac-stats mac-tx-success 72699
In-status mac-stats mac-tx-queue-full 0
In-status mac-stats mac-tx-error 0
In-status mac-stats mac-tx-retry 132
In-status mac-stats mac-rx-success 17952
In-status mac-stats mac-rx-error 498
In-status last-rx-packet last-rssi -128
In-status last-rx-packet last-evm 255
In-status last-rx-packet last-modulation qam64
In-status last-rx-packet rate 96
In-status hardware-info serial-number 2673840
In-status hardware-info hardware-id 0
In-status hardware-info hardware-revision 0
In-status test test-mode-time 0
In-status test test-state stop
In-status connected-remotes 00:06:3d:09:14:7d
ip-address 10.15.65.145
time-to-live 767
link-status associated
rssi -67
evm 0
rx-modulation qam64
device-stats tx-packets 730
device-stats tx-bytes 108661
device-stats rx-packets 721
device-stats rx-bytes 215575
device-stats tx-error 10
device-stats rx-error 0
device-stats tx-drop 0
device-stats rx-drop 0
nic-id 1
```



## Remote Mode

The following shows status when connected to a configured Access Point.

```
> show interfaces-state interface LnRadio In-status
In-status link-status associated
In-status init-status complete
In-status current-device-mode remote
In-status alarms ""
In-status firmware-revision 0.2.4
In-status temperature 43
In-status modem-stats modem-tx-success 33116
In-status modem-stats modem-tx-error 0
In-status modem-stats modem-rx-success 197463
In-status modem-stats modem-rx-error 55283
In-status mac-stats mac-tx-success 11424
In-status mac-stats mac-tx-queue-full 0
In-status mac-stats mac-tx-error 0
In-status mac-stats mac-tx-retry 0
In-status mac-stats mac-rx-success 13390
In-status mac-stats mac-rx-error 1
In-status ap-info ap-address 00:06:3d:09:0d:d8
In-status ap-info ip-address 192.168.1.51
In-status ap-info connected-time 174
In-status ap-info rssi -68
In-status ap-info evm 0
In-status ap-info rx-modulation qpsk
In-status last-rx-packet last-rssi -68
In-status modem-stats modem-tx-success 33116
In-status modem-stats modem-tx-error 0
In-status modem-stats modem-rx-success 198622
In-status modem-stats modem-rx-error 55283
In-status mac-stats mac-tx-success 11424
In-status mac-stats mac-tx-queue-full 0
In-status mac-stats mac-tx-error 0
In-status mac-stats mac-tx-retry 0
In-status mac-stats mac-rx-success 13390
In-status mac-stats mac-rx-error 1
In-status ap-info ap-address 00:06:3d:09:0d:d8
In-status ap-info ip-address 192.168.1.51
In-status ap-info connected-time 226
In-status ap-info rssi -68
In-status ap-info evm 0
In-status ap-info rx-modulation qpsk
In-status last-rx-packet last-rssi -68
In-status last-rx-packet last-evm 0
In-status hardware-info serial-number 2661832
In-status hardware-info hardware-id 0
In-status hardware-info hardware-revision 0
In-status test test-mode-time 0
In-status test test-state stop
```



## Test Mode

Ensure the CLI is in operational mode.

To enter Test Mode and key the transmitter for 5 minutes:

**> request interfaces-state interface *LnRadio* ln-status test-mode state keyed time 5**

To enter Test Mode's receive state for 5 minutes:

**> request interfaces-state interface *LnRadio* ln-status test-mode state receive time 5**

To exit Test Mode:

**> request interfaces-state interface *LnRadio* ln-status test-mode state stop**

To display the current test state:

**> show interfaces-state interface *LnRadio* ln-status test**







## 3.6 System Health and Status

### 3.6.1 Device Overview

#### Understanding

The *Device Overview* screen is displayed upon initial UI logon and provides a quick view of the device status including the product identification information, alarms and interface status.

#### Device Overview

##### Summary

- Name** Lynx
- Contact**
- Product Configuration** MXNTL4ENW51NNS1F5NUNE
- Platform Serial Number** 2674917
- Uptime** up 1 days, 02:46:41

##### Services

Name	Status
VPN	disabled
Serial	running
Firewall	running
DHCP Server	disabled
GPS Service	disabled

Showing 1 to 5

Previous   Next

##### Current Alarms

Name	Event ID	Type	Status	Message	Time Stamp	Clear
Table is empty						

##### Bridge

- Type\*** bridge
- Admin Status\*** up
- Oper Status\*** up
- Phys Address** 00:06:3d:09:12:1c
- In Octets** 4761994
- Out Octets** 5973084
- IP Address** 10.15.65.142

Interface	State
ETH1	forwarding
ETH2	disabled
LnRadio	forwarding
GEMDS_2674917	

Showing 1 to 4 of 4

##### Ln Radio

- Type\*** ln
- Admin Status\*** up
- Oper Status\*** up
- Phys Address** 00:06:3d:09:12:1c
- In Octets** 5016
- Out Octets** 5834476
- Current Device Mode** access-point
- Init Status** complete

##### Connected Remotes

Address	IP Address	RSSI
00:06:3d:09:14:7d	10.15.65.145	-82

Showing 1 to 1 of 1

##### Wi Fi

- Type\*** wifi
- Admin Status\*** down
- Oper Status\*** not-present
- Phys Address**
- In Octets** 0
- Out Octets** 0
- Mode** unknown
- Tx Power** 0
- Channel** 0
- Access Point**

### 3.6.2 Event Logging

#### Understanding

An event is a notification that something meaningful occurred on the unit. Events contain information about the occurrence that may be useful for administrators. The event can be stored locally and/or transported to a remote server by using the log export feature and then clearing the log.

#### Logging

Status
Basic Config
Actions

▼ Current Alarms

### Current Alarms

Name	Event ID	Type	Status	Message	Time Stamp	Clear
Table is empty						

▶ Event Log

Also the device supports external logging using SysLog or the Netconf - as described below. Administrators can override the default event handling of the unit.



The unit is designed to store up to 10100 events before rolling over losing event history. An alarm (**eventlog\_high\_water**) is generated when approaching the maximum event storage limit. Another alarm (**eventlog\_full**) is generated when the maximum value is reached. Each time the log reaches the maximum the value 100 oldest events will be deleted.

By default for security the logging is configured to be verbose and the log file may fill in a relatively short time for a very active system.

All events can be configured to be logged to any combination of the following locations based on the event type:

- **Local:** Store event in the local event log.
- **Netconf-notification:** generate a NETCONF notification
- **Syslog:** Forward events to a remote syslog server.

There are a number of default rules which can be modified to be active on the web UI. Refer to the **Default Event Rule** table located on the page *Logging---* **Basic Config**.

Each rule has the following setting types:

- **Name** - system recognized short name
- **Description** - Supplied descriptive text
- **Local** - If true, this event is stored in the local event log. True/False
- **Priority** - If logging to Syslog
  - alert - action must be taken immediately
  - crit - critical condition
  - debug - debug-level messages
  - emerg - system is unusable
  - err - error condition
  - info - informational set
  - notice - normal but significant condition
  - warning - warning condition
- **Syslog Facility** - If logging to SysLog selection of : auth, authpriv, cron, daemon, ftp, kern, lpr, mail, news, syslog, user, uucp, local0, local1, local2, local3, local4, local5, local6, local7
- **Syslog** - If true, forward events of this type to a syslog server.
- **SNMP Notification** - If true, generate an SNMP notification (trap or inform) for events of this type.
- **SNMP Notify Name** - Selection of a set of management targets which should receive notifications, as well as the type of notification (trap/inform). These should be sent to each selected management target. If the notify-name is not configured, the notification is sent to all configured targets
- **NETCONF Notification** - If true, generate a NETCONF notification for events of this type.
- **Alarm** - If true, generate an alarm output for events of this type.
- **Alarm Outputs** - Generate an alarm on all of these alarm outputs.

Logs are stored in the Event Log, which may be viewed on the Web UI by navigating to *Logging ---> Status* and scrolling down to **Event Log** section, as shown in the following example.



## Logging ↻

Status Basic Config Actions

Current Alarms

Event Log

### Event Log

Search

ID	Time Stamp	Priority	Event Type	Status	Message
45	2013-01-06T02:25:07.711612+00:00	notice	web_login	success	action login, service web, src_ipv4 192....
44	2013-01-06T02:23:56.200083+00:00	notice	cell_sim_change		action modify, service cell, msg old=unk...
43	2013-01-06T02:18:23.168895+00:00	notice	cell_sim_change		action modify, service cell, msg old=unk...
42	2013-01-06T02:13:14.241597+00:00	notice	web_logout		action logout, service web, src_ipv4 192...
41	2013-01-06T02:12:50.113674+00:00	notice	cell_sim_change		action modify, service cell, msg old=unk...
40	2013-01-06T02:07:16.931573+00:00	notice	cell_sim_change		action modify, service cell, msg old=unk...
39	2013-01-06T02:04:04.617005+00:00	info	host_copy_image	success	action copy, msg Successfully copied hos...
38	2013-01-06T02:01:43.742542+00:00	notice	cell_sim_change		action modify, service cell, msg old=unk...
37	2013-01-06T02:00:28.880253+00:00	info	host_verify_image	success	action read, msg Successfully verified h...
36	2013-01-06T01:57:44.672355+00:00	info	host_reprogram_image	success	action install, file_name mcr-bkrc-4_0_2...

Showing 1 to 10

Previous Next

From the CLI this can be viewed with the command:

**> show table logging event-log**

The default setting may be overridden by adding an event rule. For example the follow shows the cell connect/disconnect disabled for local logging - this would be useful in an environment where the cell modem reconnects many times as part of normal operations.

## Logging ↻

Status Basic Config Actions

Default Event Rule

Event Rule

### Event Rule

Search

Add ... Delete

Name	Description	Local	Priority	Syslog Facility	Syslog	SNMP Notification
cell_connected		true	notice	user	false	false
cell_disconnected		true	notice	user	false	false

Showing 1 to 2 of 2

Default Alarm Output

Alarm Output

Syslog

Click on **Add...** and the *Event Rules Details* option will appear.

### Event Rule Details

Name\*

Add Cancel

Click on the button to the right of the Name field to locate the event rule to configure. This will automatically bring up the popup shown on the previous page.



Default Event Rule

Name	Description	Local	Priority	Syslog Facility	Syslog	SNMP Notification
<input type="checkbox"/> LN_cal	NIC calibration alert	true	alert	user	true	true
<input type="checkbox"/> OneTimePassword	One-Time-Password activity	true	notice	user	true	true
<input type="checkbox"/> OneTimePassword_Unset	One-Time-Password Unset	true	warning	user	true	true
<input type="checkbox"/> cell_connected	cell connection established	true	notice	user	true	true
<input type="checkbox"/> cell_disconnected	cell connection disconnected	true	notice	user	true	true
<input type="checkbox"/> cell_recovery	cell recovery initiated	true	notice	user	true	true
<input type="checkbox"/> cell_roaming_change	cell roaming state changed	true	notice	user	true	true
<input type="checkbox"/> cell_service_change	cell service state changed	true	notice	user	true	true
<input type="checkbox"/> cell_sim_change	cell sim state changed	true	notice	user	true	true
<input type="checkbox"/> console_login		true	notice	user	true	true

OK Cancel

Once selected, click the **OK** button to close the popup and then click on the **Add** button when finished.

**Event Rule Details**

Name\*  ...

Add Cancel

Clicking on the add button will display the *Event Rule Details* option. Clicking the **Finish** button will add the event rule.

**Event Rule Details**

Description

Local

Priority

Syslog Facility

Syslog

SNMP Notification

NETCONF Notification

Alarm

Alarm Outputs

Finish

From the CLI this modification can be made with the commands:

```
% set logging event-rule cell_disconnected local true
% set logging event-rule cell_connected local true
```



## NETCONF-notifications

The events generated by the unit are converted to NETCONF notifications. NETCONF clients can subscribe to the unit to receive those notifications.

### Syslog Server Setup

The events generated by the unit can be sent to remote syslog servers. The connection to the syslog server can be made secure using syslog over TLS.

For example:

#### Logging

The screenshot shows the configuration page for Syslog servers. The 'Server' section contains a table with the following data:

Name	IP	Port	Version	Protocol	TLS CA Certificate	TLS Client Certificate
my_server	192.168.1.200	514	RFC3164	udp		

Below the table, the 'Message Format' is set to 'json\_cee'.

- **Name** - User supplied unique name to identify this server configuration
- **IP** - The hostname or IPv4 address of the syslog server.
- **Port** - The port to connect to. DEFAULT =514
- **Version** - The syslog protocol version to use. RFC3164 (DEFAULT) or RFC5424
- **Protocol** - The transport protocol used to send syslog messages to this server. Choices: tcp, udp, tls, tcp6, udp6, tls6
- **Message Format** – Choose either json\_cee or text <insert more info here>

If the TLS protocol is selected the following fields may be filled in:

- **TLS CA Certificate** - The name of the certificate of the CA server that was used to sign the certificate that the syslog server will be using.
- **TLS Client Certificate** - The client certificate to use when communicating to the syslog server over TLS.
- **TLS Client Key** - The name of the private key

To set up a syslog server, use the command:

```
% set logging syslog server my_server ip 192.168.1.200
```

### Alarms

Events can be configured by Event Rules to be Alarms which can causes the Power Light and external signal to go “high” state. Refer to Section 2.5 for further details.

Alarms have factory default settings that control the behavior of the alarm outputs timing in terms of period and duration. These values can be overridden to adjust for local requirements.



From the Web UI at *Logging ---> Basic Config* scroll down to **Default Alarm Output**.

## Logging

Name	Signal Period	Signal Duration
BOOT_ERROR	0	0
COM1_PIN	0	0
POWER_LED	1000	500

Modification of the alarm behavior can be adjusted adding entries to the **Default Alarm Output** table.

## Clearing the Event Log

The user may explicitly clear the event log. To clear the event log, navigate to *Logging ---> Actions / Clear Event Log* and click on the **Perform Action** button.

## Logging

Clear Event Log

Perform action

**Figure 3-73. Clear Event Log**

The following example shows how to clear the event log from the CLI:

```
> request logging clear-event-log
```

## Exporting the Event Log

The following example shows how to have the device generate an exportable event log and download that log to a local file through the web browser.

Navigate to *Logging ---> Actions / Export Event Log*

Click on the **Begin Generating** button once the file destination is configured.



## Logging ↻

Status Basic Config Actions

Clear Event Log  
Export Event Log

### Export Event Log

File Destination \*

- To Local File
- To Local File
- To FTP Server
- To TFTP Server
- To SFTP Server

Begin Exporting

**Figure 3-74. Export Event Log**

The MCR supports file downloads through a web browser to a local file on the user's PC. The MCR also supports FTP, TFTP, and SFTP file uploads using external remote servers.

- **File Destination** - File transfer method to use. Available choices are To Local File (DEFAULT), To FTP Server, To TFTP Server, and To SFTP Server. Local file downloads are only available through the web UI and not through the CLI
- **Server Address** - For FTP, TFTP, and SFTP, the remote server's host name or IP address
- **File Path** - For FTP, TFTP, and SFTP, the path to the destination file on the remote server
- **User Name** - For FTP and SFTP, the user name on the remote server
- **Password** - For FTP and SFTP, the password on the remote server
- **Control Port** - For FTP, the TCP control port (advanced setting - use default)
- **Data Port** - For FTP, the TCP data port (advanced setting - use default)
- **Block Size** - For TFTP, the block size as defined in RFP 2348 (advanced setting - use default)
- **Timeout** - For FTP, TFTP, and SFTP, the timeout in seconds (advanced setting - use default)

The following example shows how to have the device generate and transfer an exportable event log (named event-log-2016-02-04.xml) to a TFTP server running on a host (address 192.168.1.10) that is accessible from the MCR (e.g. a locally connected host or remote host accessible via cellular interface). To start the event log export from the CLI, enter the following command to upload the log file to an external TFTP server:

```
> request logging export-event-log filename event-log-2016-02-04.xml manual-file-server {  
  tftp { address 192.168.1.10 } }
```

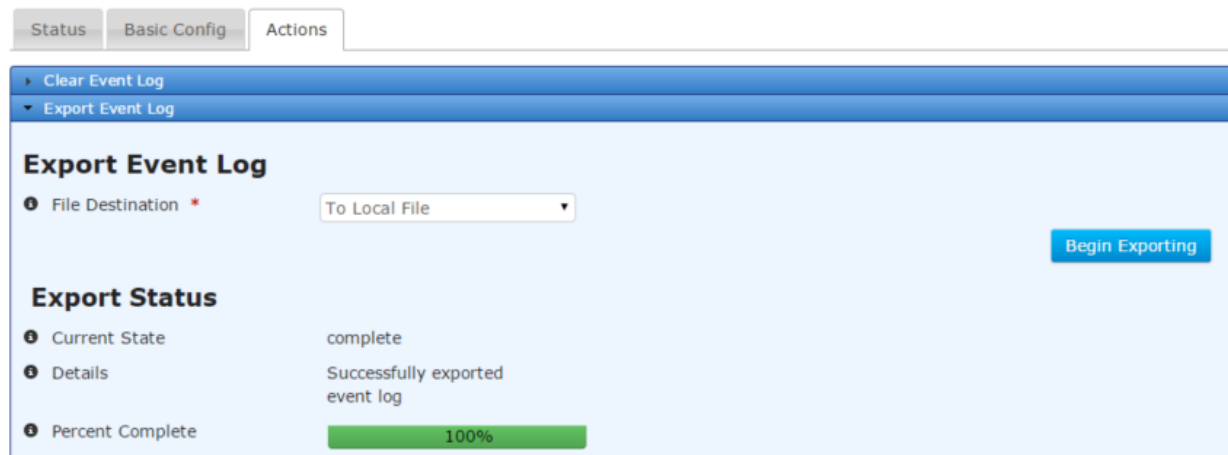
## Monitoring

Once the export of the event log is begun, the process may be cancelled by clicking the **Cancel Exporting** button. The current status of the export process is displayed on the web page. Note that the web page does not display the current status if the device has not been instructed to export an event log (in other words, if the state is “inactive”).





## Logging [↗](#)



**Figure 3-75. Export Event Log Monitoring**

The export status contains the following items:

- **Current State** – The status of the export event log task:
  - inactive
  - preparing
  - transferring
  - cancelling
  - complete
  - failure
  - cancelled
- **Detailed Message** – The details regarding the operation, such as “*Generating event log*”
- **Size** – The total number of bytes in the file (not displayed on the web UI)
- **Bytes Transferred** – The number of bytes already generated or transferred (not displayed on the web UI)
- **Percent Complete** – The percentage complete for the operation

To view the status of the process in the CLI, ensure the CLI is in operational mode and then follow the example below:

```
> show logging export-event-log-status
logging export-event-log-status state complete
logging export-event-log-status detailed-message “Successfully exported event log”
logging export-event-log-status size 345158
logging export-event-log-status bytes-transferred 345158
logging export-event-log-status percent-complete 100
```

### 3.6.3 Iperf Server Service

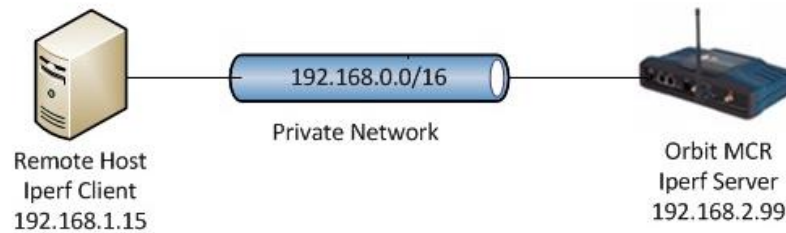
#### Understanding

Iperf is an open source network testing tool that measures throughput by sending and receiving data streams. Typically, a remote host acts as an iperf client, sending data streams to an endpoint, which acts as an iperf server.



The MCR includes an iperf service that allows the unit to receive TCP traffic from a remote host running iperf. Currently, iperf service is hardcoded to act only as a TCP server listening on port 5001.

As an example, consider the simple private network below. The system administrator would like to test throughput from the host at 192.168.1.15 to the Orbit MCR at 192.168.2.99. To do so, she enables the iperf service on the Orbit MCR, which runs as an iperf server. She then starts an iperf client on the remote host, and configures it to send TCP data streams to the Orbit MCR. The iperf client on the remote host then receives replies from the MCR and calculates the throughput of the network. Iperf is a tool that can be used to measure both TCP and UDP performance on a network. Iperf allows a user to set parameters that can test a network. Iperf reports bandwidth, delay jitter, datagram loss. This unit incorporates a Iperf server that can be utilized by an external client.



**Figure 3-76. Setup using iperf for throughput testing in a private network**

Iperf features:

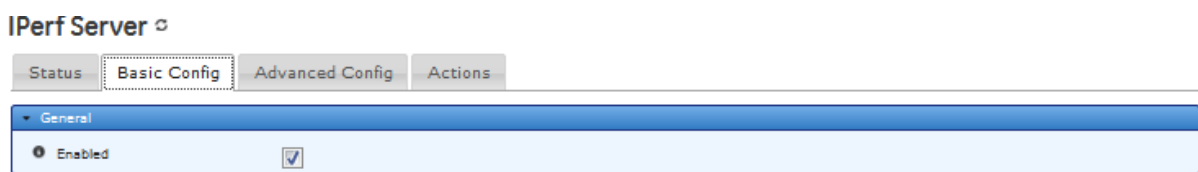
- TCP
  - Measure bandwidth
  - Report MSS/MTU size and observed read sizes.
  - Support for TCP window size via socket buffers.
  - Multi-threaded if pthreads or Win32 threads are available. Client and server can have multiple simultaneous connections.
- UDP
  - Client can create UDP streams of specified bandwidth.
  - Measure packet loss
  - Measure delay jitter
  - Multicast capable
  - Multi-threaded if pthreads are available. Client and server can have multiple simultaneous connections (this doesn't work in Windows).

Iperf is available on many platforms, and there are also open source graphical front-ends available. For further information on iperf, see the iperf homepage at <http://software.es.net/iperf/>.

Enabling the Iperf service allows the unit to receive TCP traffic from remote host running iperf. Currently, iperf service running v2.0.5 and is hardcoded to act only as a TCP server listening on port 5001.

## Configuring

The following shows how to enable iperf service – *Services / Iperf Server ---> Basic Config*:



**Figure 3-77. Iperf Enable Screen**



From the CLI the command is:

```
% set services iperf enabled true
```

**NOTE** If firewall is enabled, then it must be configured to permit incoming TCP traffic on port 5001.

## Monitoring

From the Services Screen the iPerf status can be checked by navigating to *IPerf Server*

```
> show services
NAME          STATUS
-----
DHCP Server   running
Firewall      running
IPerf Server  running
NETCONF Server running
Quality of Service running
Serial        running
SNMP Server   running
SSH Server    running
VPN           disabled
Web Server    running
```

### 3.6.4 Snapshots and System Recovery

#### Understanding

A “snapshot” stores the unit’s configuration at the time the snapshot was taken. At any time, you may roll back the unit’s settings to those contained in a specific snapshot. You may also choose which firmware image to reboot to once the snapshot is restored. Take note that restoring the unit to a snapshot will overwrite the current configuration, and that it cannot be undone.

Three types of snapshots exist on an Orbit MCR: Factory, Automatic, and user snapshots.

- The Factory snapshot is the configuration with which the unit shipped. Rolling back to this snapshot is equivalent to performing a factory reset. Note that passwords will be reset to their default values.
- The Automatic snapshot is automatically generated after the unit boots to a new version of firmware. Rolling back to this snapshot will modify configuration, but does not modify passwords.
- Up to two user snapshots can be created by a user with *admin* privileges. These can be created or deleted at any time. Rolling back to these snapshots will modify configuration, but does not modify passwords.

Use the table below as a quick reference to the capabilities of each type of snapshot.

Snapshot type	User can modify?	Resets passwords?
Factory	No	Yes
Auto	No	No
User	Yes	No



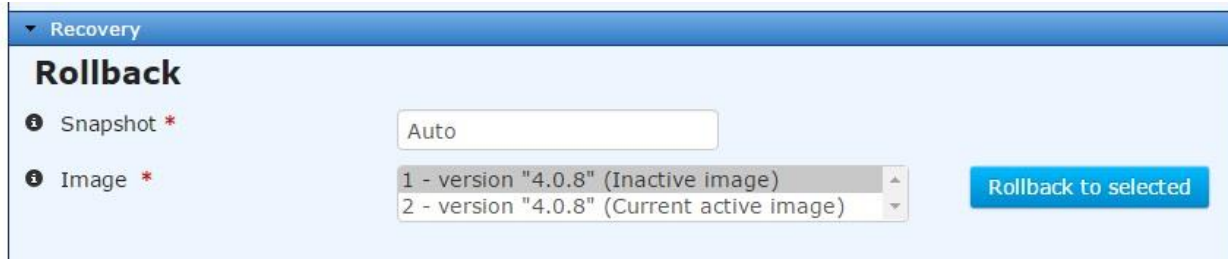
## Configuration

### Using the WebUI

Navigate to *System->Troubleshooting* and click the **Actions** tab.

#### Rollback to a snapshot

To rollback to one of the unit's snapshots, first expand the **Recovery** menu.



**Figure 3-78 Rollback menu**

The **Snapshot** dropdown box lists all the snapshots available on the device. Select the desired snapshot, and the image that you wish to reboot to.

Initiating a rollback operation immediately reboots the unit to the specified firmware image and restores the unit's configuration to the specified snapshot. This operation cannot be undone.

#### Managing user snapshots

The **User Snapshots** menu, found under the **Rollback** menu, allows you to create, delete, and set the default user snapshot. You cannot delete or modify the unit's Factory or Auto snapshots.

You may create up to two user snapshots. These snapshots contain the system's current configuration and can be rolled back to at any time. User snapshots do *not* restore passwords. You can also specify a default user snapshot. The system may use the default user snapshot as a recovery point in the event that the unit fails to boot properly.



▼ User Snapshots

### Create Snapshot

**i** Identifier \*

**i** Description

**i** Default

**Perform action**

### Delete Snapshot

Identifier \*

**Perform action**

### Set Default Snapshot

Identifier \*

**Perform action**

Figure 3-79 User Snapshots menu.

#### Create Snapshot

- **Identifier** – The name of the user snapshot. Up to 30 characters, including letters, numbers, dashes, underscores, and spaces.
- **Description** - Description of this user snapshot. Up to 127 characters, including letters, numbers, dashes, underscores, and spaces. Optional.
- **Default** - Set the default user snapshot used in error recovery. Optional.

#### Delete Snapshot

- **Identifier** – The user snapshot to delete. Once a snapshot is deleted, it cannot be recovered.



## Set Default Snapshot

- **Identifier** – The user snapshot that should be used by the system as a recovery point if the unit fails to boot properly due to a configuration issue.

## Status

Navigate to *System->Troubleshooting->Status*.

## Troubleshooting

Status

Actions

▼ Recovery Information

### Snapshots

⌵
↺
👁
🔍
✎

Identifier	Description	Date	Version	Hash	User Default
Factory	Factory Default Configuration	2013-01-01T00:14:27+00:00	4.0.0	0x158debb6d7eac2068166370ace53581	false
Snapshot1	User-created snapshot	2016-01-12T19:17:22+00:00	4.5.5	0x9bafb1d33b6b14fa24d19002caf967fd	false
Auto	Automatic snapshot for 4.0.8	2016-01-12T19:20:18+00:00	4.0.8	0x9bafb1d33b6b14fa24d19002caf967fd	false

Showing 1 to 3 of 3

### Passwords

⌵
↺
👁
🔍
✎

Identifier	Function	Status	Date Created	Date Revoked	User
Table is empty					

**Figure 3-80 Snapshots status menu**

- **Identifier** – The snapshot’s name.
- **Description** – The snapshot’s description.
- **Date** – This is the date that the snapshot was created.
- **Version** – This is the firmware version that the unit was running at the time the snapshot was created.
- **User Default** - Specifies the default user snapshot used in error recovery.

## Using the CLI

### Rollback to a snapshot

You can rollback to one of the unit’s snapshots in either operational or configuration mode.

Use the following command to rollback the unit to the configuration stored in the Auto snapshot, and reboot to the current active image.



```
% request system recovery rollback snapshot Auto which-image { active }
```

The system will prompt you for confirmation before the unit proceeds with the operation. Once confirmed, the rollback cannot be undone.

The current system configuration will be erased and replaced with the snapshot.  
Proceed? [no,yes]

## Managing user snapshots

You can create, delete, and set the default user snapshot in either operational or configuration mode.

Use the following command to create a user snapshot named Snapshot1 and set it as the default user snapshot.

```
% request system recovery user-snapshots create identifier Snapshot1 description  
"Example snapshot" default true
```

The following command deletes the specified user snapshot.

```
% request system recovery user-snapshots delete identifier Snapshot1
```

You can set an existing snapshot as the default user snapshot with the following command.

```
% request system recovery user-snapshots set-default identifier Snapshot1
```

## Monitoring

To view the device's snapshots, ensure that the CLI is in operational mode.

```
% show system recovery snapshot  
system recovery snapshots Factory  
  description "Factory Default Configuration"  
  date        2013-01-01T00:14:27+00:00  
  version     4.0.0  
  hash        0x158debb6d7eaec2068166370ace53581  
  user-default false  
system recovery snapshots Auto  
  description "Automatic snapshot for 4.0.8"  
  date        2016-01-13T17:20:54+00:00  
  version     4.0.8  
  hash        0xa13ceb2d5d267341d5067d975e39131e  
  user-default false  
system recovery snapshots Snapshot1  
  description "Example snapshot"  
  date        2016-01-13T19:53:44+00:00  
  version     4.5.5  
  hash        0x579b9fa00303ceb9eeb3981cc429d31b  
  user-default true
```



## 3.6.5 Support Bundle

### Understanding

Orbit MCR incorporates a facility to generate support package bundles that includes internal debug messages, logs, and other helpful pieces of information. These items can help factory personnel troubleshoot user issues.

### Configuring

The following example shows how to have the device generate a support package bundle and download that bundle to a local file through the web browser.

Navigate to *System / Troubleshooting ---> Actions / Support Package*

Click on the **Begin Generating** button once the file destination is configured.



**Figure 3-81. Support Package**

The MCR supports file downloads through a web browser to a local file on the user's PC. The MCR also supports FTP, TFTP, and SFTP file uploads using external remote servers.

- **File Destination** - File transfer method to use. Available choices are To Local File (DEFAULT), To FTP Server, To TFTP Server, and To SFTP Server. Local file downloads are only available through the web UI and not through the CLI
- **Server Address** - For FTP, TFTP, and SFTP, the remote server's host name or IP address
- **File Path** - For FTP, TFTP, and SFTP, the path to the destination file on the remote server
- **User Name** - For FTP and SFTP, the user name on the remote server
- **Password** - For FTP and SFTP, the password on the remote server
- **Control Port** - For FTP, the TCP control port (advanced setting - use default)
- **Data Port** - For FTP, the TCP data port (advanced setting - use default)
- **Block Size** - For TFTP, the block size as defined in RFP 2348 (advanced setting - use default)
- **Timeout** - For FTP, TFTP, and SFTP, the timeout in seconds (advanced setting - use default)

The following example shows how to have the device generate and transfer a support package bundle (named debug-2016-02-04.tgz) to a TFTP server running on a host (address 192.168.1.10) that is accessible from the MCR (e.g. a locally connected host or remote host accessible via cellular interface). To start the support package bundle generation from the CLI, enter the following command to upload the bundle to an external TFTP server:

```
> request system support-package generate filename debug-2016-02-04.tgz manual-file-server { tftp { address 192.168.1.10 } }
```

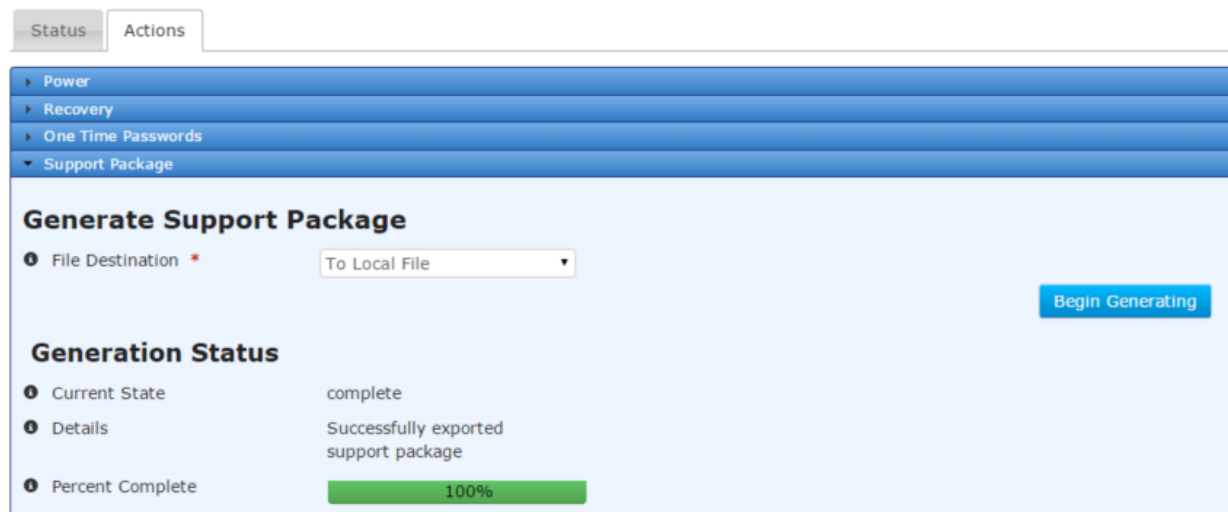




## Monitoring

Once the generation of a support package bundle is begun, the process may be cancelled by clicking the **Cancel Generation** button. The current status of the generate support package process is displayed on the web page. Note that the web page does not display the current status if the device has not been instructed to generate a support package bundle (in other words, if the state is “inactive”).

## Troubleshooting



**Figure 3-82. Support Package Monitoring**

The generation status contains the following items:

- **Current State** – The status of the generate support package bundle task:
  - inactive
  - preparing
  - transferring
  - cancelling
  - complete
  - failure
  - cancelled
- **Detailed Message** – The details regarding the operation, such as “*Generating support package*”
- **Size** – The total number of bytes in the package (not displayed on the web UI)
- **Bytes Transferred** – The number of bytes already generated or transferred (not displayed on the web UI)
- **Percent Complete** – The percentage complete for the operation

To view the status of the process in the CLI, ensure the CLI is in operational mode and then follow the example below:

```
> show system support-package generate-status
system support-package generate-status state complete
system support-package generate-status detailed-message "Successfully exported support
package"
system support-package generate-status size 2245680
system support-package generate-status bytes-transferred 2245680
```



## 3.7 System Configuration and Setup

### 3.7.1 Date, Time and NTP

#### Understanding

The date and time can be set on the unit using a manually configured value or automatically via Network Time Protocol (NTP). The NTP settings take precedence over the manual settings. If NTP is enabled, then the user will not be able to set the date and time manually.

The Orbit MCR provides the admin user the ability to increase the complexity of the configured user login passwords. User passwords can be configured to have a minimum length, a minimum amount of lower-case letters, a minimum amount of capital letters, a minimum amount of numeric characters and a minimum amount of non-alpha numeric values.

#### Configuring

##### Manual Setting of Date, Time and Timezone

To manually set the System Clock date and time on the webUI - Navigate as shown and set the date (using the calendar) , time (using the slider shown below) and timezone (offset from GMT) - Navigate to *System / Time ---> Actions / Set Current Datetime*:

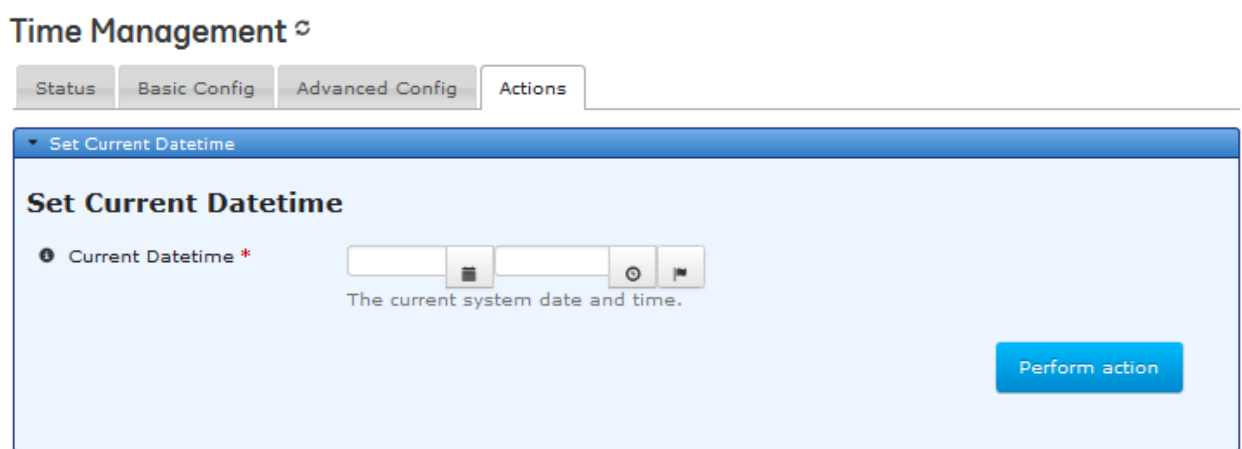


Figure 3-83. Set DateTime Screen

For setting the time use the sliders;

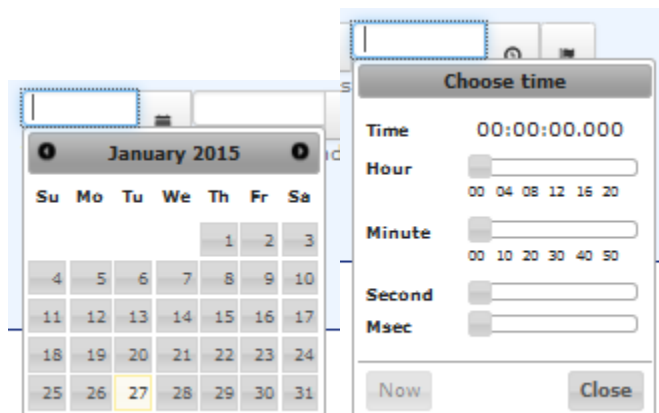


Figure 3-84. Set Date and Time Sliders Screen



The Time zone can be set on the clock page by selecting from a drop down location list or entering UTC Offset located to the right of the *Current Datetime* field or you can set the UTC location on the **Basic Config** tab as shown below;

## Time Management

Status Basic Config Actions

General

Timezone

Timezone

Choices

Timezone Location America/New\_York

NTP

To manually set the date and time, use the request set-current-datetime:

```
> request system clock set-current-datetime current-datetime 2013-10-01T8:33:45
```

## Automatic set using NTP or SNTP Server

To use an NTP server, the NTP settings on the Orbit MCR must be configured. From the Web UI - Navigate to the *System / Time* ---> **Basic Config / NTP**

## Time Management

Status Basic Config Actions

General

Timezone

NTP

Use NTP

Mode sntp

**NTP Server**

Search Add ... Delete

Address	Association Type	Enabled	Iburst	Prefer
10.15.60.10	server	true	false	false

Showing 1 to 1 of 1

Enable NTP or SNTP by clicking the **Use NTP** checkbox. Click on the Mode option to choose which type of time server desired; NTP or SNTP and then add a server configuration by clicking the **Add** button:



## Time Management [↻](#)

Status Basic Config Actions

General

Timezone

NTP

Use NTP

Mode

**NTP Server**

Search  Add ... Delete

Address	Association Type	Enabled	Iburst	Prefer
10.15.60.10	server	true	false	false

Showing 1 to 1 of 1

**Configure NTP Server Details**

Association Type

Enabled

Iburst

Prefer

Finish

- **Address** - IP address or domain name of the server
- **Association Type** - choices
  - Server - *most common* - An NTP server is configured to synchronize NTP clients. Servers will accept no synchronization information from their clients
  - Peer - each device shares its time information with the other, and each device can also provide time synchronization to the other
  - Pool - a large virtual cluster of timeservers providing reliable NTP service such as pool.ntp.org
- **Enabled** - Server enabled for use - *check* = True (DEFAULT)
- **Iburst** - perform burst synchronization *check* = True (DEFAULT)
- **Prefer** - Use as preferred server - *check* = True (DEFAULT)

### Automatic set using GPS

If the radio contains a GPS module and is connected to a functioning GPS signal, by default, the radio will sync time and date on the initial connection to the service.

## Time Management [↻](#)

Status Basic Config Actions

General

Sync with Gps Once

Timezone

NTP

From the CLI, the NTP settings on the Orbit can be configured:

```
% set system ntp use-ntp true mode ntp ntp-server time.nist.gov
```

To configure a SNTP server from the CLI, use the following command as an example;

```
% set system ntp use-ntp true mode sntp ntp-server server-address
```



Where the **server-address** corresponds to the desired server IP address.

All time on the device is defaulted to UTC (+0:00) time. Time that is gained by an NTP server will be offset by the difference to UTC time. To properly ensure that the date and time reflected on the unit is correctly displayed, configure the time offset in respect to location or manually.

From the CLI, to manually set the time offset, enter the offset in increments of 30 minutes. For example, to enter -5 hours for the UTC offset:

```
% set system clock timezone-utc-offset -300
```

Manually setting the time offset will not take in account daylight savings. To set the time based on location; choose the location based closest to the installation site. For New York, the offset is -5 hours during daylight savings and will automatically become -4 hours when daylight savings ends.

```
% set system clock timezone-location America/New_York
```

## Monitoring

Ensure the CLI is in operational mode. Follow the example below to view the state and statistics:

```
> show system clock
system clock current-datetime 2012-06-19T00:20:34+00:00
system clock boot-datetime 2012-06-19T00:18:01+00:00
```

### 3.7.2 Geographical-location

The geographical-location of the unit can be manually. This information can be configured using the initial setup wizard.

- **Latitude** - in degrees
- **Longitude** - in degrees
- **Altitude** - in meters

From the CLI:

```
% set system geographical-location altitude 1.0 latitude 43.117807 longitude -77.611896
```

### 3.7.3 User Management and Access Controls

#### Understanding

There are three user accounts/roles (administrator, technician and operator) for management access.

Users in the *admin* group have the highest privilege and can read everything in the tree that is readable, write everything that is writable and can execute any of the requests.

Users in the *tech* group have less access than admin. Generally, the tech group cannot configure any security-related configuration.

Users in the *oper* group can only view status and configuration. They do not have access to modify the device configuration.

By default, the password for each account is the same as the username. Passwords should be changed by users prior to deploying the device. For added security, the *tech* and *oper* accounts are disabled until their respective passwords are changed. They can also be manually disabled.

When local user management is being used, passwords are stored in non-volatile memory using PKCS#5 based encryption.

User authentication is performed using either locally stored passwords or RADIUS.



## Configuring

Changing the password is accomplished by navigating to *System / User Authentication ---> Actions / Change Password*

Select the user from the dropdown list (as shown) and enter the password desired.

The password for each user account can also be changed using a CLI request:

```
> request system authentication change-password user admin password new_password
```

**NOTE** If the admin password is forgotten, the method to recover the unit is by using the login One-Time-Password. This will give the user the ability to change the forgotten password. See “One-Time “Recovery” Passwords” on Page 39.

Orbit user authentication provides the capability to manage the rules regarding logins and the setup rules regarding password strength.

The unit has protections against repeated login attempts. The max-login-attempts configuration determines the number of failed logins that can occur in succession before the unit disables the ability to login for a specified amount of time. The amount of time is determined by failed-login-lockout-time, which represents the time in seconds.

Start by viewing the current users at *System / User Authentication ---> Status*

- **Group Memberships** -A list of groups the current user is a member of.

To configure the password options navigate to the *Basic Config* tab.



## User Authentication

Status	Basic Config	Actions
▼ General		
● Max Login Attempts	<input type="text" value="4"/>	
● Failed Login Lockout Time	<input type="text" value="300"/>	seconds
● User Authentication Order	<input type="text" value="Sys Local Users x"/> Add an entry ...	
● Disable Non Admin Users	<input type="checkbox"/>	

- **Max Login Attempts** - The maximum number of failed login attempts before locking out future attempts. DEFAULT 4
- **Failed Login Lockout**- The number of seconds to reject further login attempts from a host who has failed to login 'max-login-attempts' number of times. DEFAULT 300 (5 minutes)
- **User Authentication Order** - When the device authenticates a user with a password, it tries the authentication methods in this list in order. If authentication with one method fails, the next method is used. If no method succeeds, the user is denied access. DEFAULT Local Users only.
  - Radius
  - Sys Local Users
- **Disable Non Admin Users** – Indicates whether or not *tech* and *oper* accounts are disabled. DEFAULT false (Note: these are automatically disabled until default password is changed)

From the CLI these parameters may be set:

```
% set system max-login-attempts 30  
% set system failed-login-lockout-time 300  
%set system authentication disable-non-admin-users true
```

To configure password rules Navigate to *System / User Authentication* ---> *Basic Config / Password Options*

## User Authentication

Status	Basic Config	Advanced Config	Actions
▶ General			
▼ Password Options			
● Minimum Length	<input type="text" value="4"/>		
● Minimum Lower Case Letters	<input type="text" value="1"/>		
● Minimum Capital Letters	<input type="text" value="1"/>		
● Minimum Numeric	<input type="text" value="1"/>		
● Minimum Non Alpha Numeric	<input type="text" value="0"/>		

- **Minimum Length** - The minimum number of characters that must be in a password. DEFAULT= 8
- **Minimum Lower Case Letters** - The minimum number of lower-case letters ([a-z]) that must be in a password. DEFAULT 1 read-write uint16 1 No



- **Minimum Capital Letters** - The minimum number of capital letters ([A-Z]) that must be in a password. DEFAULT 1
- **Minimum Numeric** - The minimum number of numeric characters ([0-9]) that must be in a password. DEFAULT 1
- **Minimum Non Alphanumeric** - The minimum number of non alpha-numeric characters that must be in a password. Non alpha-numeric characters are defined as any character that does not match the pattern [a-zA-Z0-9].DEFAULT 0

User authentication order can be specified to give preference to which method is used first when authenticating user access. In the following example, the list of RADIUS servers will be contacted first before the local authentication rules are used.

**NOTE** If the local-users option is specified *before* RADIUS, then only the local-users option will be utilized; the RADIUS servers will never be contacted.

**% set system authentication user-authentication-order [radius local-users]**

## Monitoring

Navigate to **Logging**. Scroll Down to **Event Log**. Click on the magnifier to filter the data. Default is “*ID is {nothing}*” Each portion is adjustable to tailor the search. For example to find all web\_login events set up the filter as shown.

Results of the search may resemble the following:

## Logging

Status Basic Config Advanced Config Actions

Current Alarms

Event Log

Event Log

Search

ID	Time Stamp	Priority	Event Type	Status	Message
185	2014-11-26T11:35:14.740898-05:00	notice	web_login	success	action login, service web, src_ipv4 10.1...
181	2014-11-26T11:14:43.879201-05:00	notice	web_login	success	action login, service web, src_ipv4 10.1...
176	2014-11-26T11:10:57.237425-05:00	notice	web_login	success	action login, service web, src_ipv4 10.1...
40	2014-11-26T11:26:58.476299-05:00	notice	web_login	success	action login, service web, src_ipv4 10.1...
35	2014-11-26T11:17:49.252097-05:00	notice	web_login	success	action login, service web, src_ipv4 10.1...
13	2014-11-26T13:25:14.405834-05:00	notice	web_login	success	action login, service web, src_ipv4 10.1...
7	2014-11-26T13:10:47.351796-05:00	notice	web_login	success	action login, service web, src_ipv4 10.1...
6	2014-11-26T13:08:41.338586-05:00	notice	web_login	success	action login, service web, src_ipv4 10.1...

Showing 1 to 8 of 8





Clicking on the event Id number provides detailed information regarding record. In the following example the user logged in the web from IP4 address 192.168.1.10, on port 49656 as user admin:

^ 395	
Time Stamp	Wed, 13 Aug 2014 23:15:39 GMT
Priority	notice
Event Type	web_login
Status	success
Message	action login, service web, src_ipv4 192.168.1.10, src_port 49656, user_name admin,

To do similar operations from the CLI in operational mode, follow the example below to see the history of login attempts by reviewing the event log:

```
> show logging event-log event-type web_login
logging event-log 62625
time-stamp 2011-12-21T01:18:08.985996+00:00
priority notice
event-type web_login
status success
message "user_name oper, "
logging event-log 62627
time-stamp 2011-12-21T01:23:00.288046+00:00
priority notice
event-type web_login
status failure
message "msg noauth, user_name admin, "
```

### 3.7.4 RADIUS User Management

#### Understanding

User accounts can be centrally managed with a RADIUS server. RADIUS accounts can be mapped to one of the three user roles.

If the RADIUS server is not accessible, users may use the local username/password to “fall back” to local authentication if the unit is configured to do so. Many RADIUS servers do not respond to an invalid login attempt. To the unit, this appears the same as if the server is not there. The consequence of this behavior is that after three (default setting) failed login attempts, the authentication will take place against the local user/password database if local fallback is enabled. Refer to the section on “Local User Management” for configuring the authentication order.

If more than one RADIUS server is configured, then the unit will attempt each RADIUS server in the order that they appear in the configuration until a successful response is received. A RADIUS server must be configured to provide the user’s authentication group in its authentication reply via a GE MDS vendor attribute.

This can be configured in FreeRADIUS (an open source RADIUS server) by creating a dictionary file (placed usually in C:/FreeRADIUS.net/share/freeradius) with the following information:

```
VENDOR GEMDS 4130
BEGIN-VENDOR GEMDS
ATTRIBUTE GEMDS-UserAuth-Group 1 integer
VALUE GEMDS-UserAuth-Group Operator 0
VALUE GEMDS-UserAuth-Group Technician 1
VALUE GEMDS-UserAuth-Group Administrator 2
END-VENDOR GEMDS
```



And configure the users.conf file (typically found in C:/FreeRADIUS.net/etc/raddb) as follows:

```
admin Cleartext-Password := "admin"
    GEMDS-UserAuth-Group := Administrator

tech Cleartext-Password := "tech"
    GEMDS-UserAuth-Group := Technician

oper Cleartext-Password := "oper"
    GEMDS-UserAuth-Group := Operator
```

Syntax may differ from one RADIUS server platform to another. Configurations for a commercial Linux server, such as the AAA server from Interlinks Network, its dictionary file may be similar to the following:

```
GEMDS.attr  GEMDS-UserAuth-Group    1  integer (1, 0, 0)
GEMDS.value GEMDS-UserAuth-Group    Administrator    2
GEMDS.value GEMDS-UserAuth-Group    Technician      1
GEMDS.value GEMDS-UserAuth-Group    Operator        0
```

The following line is required to be added to the vendors file:

```
GEMDS.attr  GEMDS.value    4130    GEMDS
```

And configuring users as follows:

```
admin Password = "admin"
    GEMDS: GEMDS-UserAuth-Group = "2"
tech Password = "tech"
    GEMDS: GEMDS-UserAuth-Group = "1"
oper Password = "oper"
    GEMDS: GEMDS-UserAuth-Group = "0"
```

---

**NOTE** All approved networked devices are required to be identified in the server's client file.

---

## Configuring

Navigate to: *System / User Authentication ---> Basic Config / RADIUS* the main interface for adding RADIUS servers.

### User Authentication

The screenshot shows the 'User Authentication' configuration page. It has tabs for 'Status', 'Basic Config', 'Advanced Config', and 'Actions'. The 'Basic Config' tab is active. Underneath, there are sections for 'General', 'Password Options', and 'RADIUS'. The 'RADIUS' section is expanded to show 'Servers'. There is a search box, 'Add ...', 'Delete', and 'Move' buttons. A table with columns 'Name', 'Address', 'Authentication Port', 'Shared Secret', 'User Authentication Type', and 'Nas Address' is present, with a note 'Table is empty'. Below the table are input fields for 'Timeout' (value 5) and 'Attempts' (value 2).

- **Timeout** - The number of seconds the device will wait for a response from a RADIUS server before trying with a different server. Default = 5 - max value 255.



- **Attempts** - The number of times the device will send a query to the RADIUS servers before giving up. Default = 2 - max value 255.

Click the **Add** button and add a server.

## User Authentication ↻

Status Basic Config Advanced Config Actions

General  
Password Options  
RADIUS

**Servers**

Search  Add ... Delete Move ▾

Name	Address	Authentication Port	Shared Secret	User Authentication Type	Nas Address
server1	192.168.1.2	1812	abcd1234	mdssys:radius-CHAP	192.168.1.100

Showing 1 to 1 of 1

Timeout

Attempts

- **Name** – User defined name for the server.
- **Address** - The IPV4 address of the RADIUS server. Alternative entry is to use a “Domain Name” string
- **Authentication Port** - The port number of the RADIUS server. Default =1812
- **Shared Secret** - The shared secret which is known to both the RADIUS client and
- **User Authentication Type** - The authentication type used by the RADIUS server.
- **Nas Address** - The IPV4 address provided in the NAS address attribute of the radius request. This should be the address of the interface that is making the request. If it is not provided the system will determine the address automatically. Alternative entry is to use a “Domain Name” string

From the CLI command line, the following shows how to configure a RADIUS server on the MCR radio:

```
% set system mds-radius servers server1 address 192.168.1.2 shared-secret abcd1234 user-
authentication-type radius-CHAP nas-address 192.168.1.100
```

```
% show system mds-radius
servers server1 {
    address                192.168.1.2;
    authentication-port    1812;
    shared-secret          abcd1234;
    user-authentication-type radius-CHAP;
    nas-address            192.168.1.100;
}
```

### 3.7.5 Firmware Management

#### Understanding

GE periodically releases new Orbit MCR/ECR device firmware to provide new features and important updates. Firmware is provided at:

[http://www.gegridsolutions.com/Communications/MDS/software.asp?directory=Orbit\\_MCR](http://www.gegridsolutions.com/Communications/MDS/software.asp?directory=Orbit_MCR)



The unit can have two firmware packages programmed into the device. The package that the device booted into is referred to as the *Active Firmware*. The other image is referred to as the *Inactive Firmware*.

To reprogram the device, the Active Firmware transfers the new firmware package from the network and writes the package into the Inactive Firmware location in memory. To use the new firmware package, the user must reboot the device to the Inactive Firmware. Doing so will make the Inactive Firmware the Active Firmware and vice-versa.

Firmware packages released by the factory are digitally signed using a private key. The unit will not accept firmware packages that are unsigned nor will it accept firmware packages that fail to verify while using the public certificates loaded into the device. Therefore it is necessary to have the GE MDS public certificate loaded into the device to reprogram the firmware.

Users may add their own signatures to the firmware package using the GE MDS code signing tool.

---

**NOTE** Any additional signatures added to a firmware package will require the corresponding public certificates to be loaded into the unit for firmware reprogramming to complete successfully. Similarly, any additional firmware-validation public certificates loaded into the unit require a firmware package to be signed with the corresponding private keys.

---

From the WebUI, navigate to *System / Firmware*. The Versions section shows the firmware currently loaded in the two regions and which region is active.

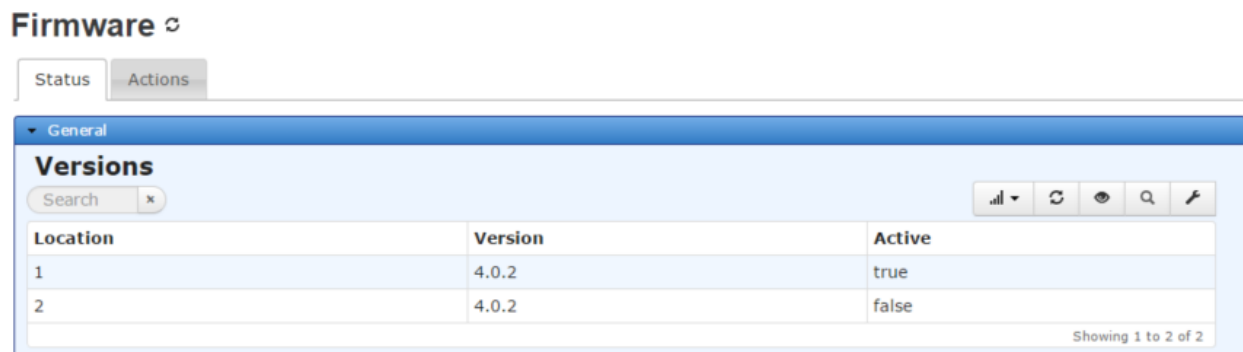


Figure 3-85. Firmware Versions Screen

## Monitoring

Ensure the CLI is in operational mode. Follow the example below to view the state and statistics of the currently installed firmware packages.

```
> show system firmware versions
system system firmware versions 1
version 4.0.2
active true
signatures 1
certificate-sha256
3d9d795dcf374084de536986a29238ea7dc87104259619bc7aa4cfa3e2c64990
system firmware versions 2
version 4.0.2
active false
signatures 1
certificate-sha256
3d9d795dcf374084de536986a29238ea7dc87104259619bc7aa4cfa3e2c64990
```



## Actions

Navigating to the *Actions* tab, the following options are now available for firmware maintenance.



**Figure 3-86. Firmware Actions**

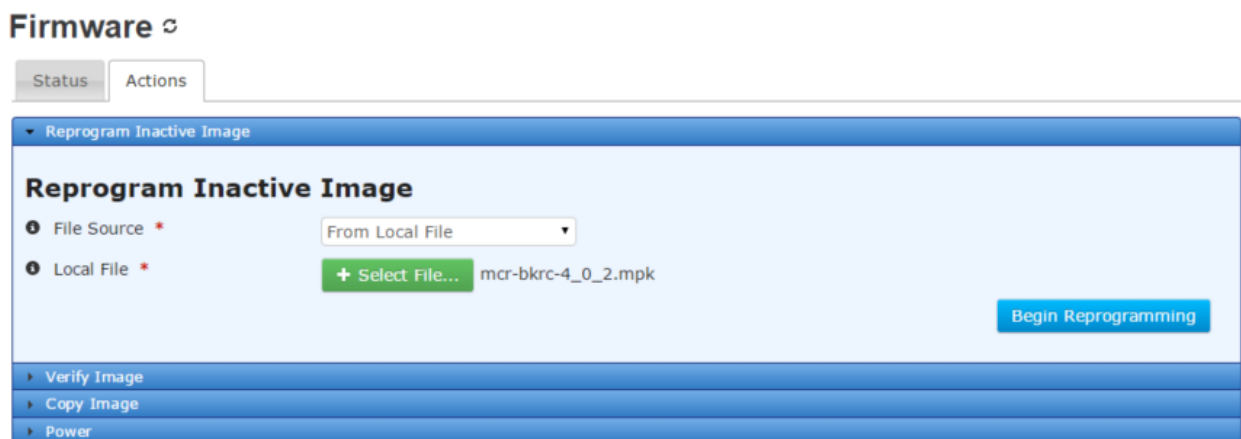
- **Reprogram Inactive Image** - Transfers a firmware package from the network and into the inactive firmware image
- **Verify Image** - Verify the integrity of a specified firmware image
- **Copy Image** - Copy the active firmware image to the inactive region. Eliminates the need to download the image more than once
- **Power** – Reboots the device to the specified firmware image

## Configuring - Reprogram

To start reprogramming the inactive firmware image, navigate to the **Reprogram Inactive Image** section. The following example shows how to upload a host firmware image file through the web browser and store the uploaded image file into the inactive region in memory.

Navigate to *System / Firmware* ---> *Actions / Reprogram Inactive Image*

Click on the **Begin Reprogramming** button once the file source is configured.



**Figure 3-87. Reprogram Inactive Image**

The MCR supports file uploads through a web browser from a local file on the user's PC. The MCR also supports HTTP, FTP, TFTP, and SFTP file downloads using external remote servers.

- **File Source** - File transfer method to use. Available choices are From Local File (DEFAULT), From HTTP Server, From FTP Server, From TFTP Server, and From SFTP Server. Local file uploads are only available through the web UI and not through the CLI
- **Local File** - For a local file, the file to upload as chosen by the file dialog popped up by the **Select File...** button



- **URL** - For HTTP, the location of the source file
- **Server Address** - For FTP, TFTP, and SFTP, the remote server's host name or IP address
- **File Path** - For FTP, TFTP, and SFTP, the path to the source file on the remote server
- **User Name** - For FTP and SFTP, the user name on the remote server
- **Password** - For FTP and SFTP, the password on the remote server
- **Control Port** - For FTP, the TCP control port (advanced setting - use default)
- **Data Port** - For FTP, the TCP data port (advanced setting - use default)
- **Block Size** - For TFTP, the block size as defined in RFP 2348 (advanced setting - use default)
- **Timeout** - For FTP, TFTP, and SFTP, the timeout in seconds (advanced setting - use default)

The following example shows how to have the device download a firmware image (named mcr-bkrc-4\_0\_2.mpk) from a TFTP server running on a host (address 192.168.1.10) that is accessible from the MCR (e.g. a locally connected host or remote host accessible via cellular interface). To start reprogramming the inactive firmware image from the CLI, enter the following command to download the firmware image from the TFTP server:

```
> request system firmware reprogram filename mcr-bkrc-4_0_2.mpk manual-file-server { tftp {  
  address 192.168.1.10 } }
```

## Monitoring - Reprogram

Once the reprogramming is begun, the process may be cancelled by clicking the **Cancel Reprogramming** button. The current status of the reprogramming process is displayed on the web page. Note that the web page does not display the current status if the device has not been instructed to reprogram (in other words, if the state is “inactive”).

### Firmware

The screenshot displays the 'Reprogram Inactive Image' monitoring interface. At the top, there are 'Status' and 'Actions' tabs. The main content area is titled 'Reprogram Inactive Image' and contains the following elements:

- File Source:** A dropdown menu currently set to 'From Local File'.
- Local File:** A field containing the filename 'mcr-bkrc-4\_0\_2.mpk' and a '+ Select File...' button.
- Begin Reprogramming:** A blue button to initiate the process.
- Reprogramming Status:**
  - Current State:** complete
  - Details:** Successfully reprogrammed host firmware
  - Percent Complete:** 100% (indicated by a green progress bar)
- Bottom Navigation:** Links for 'Verify Image', 'Copy Image', and 'Power'.

**Figure 3-88. Reprogram Inactive Image Monitoring**

The reprogramming status contains the following items:

- **Current State** – The status of the reprogramming task:
  - inactive
  - transferring
  - processing



- cancelling
- complete
- failure
- cancelled
- **Detailed Message** – The details regarding the operation, such as “*Transferring host firmware image*”
- **Size** – The total number of bytes in the image (not displayed on the web UI)
- **Bytes Transferred** – The number of bytes already transferred or processed (not displayed on the web UI)
- **Percent Complete** – The percentage complete for the operation

To view the status of the reprogramming process in the CLI, ensure the CLI is in operational mode and then follow the example below:

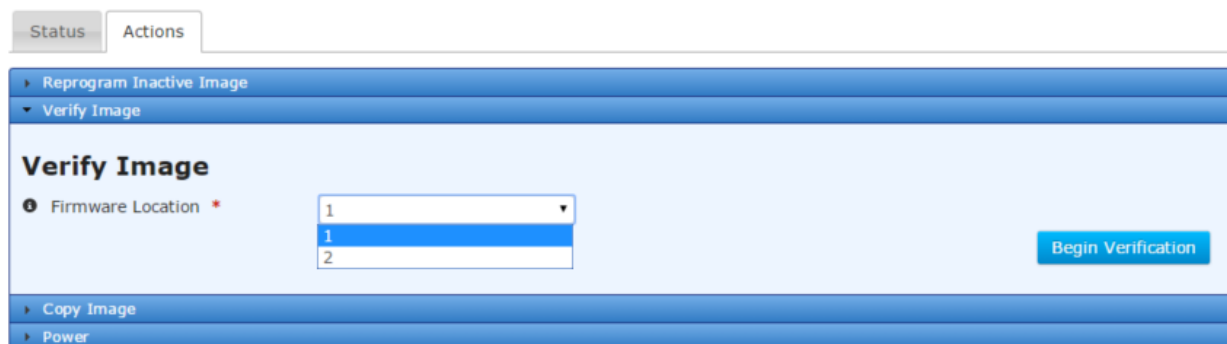
```
> show system firmware reprogram-status
system firmware reprogram-status state complete
system firmware reprogram-status detailed-message "Successfully reprogrammed host
firmware"
system firmware reprogram-status size 38043384
system firmware reprogram-status bytes-transferred 38043384
system firmware reprogram-status percent-complete 100
```

Upon completion the unit can be re-booted to the newly loaded image by navigating to the **Power** section.

## Configuring - Verify

To verify a firmware image, navigate to the **Verify Image** section and select the appropriate image (1 or 2) to verify. Once an image is selected, click on the **Begin Reprogramming** button to begin.

### Firmware ↻



**Figure 3-89. Verify Image**

The following example shows how to have the device verify image 1 from the CLI:

```
> request system firmware verify-image location 1
```

## Monitoring - Verifying

Once the verification is begun, the current status of the verification process is displayed on the web page. Note that the web page does not display the current status if the device has not been instructed to verify a firmware image (in other words, if the state is “inactive”).



## Firmware ↻

Status Actions

Reprogram Inactive Image

Verify Image

### Verify Image

Firmware Location \*  Begin Verification

### Verification Status

Current State	complete
Details	Successfully verified host firmware image
Percent Complete	<div style="width: 100%;"><div style="width: 100%;"></div></div> 100%

Copy Image

Power

**Figure 3-90. Verify Image Monitoring**

The verification status contains the following items:

- **Current State** – The status of the verification task:
  - inactive
  - processing
  - complete
  - failure
- **Detailed Message** – The details regarding the operation, such as “*Verifying host firmware image*”
- **Size** – The total number of bytes in the image (not displayed on the web UI)
- **Bytes Transferred** – The number of bytes already processed (not displayed on the web UI)
- **Percent Complete** – The percentage complete for the operation

To view the status of the verification process in the CLI, ensure the CLI is in operational mode and then follow the example below:

```
> show system firmware verify-image-status
system firmware verify-image-status state complete
system firmware verify-image-status detailed-message “Successfully verified host
firmware image”
system firmware verify-image-status size 38043384
system firmware verify-image-status bytes-transferred 38043384
system firmware verify-image-status percent-complete 100
```

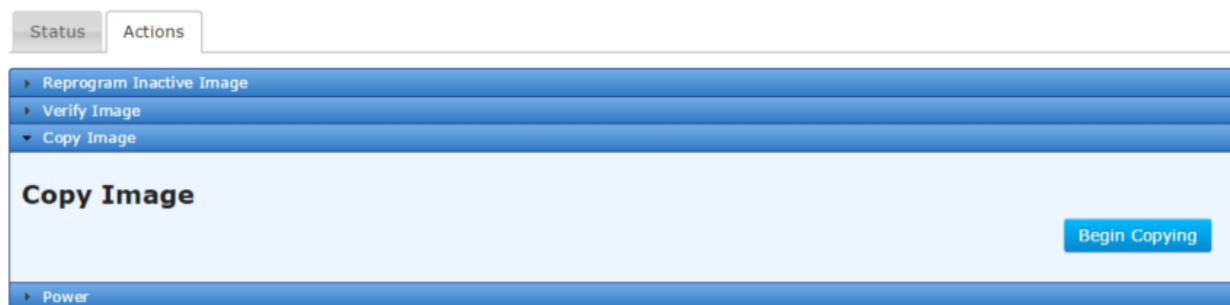
### Configuring - Copy

To copy the active firmware image to the inactive firmware image, navigate to the **Copy Image** section and click on the **Begin Copying** button to begin.





## Firmware ↻



**Figure 3-91. Copy Image**

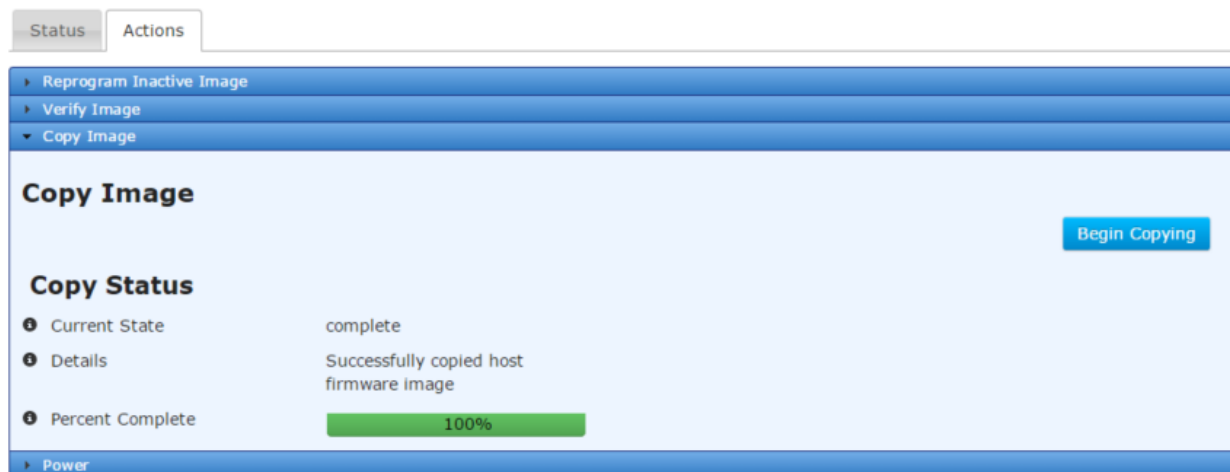
The following example shows how to have the device copy the active firmware image to the inactive firmware image from the CLI:

```
> request system firmware copy-image
```

### Monitoring - Copy

Once the copying is begun, the current status of the copying process is displayed on the web page. Note that the web page does not display the current status if the device has not been instructed to copy the firmware image (in other words, if the state is “inactive”).

## Firmware ↻



**Figure 3-92. Copy Image Monitoring**

The copy status contains the following items:

- **Current State** – The status of the copying task:
  - inactive
  - processing
  - complete
  - failure
- **Detailed Message** – The details regarding the operation, such as “*Copying host firmware image*”
- **Size** – The total number of bytes in the image (not displayed on the web UI)
- **Bytes Transferred** – The number of bytes already processed (not displayed on the web UI)



- **Percent Complete** – The percentage complete for the operation

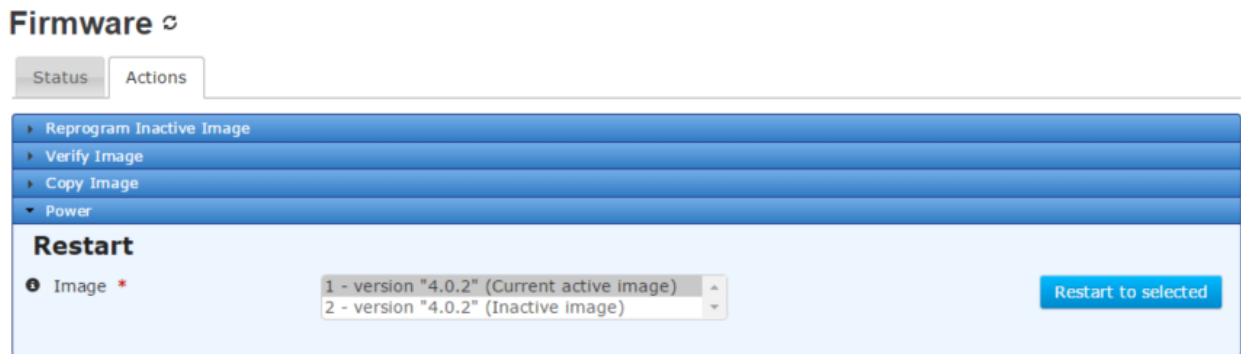
To view the status of the copy process in the CLI, ensure the CLI is in operational mode and then follow the example below:

```
> show system firmware copy-image-status
system firmware copy-image-status state complete
system firmware copy-image-status detailed-message "Successfully copied host firmware image"
system firmware copy-image-status size 38043384
system firmware copy-image-status bytes-transferred 38043384
system firmware copy-image-status percent-complete 100
```

## Configuring – Power

To restart the device to a specified firmware image, navigate to the **Power** section and select the appropriate image (1 or 2) to restart into. Once an image is selected, click on the **Restart to selected** button to begin.

Allow approximately 2 minutes for the unit to complete the restarting process and refresh the screen.



**Figure 3-93. Restart to Image**

To initiate a restart from the CLI, ensure the CLI is in operational mode and then follow the examples below to restart into the desired firmware image.

- > **request system power restart inactive**
- > **request system power restart active**
- > **request system power restart image 1**
- > **request system power restart version 4.0.2**

## File Servers

External file servers can be pre-configured in the CLI so that the configuration can easily be referenced in other services without the need to re-enter the information. File Server Configurations can be used for reprogramming, downloading certificates, configuration script import and export and sending support bundles for debugging.

The following shows how to add a file server configuration named “GE File Server 1”:

```
% set file-servers GE_file_server_1 tftp address 192.168.1.10
% commit

> show configuration file-servers
file-servers GE_file_server_1 {
    tftp {
        address 192.168.1.10;
    }
}
```



## 3.7.6 Tamper Detection

### Understanding

The magnetometer detects changes in magnetic field on X, Y and Z axis. The system will generate an alarm if any one of the axis readings exceeds user configurable threshold values. The readings are based on local magnetic fields and are used to detect changes to the readings in relation to the values when tamper protection is enabled.

### Operation

When enabled, the system calibrates the device. During calibration the axis readings are sampled to establish a baseline. When calibration is completed, the device enters operational mode. In operational mode, the axis readings, adjusted by the calibration results are used to determine current axis values. Readings which exceed the trigger thresholds on any axis, in either direction, will generate an alarm.

### Default Settings

#### Tamper Detection

Status	Basic Config	Advanced Config	Actions
▼ Magnetometer Calibration Offsets			
ⓘ X Axis		0	
ⓘ Y Axis		0	
ⓘ Z Axis		0	
▼ Magnetometer Current Offsets			
ⓘ X Axis		0	
ⓘ Y Axis		0	
ⓘ Z Axis		0	

- **Calibration Offsets** - Calibrated coordinates, determined when magnetometer tamper is enabled.
  - x-axis - The raw x coordinate value.
  - y-axis - The raw y coordinate value.
  - z-axis - The raw z coordinate value.
- **Current Offsets** - Current coordinates, offset from calibrated values.
  - x-axis - The raw x coordinate value.
  - y-axis - The raw y coordinate value.
  - z-axis - The raw z coordinate value.

This can be enabled from the Web UI. Navigate to *System / Tamper Detection* ---> *Basic Config*.

Tamper Detection			
Status	Basic Config	Advanced Config	Actions
▼ Magnetometer			
ⓘ Enabled		<input type="checkbox"/>	
▼ Magnetometer Trigger Thresholds			
ⓘ X Axis		<input type="text" value="50"/>	
ⓘ Y Axis		<input type="text" value="50"/>	
ⓘ Z Axis		<input type="text" value="50"/>	



- **Enabled** - Indicates whether magnetometer is enabled for use. Enabling magnetometer performs a calibration to zero the current coordinate values.
- **Trigger Thresholds** - used to configure the device's sensitivity. Merely rotating the unit or moving it along any axis (for example, 6 to 12 inches) may be enough to trigger an alarm with thresholds at the minimum values. Setting the thresholds at the maximum values will prevent alarms from occurring under normal circumstances. However, unusual circumstances, such as setting a strong magnet on the unit, may still trigger an alarm
  - x-axis - alarm trigger threshold for x-axis. Default = 50 range : 25 - 2000
  - y-axis - alarm trigger threshold for y-axis. Default = 50 range : 25 - 2000
  - z-axis - alarm trigger threshold for z-axis. Default = 50 range : 25 - 2000

**NOTE** None of these numbers for coordinates or thresholds has meaningful units. They are just values that are all relative to each other. A value of 50 cannot be equated to a specific number such as 6 inches.

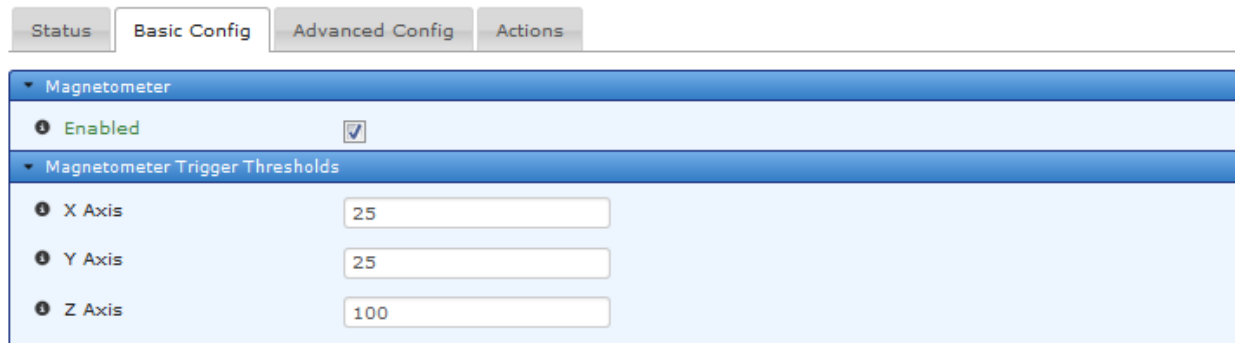
In the CLI to view this, enter configuration mode and execute the following command:

```
% show system tamper-detection magnetometer | details
enabled false;
trigger-thresholds {
  x-axis 50;
  y-axis 50;
  z-axis 50;
}
```

## Configuring

Set trigger thresholds and enable the device. This will start the calibration process. Use the Web UI as show above, change the values, enable the device and press **Save**.

### Tamper Detection



Tab	Value
Enabled	<input checked="" type="checkbox"/>
X Axis	25
Y Axis	25
Z Axis	100

On the CLI issue the following;

```
% set system tamper-detection magnetometer trigger-thresholds x-axis 25
% set system tamper-detection magnetometer trigger-thresholds y-axis 25
% set system tamper-detection magnetometer trigger-thresholds z-axis 100
% set system tamper-detection magnetometer enabled true
```

## Monitoring

Example of device status during calibration period:



## Tamper Detection ↻

Status	Basic Config	Advanced Config	Actions
▼ Magnetometer Calibration Offsets			
ⓘ X Axis		0	
ⓘ Y Axis		0	
ⓘ Z Axis		0	
▼ Magnetometer Current Offsets			
ⓘ X Axis		-917	
ⓘ Y Axis		844	
ⓘ Z Axis		1652	

From the CLI the Device status during calibration period *could* look like this:

```
> show system tamper-detection magnetometer
system tamper-detection magnetometer calibration-offsets x-axis 0
system tamper-detection magnetometer calibration-offsets y-axis 0
system tamper-detection magnetometer calibration-offsets z-axis 0
system tamper-detection magnetometer current-offsets x-axis -917
system tamper-detection magnetometer current-offsets y-axis 844
system tamper-detection magnetometer current-offsets z-axis 1652
```

Example of device status when operational (after calibration):

## Tamper Detection ↻

Status	Basic Config	Advanced Config	Actions
▼ Magnetometer Calibration Offsets			
ⓘ X Axis		-916	
ⓘ Y Axis		840	
ⓘ Z Axis		1648	
▼ Magnetometer Current Offsets			
ⓘ X Axis		-2	
ⓘ Y Axis		2	
ⓘ Z Axis		-2	

From the CLI the Device status when operational (after calibration) could be:

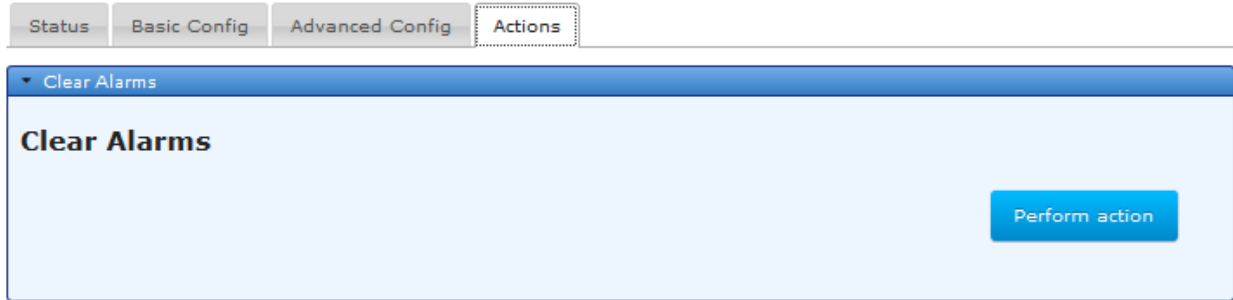
```
> show system tamper-detection magnetometer
system tamper-detection magnetometer calibration-offsets x-axis -916
system tamper-detection magnetometer calibration-offsets y-axis 840
system tamper-detection magnetometer calibration-offsets z-axis 1648
system tamper-detection magnetometer current-offsets x-axis -2
system tamper-detection magnetometer current-offsets y-axis -0
system tamper-detection magnetometer current-offsets z-axis -2
```

## Tamper Alarms

Once tamper detection is enabled the alarm will be triggered when the magnetometer readings exceed the configurable offsets. To clear the alarm, navigate to **System / Tamper Detection / ---> Actions / Clear Alarms** and press **Perform Action**. After confirmation, the following screen will show.



## Tamper Detection ↻



From the CLI the command can be issued as follows:

```
> request system tamper-detection clear-alarms
```

### 3.7.7 Configuration Files

#### Understanding

An exported configuration script will contain all of the settable parameters of the unit for which the current user has read-access. For example, configuration scripts exported by the tech user will not contain values which only the admin user has permissions to view. Configuration scripts can be saved and used to restore known-good configurations.

**NOTE** A configuration file cannot be used to update a single parameter. Importing a configuration file will update all parameters that the current user has permission to change. Any parameters missing from the configuration file on import will be assumed by the radio to be deleted. Make certain that all necessary parameters are kept in the configuration file unless they are expected to be deleted.

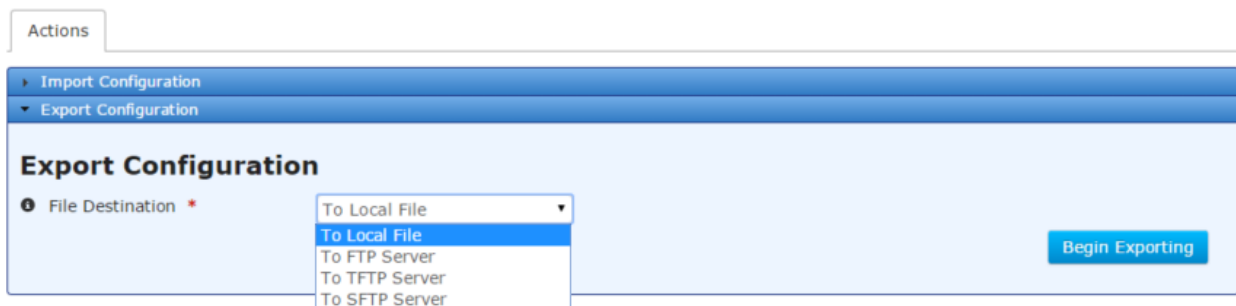
#### Configuring - Export

The following example shows how to have the device export the current configuration and download that configuration to a local file through the web browser.

Navigate to *System / Config Files* ---> *Actions / Export Configuration*

Click on the **Begin Exporting** button once the file destination is configured.

#### Config Files ↻



**Figure 3-94. Export Configuration**

The MCR supports file downloads through a web browser to a local file on the user's PC. The MCR also supports FTP, TFTP, and SFTP file uploads using external remote servers.

- **File Destination** - File transfer method to use. Available choices are To Local File (DEFAULT), To FTP Server, To TFTP Server, and To SFTP Server. Local file downloads are only available through the web UI and not through the CLI



- **Server Address** - For FTP, TFTP, and SFTP, the remote server's host name or IP address
- **File Path** - For FTP, TFTP, and SFTP, the path to the destination file on the remote server
- **User Name** - For FTP and SFTP, the user name on the remote server
- **Password** - For FTP and SFTP, the password on the remote server
- **Control Port** - For FTP, the TCP control port (advanced setting - use default)
- **Data Port** - For FTP, the TCP data port (advanced setting - use default)
- **Block Size** - For TFTP, the block size as defined in RFP 2348 (advanced setting - use default)
- **Timeout** - For FTP, TFTP, and SFTP, the timeout in seconds (advanced setting - use default)

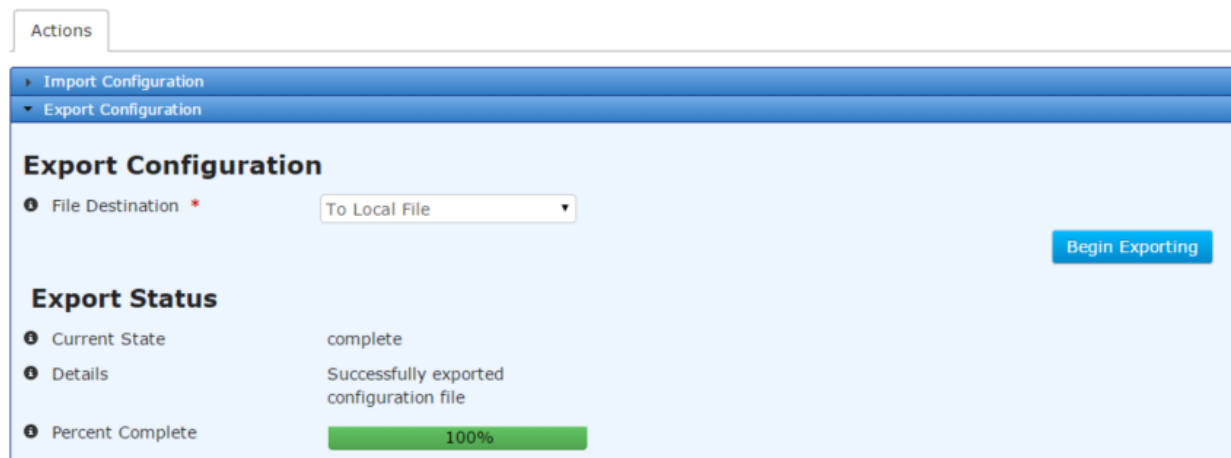
The following example shows how to have the device generate and export a configuration file (named config-2016-02-04.xml) to a TFTP server running on a host (address 192.168.1.10) that is accessible from the MCR (e.g. a locally connected host or remote host accessible via cellular interface). To start the configuration file export from the CLI, enter the following command to upload the configuration file to an external TFTP server:

```
> request system configuration-files export filename config-2016-02-04.xml manual-file-server { tftp { address 192.168.1.10 } }
```

## Monitoring - Export

Once the export of the configuration file is begun, the process may be cancelled by clicking the **Cancel Exporting** button. The current status of the configuration file export process is displayed on the web page. Note that the web page does not display the current status if the device has not been instructed to export a configuration file (in other words, if the state is “inactive”).

### Config Files



**Figure 3-95. Export Configuration Monitoring**

The export status contains the following items:

- **Current State** – The status of the export configuration file task:
  - inactive
  - preparing
  - transferring
  - cancelling
  - complete
  - failure



- cancelled
- **Detailed Message** – The details regarding the operation, such as “*Generating configuration file*”
- **Size** – The total number of bytes in the file (not displayed on the web UI)
- **Bytes Transferred** – The number of bytes already generated or transferred (not displayed on the web UI)
- **Percent Complete** – The percentage complete for the operation

To view the status of the process in the CLI, ensure the CLI is in operational mode and then follow the example below:

```
> show system configuration-files export-status
system configuration-files export-status state complete
system configuration-files export-status detailed-message “Successfully exported
configuration file”
system configuration-files export-status size 10396
system configuration-files export-status bytes-transferred 10396
system configuration-files export-status percent-complete 100
```

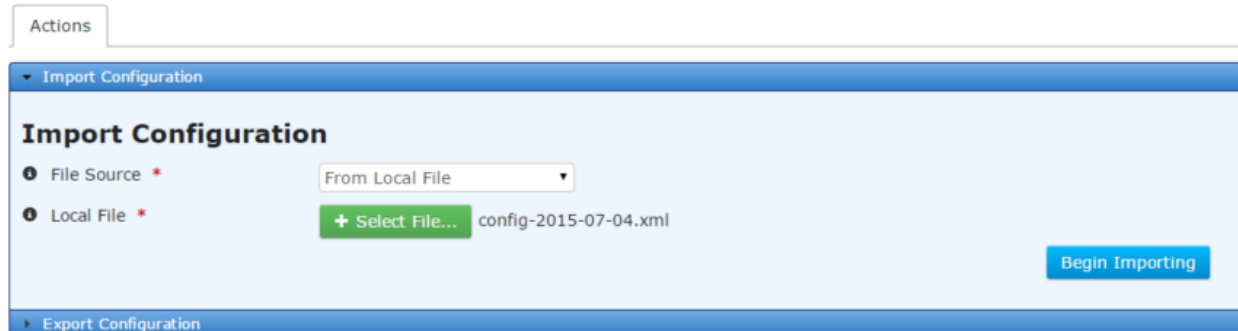
## Configuring - Import

The following example shows how to have the device import a set of configuration parameters by uploading a local file through the web browser.

Navigate to *System / Config Files ---> Actions / Import Configuration*

Click on the **Begin Importing** button once the file source is configured.

### Config Files



**Figure 3-96. Import Configuration**

The MCR supports file uploads through a web browser from a local file on the user’s PC. The MCR also supports HTTP, FTP, TFTP, and SFTP file downloads using external remote servers.

- **File Source** - File transfer method to use. Available choices are From Local File (DEFAULT), From HTTP Server, From FTP Server, From TFTP Server, and From SFTP Server. Local file uploads are only available through the web UI and not through the CLI
- **Local File** - For a local file, the file to upload as chosen by the file dialog popped up by the **Select File...** button
- **URL** - For HTTP, the location of the source file
- **Server Address** - For FTP, TFTP, and SFTP, the remote server's host name or IP address
- **File Path** - For FTP, TFTP, and SFTP, the path to the source file on the remote server
- **User Name** - For FTP and SFTP, the user name on the remote server
- **Password** - For FTP and SFTP, the password on the remote server





- **Control Port** - For FTP, the TCP control port (advanced setting - use default)
- **Data Port** - For FTP, the TCP data port (advanced setting - use default)
- **Block Size** - For TFTP, the block size as defined in RFP 2348 (advanced setting - use default)
- **Timeout** - For FTP, TFTP, and SFTP, the timeout in seconds (advanced setting - use default)

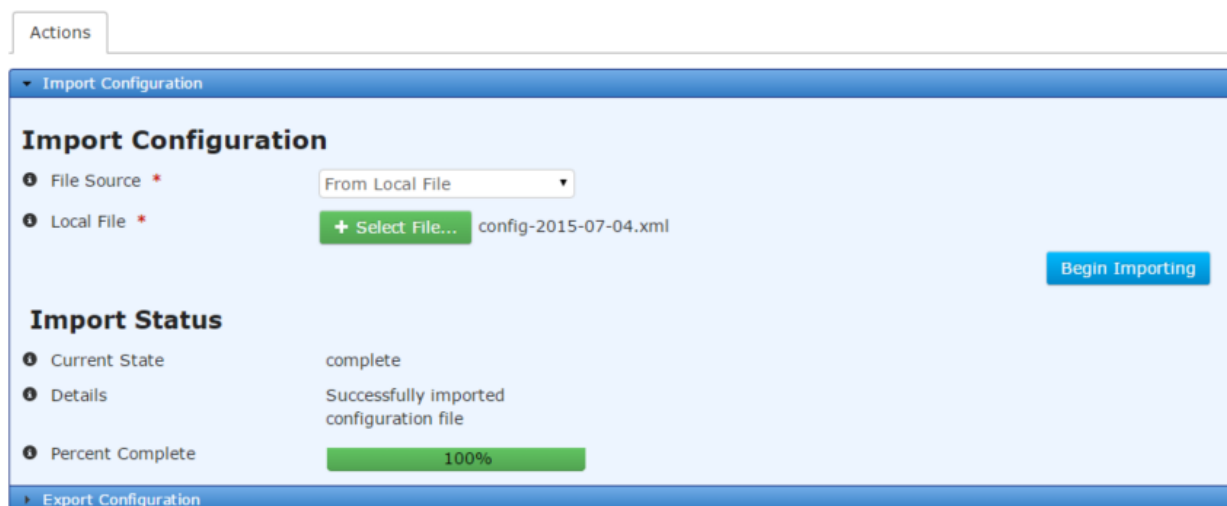
The following example shows how to have the device download a configuration file (named config-2016-02-04.xml) from a TFTP server running on a host (address 192.168.1.10) that is accessible from the MCR (e.g. a locally connected host or remote host accessible via cellular interface). To start the configuration file import from the CLI, enter the following command to download the configuration from the TFTP server:

```
> request system configuration-files import filename config-2016-02-04.xml manual-file-server { tftp { address 192.168.1.10 } }
```

## Monitoring - Import

Once the import of a configuration file is begun, the process may be cancelled by clicking the **Cancel Import** button. The current status of the import process is displayed on the web page. Note that the web page does not display the current status if the device has not been instructed to import a configuration file (in other words, if the state is “inactive”).

### Config Files



**Figure 3-97. Import Configuration Monitoring**

The import status contains the following items:

- **Current State** – The status of the import task:
  - inactive
  - transferring
  - processing
  - cancelling
  - complete
  - failure
  - cancelled
- **Detailed Message** – The details regarding the operation, such as “*Transferring configuration file*”
- **Size** – The total number of bytes in the file (not displayed on the web UI)



- **Bytes Transferred** – The number of bytes already transferred or processed (not displayed on the web UI)
- **Percent Complete** – The percentage complete for the operation

To view the status of the import process in the CLI, ensure the CLI is in operational mode and then follow the example below:

```
> show system configuration-files import-status
system configuration-files import-status state complete
system configuration-files import-status detailed-message "Successfully imported
configuration file"
system configuration-files import-status size 10396
system configuration-files import-status bytes-transferred 10396
system configuration-files import-status percent-complete 100
```

### 3.7.8 DNS

#### Understanding

Domain Name System (DNS) servers can be configured on the unit to facilitate the resolution of domain names to IP addresses.

---

**NOTE** Manual configuration of DNS overrides any DNS settings obtained via DHCP.

---

#### Configuring

##### Using the Web UI

The following example shows how to configure a DNS server with IP address 192.168.1.2 on the MCR.

Navigate to *System / DNS ---> Basic Config*

DNS

Status Basic Config Advanced Config Actions

General

Search

Server

Timeout

Attempts

Figure 3-98. DNS Menu

The following options are available.

- **Search** – Optional parameter. A list of domains or IP addresses to add to a non-fully qualified domain name when performing a DNS query. If entering more than one value, separate them with a space.
- **Server** – The intended DNS server’s IP address.
- **Timeout** – The amount of time in seconds that the unit will wait for a response from the DNS server before retrying.
- **Attempts** – The number of attempts the unit will query the DNS server before giving up.

##### Using the CLI

The following example shows how to configure a DNS server with IP address 192.168.1.2 on the MCR. Note that the “search” option can take a list of arguments and in this example, there are two arguments; mds and gemds.



```
% set system dns server 192.168.1.2 search [mds gemds] options attempts 3 timeout 3
```

## Monitoring

Ensure the CLI is in operational mode. Follow the example below to view the state and statistics.

The ping utility can be used on the CLI when it is in operational mode to verify that DNS is working properly. If ping can resolve a name on the connected network to an IP address then DNS settings are working properly. The example below shows the resolution of the name “example.com” to the IP address “192.0.43.10” on a unit that is connected to the Internet.

Use the control sequence “CTRL-C” to stop the ping utility.

```
> ping example.com
PING example.com (192.0.43.10) 56(84) bytes of data.
64 bytes from 43-10.any.icann.org (192.0.43.10): icmp_req=1 ttl=128 time=184 ms
64 bytes from 43-10.any.icann.org (192.0.43.10): icmp_req=2 ttl=128 time=132 ms
64 bytes from 43-10.any.icann.org (192.0.43.10): icmp_req=3 ttl=128 time=172 ms

--- example ping statistics ---
3 packets transmitted, 3 received, 0% packet loss, time 2002ms
rtt min/avg/max/mdev = 132.818/163.231/184.739/22.112 ms
```





## 3.8 Networking Services and Routing

### 3.8.1 Network

#### Understanding

The unit supports multiple networking features that are either implemented as virtual network interfaces (Bridge, VLAN, GRE, Bond) or as network services or applications operating on these virtual and other physical interfaces (LAN, Cell, WiFi, 900Mhz). Following provides a brief overview of these networking features:

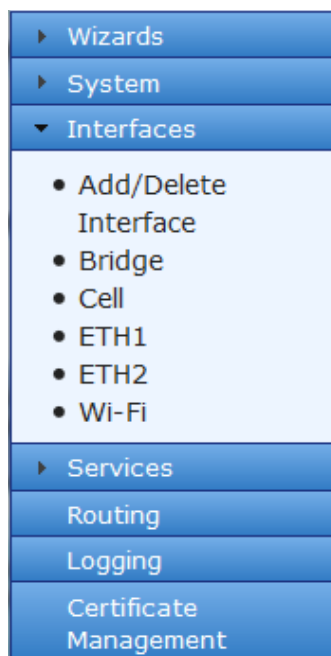
- **Dynamic IP addressing**
  - **DHCP Client** - The unit supports DHCP client operation on various physical and virtual interfaces.
  - **DHCP Server** - The unit supports DHCP server operation to assign dynamic IP addresses to other devices connected to it over various network interfaces.
- **Bridging** - The unit supports bridging feature by creation of network interfaces of type 'bridge' that can contain one or more network interfaces as members of this interface. The unit also supports spanning tree protocol (STP) to prevent formation of loops in the bridged network.
- **VLAN** - The unit supports VLAN feature by creation of network interface of type 'vlan' and configuration of the other network interfaces in the system as members of this VLAN interface.
- **Firewall** - The unit supports firewall feature to accept/drop incoming or outgoing traffic by configuration of Access Control List (ACL) filters on the network interfaces.
- **Network Address Translation (NAT)** - The unit supports following types of Network Address Translation (NAT):
  - **Destination NAT (Port Forwarding)** - Translating the destination address (and/or port) of traffic ingressing the unit. Destination NAT allows forwarding of traffic directed to a public (external network) IP address (and/or port) to a private (internal network) IP address (and/or port).
  - **Source NAT (Masquerading)** - Source NAT allows private (internal network) hosts to share the same public (external network) IP addresses to enabling them to communicate with a host on the public/external network.
  - **Static NAT (One to One NAT)** - Translating a public (external network) address of traffic ingressing to a private (internal network) address and egressing the unit vice versa. Static NAT allows private (internal network) hosts to be accessible through a corresponding public (external network) address. This feature can be used to help connect networks with overlapping network address ranges.
- **Routing** - The unit supports static routing by allowing configuration of one or more static routes to various destination networks.
- **Virtual Private Network (VPN)** - The unit supports VPN feature by use of following types of tunnels:
- **IPsec Tunnel** - IPsec enables secure tunneling of unicast IP traffic from one private network to another over an untrusted (e.g. public) network.
- **GRE Tunnel** - Generic Routing Encapsulation (GRE) enables tunneling of unicast and multicast IP traffic (layer-3) or Ethernet (layer-2) traffic from one private network to another over another network. GRE tunnels do not provide any security. GRE and IPsec can be combined to enable following uses cases:
  - Sending multicast IP traffic securely from one private network to another over an untrusted network



- Sending Ethernet traffic securely from one private network to another over an untrusted network.
- **Network Link Failover/Failback** - The unit supports following two types of network link failover and failback features:
  - **Route (Layer-3) Failover** - The unit supports this feature by enabling configuration of multiple routes to same destination network with different preference (metric) values, enabling traffic to be sent using the route with high preference in normal scenario and failing back to the route with lower preference when the destination network is not reachable through the higher preference route.
  - **Link (Layer-2) Failover** - The unit supports this feature by creation of a bond interface in an active-backup mode that can aggregate a primary and secondary layer-2 link. When primary link is down, the secondary link is used to send layer-2 traffic etc.

From the Interface navigation bar, the status may be displayed by clicking on the interface within the list:

Navigate to: **Interfaces**



**Figure 3-99. Interface Menu Bar**

Each interface collects the same basic set of status information. The following example illustrates the information of the “Bridge”. Definitions that are provided may apply to any of the interfaces.

### Bridge Interface

Navigation tabs: Status | Basic Config | Advanced Config | Actions

General

Type*	bridge	Refresh every <input type="text"/> seconds
Admin Status*	up	
Oper Status*	up	
If Index*	1	
Phys Address	00:06:3d:07:96:82	

- **Type** - Indicates the Interface type - Read only system information
- **Admin Status** - The desired state of the interface - *Up* meaning operational



- **Oper Status** - The current status of the interface - *Up* meaning operational / *Down* meaning non-operational or disabled
- **Last Change** - The time the interface entered its current operational state. Blank if operational from startup.
- **If Index** - Interface Index. Used for debugging information only
- **Phys Address** - Generally for an 802.x interface this will be the mac address assigned to the interface. For interfaces that do not have such an address (e.g., a serial line), this node is not present.
- **Higher Layer If** - A list of references to interfaces layered on top of this interface. Used for debugging information only
- **Lower Layer If** - A list of references to interfaces layered underneath this interface. Used for debugging information only
- **Speed** - An estimate of the interface's current bandwidth in bits per second. For interfaces that do not vary in bandwidth or for those where no accurate estimation can be made, this info should contain the nominal bandwidth. For interfaces that have no concept of bandwidth, this info is not present.

Open up the *Statistics* drop-down below the *General* drop-down to view the statistics for the Bridge interface:

Counter	Value
Discontinuity Time*	Wed, 26 Nov 2014 16:05:18 GMT
In Octets	1076909
In Unicast Pkts	5735
In Broadcast Pkts	
In Multicast Pkts	0
In Discards	0
In Errors	0
In Unknown Protos	
Out Octets	6791513
Out Unicast Pkts	6278
Out Broadcast Pkts	
Out Multicast Pkts	
Out Discards	0
Out Errors	0

**Figure 3-100. Interface Statistics Screen**

- **Discontinuity Time** - The time on the most recent occasion at which any one or more of this interface's counters suffered a discontinuity or interruption of service.
- **In Octets** - The total number of octets received on the interface, including framing characters.
- **In Unicast Pkts** - The number of packets, delivered by this sub-layer to a higher (sub-)layer, which were not addressed to a multicast or broadcast address at this sub-layer.
- **In Broadcast Pkts** - The number of packets, delivered by this sub-layer to a higher (sub-)layer, which were addressed to a broadcast address at this sub-layer.
- **In Multicast Pkts** - The number of packets, delivered by this sub-layer to a higher (sub-)layer, which were addressed to a multicast address at this sub-layer.



- **In Discards** - The number of inbound packets discarded even though no errors had been detected to prevent their delivery to a higher-layer protocol. One possible reason for discarding such a packet could be to free up buffer space.
- **In Errors** - For packet-oriented interfaces, the number of inbound packets that contained errors preventing them from being deliverable to a higher-layer protocol.
- **In Unknown Protos** - For packet-oriented interfaces, the number of packets received via the interface which were discarded because of an unknown or unsupported protocol.
- **Out Octets** - The total number of octets transmitted out of the interface, including framing characters.
- **Out Unicast Pkts** - The total number of packets that higher-level protocols requested be transmitted, and which were not addressed to a multicast or broadcast address at this sub-layer, including those that were discarded or not sent.
- **Out Broadcast Pkts** - The total number of packets that higher-level protocols requested be transmitted, and which were addressed to a broadcast address at this sub-layer, including those that were discarded or not sent.
- **Out Multicast Pkts** - The total number of packets that higher-level protocols requested be transmitted, and which were addressed to a multicast address at this sub-layer, including those that were discarded or not sent.
- **Out Discards** - The number of outbound packets discarded even though no errors had been detected to prevent their transmission.
- **Out Errors** - For packet-oriented interfaces, the number of outbound packets that could not be transmitted because of errors.

Scroll down and click on to view information on IPv4 and IPv6 (not currently supported) information:

The screenshot shows the IPv4 configuration screen. At the top, it displays 'IPv4' and 'Mtu 1500'. Below this is the 'Address' section with a search bar and a table containing one entry: IP 10.10.10.141 with Origin static. Below that is the 'Neighbor' section with a search bar and a table containing one entry: IP 10.10.10.98, Link Layer Address 6c:c2:17:5e:d2:12, Origin dynamic, and State reachable. Both tables show 'Showing 1 to 1 of 1'.

IP	Origin
10.10.10.141	static

IP	Link Layer Address	Origin	State
10.10.10.98	6c:c2:17:5e:d2:12	dynamic	reachable

Figure 3-101. IPv4 Information Screen

### IPv4 - Specific information:

- **Address** - The list of IPv4 addresses on the interface
- **Neighbor**- A list of mappings from IPv4 addresses to link-layer addresses. This list represents the ARP cache.

From the CLI in operational mode, the command below may be issued to view the state and statistics of all the network interfaces. The result of this command is very verbose and includes status and statistics for all the defined interfaces. For the sake of brevity, only the bridge interface status information is shown below (similar information will be shown for each defined interface):





```

> show interfaces-state
  interfaces-state interface Bridge
  type      bridge
  admin-status up
  oper-status up
  if-index   1
  phys-address 00:06:3d:07:96:82
  statistics discontinuity-time 2014-02-12T14:29:35-05:00
  statistics in-octets 259644036
  statistics in-unicast-pkts 3188877
  statistics in-multicast-pkts 0
  statistics in-discards 4126
  statistics in-errors 0
  statistics out-octets 737353
  statistics out-unicast-pkts 1135
  statistics out-discards 0
  statistics out-errors 0
  ipv4 forwarding true
  ipv4 mtu 1500
  PREFIX
  IP          LENGTH ORIGIN
  -----
  10.10.10.141 23      static

  LINK LAYER
  IP          ADDRESS      ORIGIN STATE
  -----
  10.10.10.109 00:11:11:e0:2e:70 dynamic stale
  10.10.10.98  80:c1:6e:f0:3b:7a dynamic reachable

```

### 3.8.2 LAN

#### Understanding

The unit has external Local Area Network (LAN) ports (ETH1/2 ports) that can be used to connect to a local (wired) LAN. It supports both IPv4 and IPv6 addresses and may be assigned multiple IP addresses. The LAN port can be assigned static IP addresses or a dynamically allocated address can be assigned using DHCP.

---

**NOTE** The LAN port should be assigned IP addresses only if it is a routed interface (that is, *not* in a bridge).

---

#### Configuring

From the Interfaces screen the status may be displayed by clicking on the interface and scrolling down to the statistics information:

Navigate to: *Interfaces / Add/Delete Interfaces*



## Interfaces Management ↻

Configuration				
Search <input type="text"/>		Add ... Delete		<input type="button" value="Signal"/> <input type="button" value="Refresh"/> <input type="button" value="Search"/> <input type="button" value="Edit"/>
Name	Type	Enabled	Vlan	IPv4
Bridge	bridge	true	none -	10.10.10.141/23
Cell	cellular	true	none -	
ETH1	ethernet	true	none -	
ETH2	ethernet	true	none -	
Wi-Fi	wifi	true	none -	192.110.11.1/24

Showing 1 to 5 of 5

**Figure 3-102. Default Interfaces Configuration Screen**

To configure the LAN interface, select the ETH1 or ETH2 (if available - some units only support ETH1). As shown in the screens below, there are five groups of configuration settings that can be configured: General ETHx specifics, IPV4, QOS, Filter, and NAT

*Interfaces / Add/Delete Interfaces / ETHx ---> Basic Config*

### ETH1 Interface ↻

Status
Basic Config
Advanced Config
Actions

**General**

**Description**

**Enabled**

**Eth Phy Rate**

- Eth 10Mb Half
- Eth 10Mb Full
- Eth 100Mb Half
- Eth 100Mb Full

**Vlan Mode** None

**Figure 3-103. ETH1 Configuration Screen**

- **Description** - User defined identifier for this connection - 0-34 characters
- **Type** - Identifier of the type of interface - Do Not Change
- **Enabled** - Checked indicates Enabled (DEFAULT). Disable will prevent usage.
- **Eth Phy Rate** - Choose the Ethernet speed support setting (DEFAULT ALL)
  - Eth 10Mb Half
  - Eth 10Mb Full
  - Eth 100Mb Half
  - Eth 100Mb Full
- **Vlan Mode** - Virtual LAN Setting. (Ethernet port Security / Port-based Authentication)

### Understanding

Orbit devices support Ethernet-port security using port-based authentication. Port-based authentication blocks traffic on the front Ethernet port(s) until a RADIUS server determines that the device connected to the port is allowed to communicate on the network. The Orbit must have a route to the RADIUS server using another network channel in order for authentication to work. Port-based authentication can be enabled in either EAP (Extensible Authentication Protocol) mode or MAB (MAC Authentication Bypass) mode. Both modes require the use of RADIUS server.



In EAP security-mode, the Orbit will block all traffic on the Ethernet port but will still capture EAP frames. These EAP frames are then forwarded via RADIUS protocol to the configured RADIUS server. The Orbit is agnostic to the EAP method used between the Peer and RADIUS, so any EAP method can be used at the peer and RADIUS server (e.g. EAP-TLS). If the RADIUS server can successfully authenticate the peer connected to the Ethernet port, then it will send a RADIUS-ACCEPT message to the Orbit. When that message is received the Orbit stops blocking traffic on the Ethernet port.

In MAB security-mode, the Orbit will block all traffic on the Ethernet port but it still captures Ethernet frame headers so that it can read the source MAC address of ingress traffic. The Orbit sends RADIUS PAP (Password Authentication Protocol) requests for each MAC address that it captures until it receives a RADIUS-ACCEPT message from the RADIUS server. When the RADIUS-ACCEPT message is received the Orbit stops blocking traffic on the Ethernet port. The PAP requests are created with the following attributes:

Username: the MAC address, without punctuation, of the peer device connected to Ethernet port.

Example: *00063d089883*

Password: an encrypted version of the Username

Calling-Station-Id: the same as the Username but with hyphens.

Example: *00-06-3d-08-98-83*

In both security-modes, the NAS-IP address in the RADIUS request can be static or dynamic. A static NAS-IP is used when the Orbit's RADIUS configuration contains the NAS settings. If the static NAS settings are not set, the Orbit uses one its IP addresses that is able to route to the RADIUS server's address.

## Configuring

Configuration of port authentication first requires a RADIUS server configuration to be added to the Orbit. For example:

```
% set system mds-radius servers MyServer address 192.168.10.100 shared-secret  
    RadiusSharedSecret  
% commit
```

Port authentication can now be enabled on an Ethernet port. For example:

```
% set interfaces interface ETH1 security security-mode EAP radius-server  
    MyServer  
% commit
```

Ethernet security settings are not set by default so Ethernet traffic is unobstructed until security is enabled. Ethernet security settings include:

security-mode – either EAP, MAB, or none

radius-server – The name of a RADIUS server configuration in system settings

## Monitoring

Read-only parameters for Ethernet ports show the state of the security on the port:

```
run show interfaces-state interface ETH1 security
```



The security status will be displayed as one of the following states:

- security disabled – Security is disabled for this port and traffic is not blocked
- security authorized – The port has been authorized by a RADIUS server and traffic is not blocked
- security rejected – The RADIUS server rejected the last authentication request
- security pending – A RADIUS request was sent and the Orbit is waiting for a response

- VLAN Operation): Valid Choices
  - None (DEFAULT)
  - Access - Use this if this interface is intended to be a member of only a single VLAN.
  - Trunk - Use this if this interface is intended to be a member of multiple VLANs.

IPv4

IPv4

Enabled

Forwarding

Mtu

**Address**

Search  Add ... Delete

IP

Table is empty

**Neighbor**

Search  Add ... Delete

IP  Link Layer Address

Table is empty

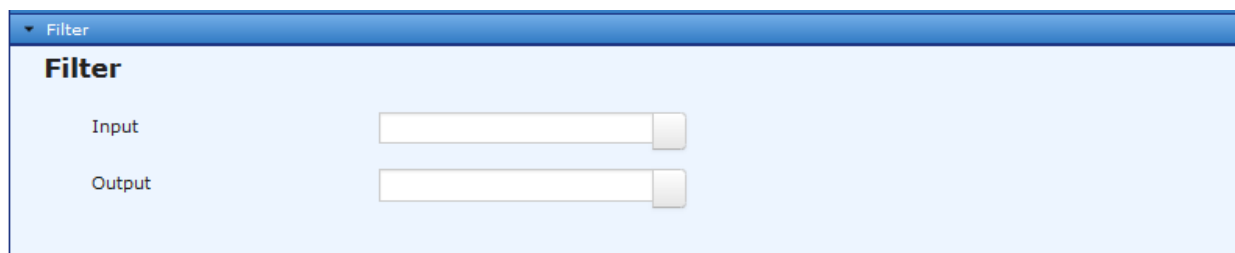
Dhcp

- **Enabled** - Enable or disable the use of an IP address
- **Forwarding** - Indicates if IPv4 packet forwarding is enabled or disabled on this interface. **True** (DEFAULT) / **False**
- **Mtu** - The size, in octets, of the largest IPv4 packet that the interface will send and receive. Range 68-65535 - 1500 (DEFAULT). (Advanced setting)
- **Address** - Use for creating static IPv4 IP address and removing this interface from the built-in Network Bridge.
- **Neighbor**- Use for creating mappings from IPv4 addresses to link-layer addresses.

QoS

Output

- **Output** - Use for selecting and applying a QoS policy (from the available QoS policies) to the outgoing traffic on this interface. See "Quality of Service (QoS)" on Page 203, for more information on creating QoS policies.



**Figure 3-104. Filter Setup Screen**

- **Filter Input** - Use for selecting and applying a firewall filter (from available filters) to incoming traffic on this interface.
- **Filter Output** - Use for selecting and applying a firewall filter (from available filters) to outgoing traffic on this interface.

For more information on packet filtering, refer to Access Control List (Packet Filtering / Firewall)

- **Input** - Default Selections (others may have been added) :
  - IN\_TRUSTED
  - IN\_UNTRUSTED
  - OUT\_TRUSTED
  - OUT\_UNTRUSTED
- **Output** - Default Selections (others may have been added) :
  - IN\_TRUSTED
  - IN\_UNTRUSTED
  - OUT\_TRUSTED
  - OUT\_UNTRUSTED



**Figure 3-105. Network Address Translation (NAT) Setup**

- **Source** - Source NAT performs translation of source IP address of the traffic going out of the interface. Source NAT (Masquerading). Use for selecting and applying a source NAT rule-set (from available source nat rule-sets) to outgoing traffic on this interface. Choices:
  - **MASQ - MASQuerading** - This rule-set translates the source address of the outgoing traffic to use the interface's IP address. In general, IP masquerading allows the user to use a private (reserved) IP network addresses on the LAN and still allow these devices to communicate with devices on the other side of the masqueraded interface that are not aware of the internal private addresses.
- **Destination**- Destination NAT performs translation of destination IP address (and, optionally, destination port) of the traffic coming into the interface. Destination NAT (Port Forwarding). Use for selecting and applying a destination NAT rule-set (from available destination nat rule-sets) to incoming traffic on this interface



- **Static** - Static NAT performs translation of a network address to another network address for incoming and outgoing traffic. Refer to 3.8.10-Static NAT (One to One NAT) page 160. Use for selecting and applying a static NAT rule-set (from available static nat rule-sets) to incoming and outgoing traffic on this interface.

Using the CLI, the following sequence shows how to configure the ETH1 port to obtain a dynamic IPv4 address using DHCP:

```
> configure
  Entering configuration mode private
% set interfaces interface ETH1 ipv4 dhcp
% commit
```

Before configuring a new IP address, be sure to remove the previous address by issuing the command

```
% delete interfaces interface ETH1 ipv4
```

The following sequence shows how to configure the ETH1 port with a static IPv4 address:

```
> configure
  Entering configuration mode private
% set interfaces interface ETH1 ipv4 address 192.168.1.11 prefix-length 24
% commit
```

## Monitoring

Ensure the CLI is in Operational mode. Follow the example below to view the state and statistics of the ETH1 port:

```
> show interfaces-state interface ETH1
  interfaces-state interface ETH1
  type          ethernet
  admin-status  up
  oper-status   up
  if-index      3
  phys-address  00:06:3d:07:96:82
  statistics discontinuity-time 2014-02-12T14:29:35-05:00
  statistics in-octets 497076597
  statistics in-unicast-pkts 6457046
  statistics in-multicast-pkts 0
  statistics in-discards 17
  statistics in-errors 0
  statistics out-octets 1002105
  statistics out-unicast-pkts 6480
  statistics out-discards 0
  statistics out-errors 0
  eth-phy-status "10 Mb, Half Duplex"
  ipv4 forwarding true
  ipv4 mtu 1500
```

IP	PREFIX LENGTH	ORIGIN
10.10.10.147	23	static

IP	LINK LAYER ADDRESS	ORIGIN	STATE
----	--------------------	--------	-------



-----  
10.10.10.98 80:c1:6e:f0:3b:7a dynamic reachable

### 3.8.3 Ethernet port Security / Port-based Authentication

#### Understanding

Orbit devices support Ethernet-port security using port-based authentication. Port-based authentication blocks traffic on the front Ethernet port(s) until a RADIUS server determines that the device connected to the port is allowed to communicate on the network. The Orbit must have a route to the RADIUS server using another network channel in order for authentication to work. Port-based authentication can be enabled in either EAP (Extensible Authentication Protocol) mode or MAB (MAC Authentication Bypass) mode. Both modes require the use of RADIUS server.

In EAP security-mode, the Orbit will block all traffic on the Ethernet port but will still capture EAP frames. These EAP frames are then forwarded via RADIUS protocol to the configured RADIUS server. The Orbit is agnostic to the EAP method used between the Peer and RADIUS, so any EAP method can be used at the peer and RADIUS server (e.g. EAP-TLS). If the RADIUS server can successfully authenticate the peer connected to the Ethernet port, then it will send a RADIUS-ACCEPT message to the Orbit. When that message is received the Orbit stops blocking traffic on the Ethernet port.

In MAB security-mode, the Orbit will block all traffic on the Ethernet port but it still captures Ethernet frame headers so that it can read the source MAC address of ingress traffic. The Orbit sends RADIUS PAP (Password Authentication Protocol) requests for each MAC address that it captures until it receives a RADIUS-ACCEPT message from the RADIUS server. When the RADIUS-ACCEPT message is received the Orbit stops blocking traffic on the Ethernet port. The PAP requests are created with the following attributes:

Username: the MAC address, without punctuation, of the peer device connected to Ethernet port.

Example: *00063d089883*

Password: an encrypted version of the Username

Calling-Station-Id: the same as the Username but with hyphens.

Example: *00-06-3d-08-98-83*

In both security-modes, the NAS-IP address in the RADIUS request can be static or dynamic. A static NAS-IP is used when the Orbit's RADIUS configuration contains the NAS settings. If the static NAS settings are not set, the Orbit uses one its IP addresses that is able to route to the RADIUS server's address.

#### Configuring

Configuration of port authentication first requires a RADIUS server configuration to be added to the Orbit. For example:

```
% set system mds-radius servers MyServer address 192.168.10.100 shared-secret  
    RadiusSharedSecret  
% commit
```

Port authentication can now be enabled on an Ethernet port. For example:

```
% set interfaces interface ETH1 security security-mode EAP radius-server  
    MyServer  
% commit
```



Ethernet security settings are not set by default so Ethernet traffic is unobstructed until security is enabled. Ethernet security settings include:

- security-mode – either EAP, MAB, or none
- radius-server – The name of a RADIUS server configuration in system settings

## Monitoring

Read-only parameters for Ethernet ports show the state of the security on the port:

```
run show interfaces-state interface ETH1 security
```

The security status will be displayed as one of the following states:

- security disabled – Security is disabled for this port and traffic is not blocked
- security authorized – The port has been authorized by a RADIUS server and traffic is not blocked
- security rejected – The RADIUS server rejected the last authentication request
- security pending – A RADIUS request was sent and the Orbit is waiting for a response

## 3.8.4 VLAN Operation

### Understanding

A Virtual Local Area Network (VLAN) is a logically segmented LAN network that exists across multiple physical LAN devices. The VLANs are virtual interface types in the Orbit MCR and can be assigned unique IP addresses. They are treated the same as any other interface type, but they offer a way to link traffic between member interfaces. As such, a VLAN device can be thought of as a bridging device

### Configure

To utilize VLANs, at least one or more VLAN interfaces must be created. Click on **+Add** on the *Interfaces / Add/Delete Interface Screen*. Below are the minimal steps to set up a VLAN virtual device:

#### Interfaces Management

Name	Type	Enabled	Vlan	IPv4
Bridge	bridge	true	none	10.10.10.141/23
Cell	cellular	true	none	
ETH1	ethernet	true	none -	
ETH2	ethernet	true	none -	
Wi-Fi	wifi	true	none	192.110.11.1/24

Showing 1 to 5 of 5

Create the VLAN as an interface with a name by clicking on the **Add** button.





Please select the Interface Type

Type\* Vlan

Name: mgnt\_vlan

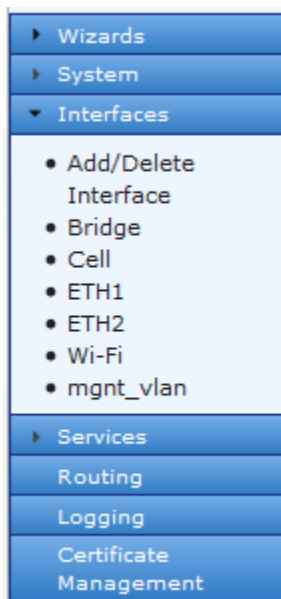
OK Cancel

**Figure 3-106. VLAN Creation**

- **Type** – Interface type to be created. In this case, choose Vlan.
- **Name** - The name of the interface. Up to 48 characters.

### Configure the newly created VLAN

After clicking the OK button on the pop-up in Creation will automatically take the configuration screen for that interface, or click on the new interface located in the **Interfaces** navigation section.



### mgnt\_vlan Interface

Status Basic Config Advanced Config Actions

General

Description

Enabled

- **Description** - User defined identifier for the this connection up to 34 characters
- **Enabled** - Checked indicates enabled (DEFAULT). Disable will prevent usage.

Scroll down and set the VLAN ID



Vlan

Vlan Config

Vlan ID

Native Vlan

- **Vlan ID** - The ID of this VLAN Valid values: 1—4094
- **Native Vlan** - If true, this is the native VLAN of this device. Native VLAN packets will not egress as tagged packets.

The example that follows illustrates the result of setting up 2 VLANs; one with an ID of 99 and another with an ID of 300:

## Interfaces Management [↗](#)

Configuration

Search  Add ... Delete 📶 ↻ 🔍 ✎

Name	Type	Enabled	Vlan	IPv4
Bridge	bridge	true	none -	10.10.10.141/23
Cell	cellular	true	none -	
ETH1	ethernet	true	none -	
ETH2	ethernet	true	none -	
Wi-Fi	wifi	true	none -	192.110.11.1/24
mgmt_vlan	vlan	true	99	
video_vlan	vlan	true	300	

Showing 1 to 7 of 7

**Figure 3-107. VLAN Interfaces Created**

Using the CLI to set up a VLAN, four sample commands are shown below for doing this; one with an ID of 99 and another with an ID of 300:

```
% set interfaces interface mgmt_vlan type vlan
% set interfaces interface mgmt_vlan vlan-config vlan-id 99
% set interfaces interface video_vlan type vlan
% set interfaces interface video_vlan vlan-config vlan-id 300
```

## Operational Modes

As previously shown in previous sections, interfaces can have three separate VLAN modes: none (default), trunk, or access. These modes are used to set interface behavior, and examples of their use are provided below.

**Trunk:** To add ETH1 as a trunk (tagged) port in both defined VLANs above, the command is:

```
% set interfaces interface ETH1 vlan-mode trunk vlans [video_vlan mgmt_vlan]
```

**Access:** To set ETH2 as an access port for video\_vlan the command is:

```
% set interfaces interface ETH2 vlan-mode access vlan video_vlan
```

## Native VLANs

A VLAN device may also be specified as a “native” VLAN by checking the **Native Vlan** box.



## mgnt\_vlan Interface

Status Basic Config **Advanced Config** Actions

General

Vlan

Vlan Config

Vlan ID

Native Vlan

Figure 3-108. VLAN Configuration - VLAN Id

Or, using the CLI with this set command:

```
% set interfaces interface my_native_vlan type vlan vlan-config vlan-id 99 native-vlan true
```

A native VLAN is conceptually the same as a standard VLAN except that the packets will never be tagged. The purpose of a native VLAN is to segregate untagged packets on a VLAN trunk port that normally only contains tagged traffic. If a VLAN trunk port receives an untagged packet, and the trunk is a member of the native VLAN, that packet will be treated as if it came from the native VLAN. If the trunk port is not a member of the native VLAN and an untagged packet arrives on that port, the packet will be dropped.

As VLANs are implemented as bridges, and it is not valid for a bridge to be a member of another bridge, it follows that a VLAN interface cannot be configured as a member of a bridge. VLANs can be configured with IP addresses just as any other interface in the system.

## Monitoring

As shown previously once VLANs are created they may be monitored on the Interface status screen the same way physical interfaces appear:

## Interfaces Management

Configuration

Search  Add ... Delete

Name	Type	Enabled	Vlan	IPv4
Bridge	bridge	true	none -	10.10.10.141/23
Cell	cellular	true	none -	
ETH1	ethernet	true	none -	
ETH2	ethernet	true	none -	
Wi-Fi	wifi	true	none -	192.110.11.1/24
mgnt_vlan	vlan	true	99	
video_vlan	vlan	true	300	

Showing 1 to 7 of 7

Figure 3-109. Interface Status Screen

## 3.8.5 Bridging

### Understanding

The unit supports transparent bridging of LAN, WiFi/900Mhz networks. The bridge forwards traffic between LAN and WiFi/900Mhz networks at the layer-2 of OSI model. This allows LAN and WiFi/900Mhz clients to be in the same IP sub-network.



The bridge learns the clients' locations by analyzing the source address of incoming frames from all attached networks (LAN and WiFi network). For example, if a bridge sees a frame arrive on LAN port from Host A, the bridge concludes that Host A can be reached through the segment connected to LAN port. Through this process, the bridge builds a forwarding table (the learning process). When a frame is received on one of the bridge's interfaces, the bridge looks up the frame's destination address in its forwarding table. If the table contains an association between the destination address and any of the bridge's ports aside from the one on which the frame was received, the frame is forwarded out the indicated port. If no association is found, the frame is flooded to all ports except the inbound port. Broadcasts and multicast also are flooded in this way.

Typically, for LAN/WiFi-to-Cellular Router use case (a.k.a. LAN/WiFi HotSpot), the LAN and WiFi interface (acting as an Access Point) are bridged. However, for security and bandwidth considerations, a user might want to remove LAN and WiFi networks from the bridge (*i.e.*, configuring LAN and WiFi networks as separate IP networks). In this network setup, broadcast/multicasts data packets coming into WiFi are not directed out the LAN connection and vice versa.

The bridged network is addressable via bridge interface (a virtual interface). The interfaces that are in the bridge are called bridged interfaces. The interfaces that are not in the bridge are called routed interfaces. Bridging is performed between bridged interfaces. Routing is performed between routed interfaces. The bridge interface itself is a routed interface.

---

**NOTE** The Cellular interface cannot be added to the bridge and is, therefore, a routed interface. However, a GRE interface in 'ethernet-over-gre' mode can be configured to operate over Cell interface and added to a bridge to enable tunneling of layer-2 traffic over the cellular network. Refer to section on GRE for more details. Advanced details of networking concepts such as routing and bridging are outside the scope of this manual but are available through various training materials freely available on the Internet.

---

## Theory of Operation

Refer to Figure 3-110 below for this discussion. In a typical application, the MCR-4G provides cellular connectivity to locally connected devices that are located on the user's local/internal/private LAN or WiFi network. The MCR-4G acts as an Access Point on the Wi-Fi interface, providing connectivity to Wi-Fi clients. The Wi-Fi traffic is combined with the local Ethernet port traffic through a Layer 2 bridge. The serial interface is matched to a terminal server that encapsulates serial data over a TCP or UDP connection.

The MCR-4G provides Network Address Translation (NAT) (both Masquerading and Port Forwarding) as well as Firewalling between the cellular data interface (WAN side) and the local network (LAN/WiFi). The MCR-4G can also act as a VPN client to provide a secure tunnel for LAN data to the user's local network (LAN/WiFi). This configuration obviates the need for NAT, as the back-office network behind the VPN Concentrator (VPNC) can address the local LAN or WiFi network directly via the secure tunnel.

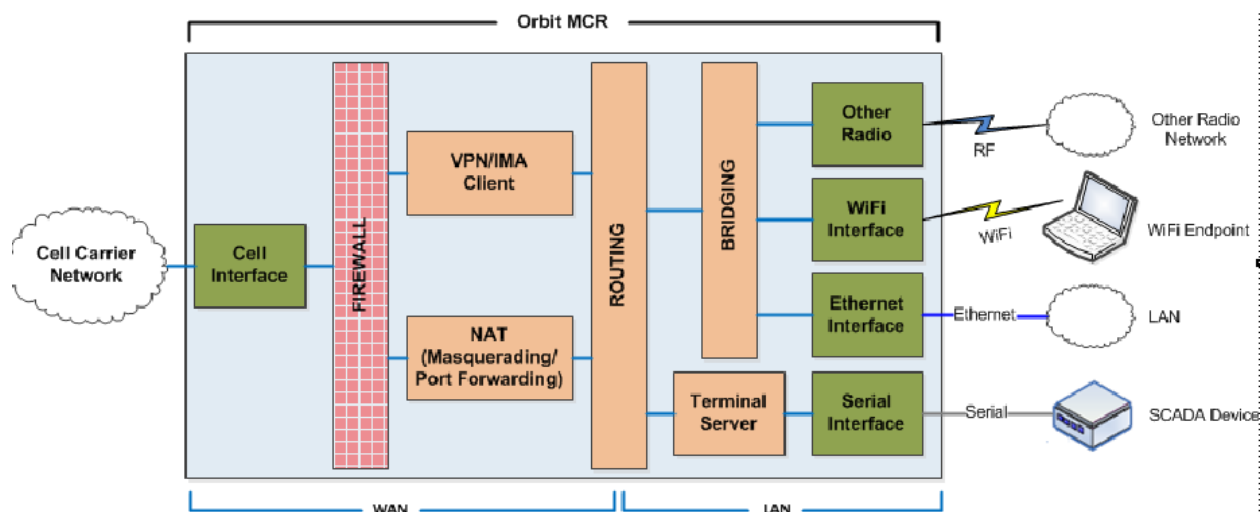


Figure 3-110. Bridging Functions Diagram

## Configuring

Creating a bridge interface and assigning it an IP address:

```
% set interfaces interface Bridge type bridge
% set interfaces interface Bridge bridge-settings ageing-time 500
% set interfaces interface Bridge ipv4 address 192.168.1.10 prefix-length 24
```

Adding LAN (ETH1) interface to the bridge:

```
% set interfaces interface Bridge bridge-settings members port ETH1
```

Adding WiFi interface (in Access Point mode) to the bridge:

```
% set interfaces interface Bridge bridge-settings members wifi-ap myssid
```

OR:

Adding WiFi interface (in Station mode) to the bridge:

```
% set interfaces interface Bridge bridge-settings members wifi-station
interface Wi-Fi
```

Removing LAN (ETH1) interface from the bridge:

```
% delete interfaces interface Bridge bridge-settings members port ETH1
```

Removing WiFi interface (in Access Point mode) from the bridge:

```
% delete interfaces interface Bridge bridge-settings members wifi-ap somessid
```

OR:

Removing WiFi interface (in Station mode) from the bridge:

```
% delete interfaces interface Bridge bridge-settings members wifi-station interface Wi-Fi
```

Removing the bridge interface:

```
% delete interfaces interface Bridge
```

## Monitoring

Ensure the CLI is in operational mode. Follow the example below to view the state and statistics of a bridge. In this example, bridge (Bridge) is bridging the LAN (ETH1).

```
> show interfaces-state interface Bridge
interfaces-state interface Bridge
```



```

type      bridge
admin-status up
oper-status up
if-index  1
phys-address 00:06:3d:07:96:82
statistics discontinuity-time 2014-02-12T14:29:35-05:00
statistics in-octets 263244716
statistics in-unicast-pkts 3231995
statistics in-multicast-pkts 0
statistics in-discards 4126
statistics in-errors 0
statistics out-octets 785224
statistics out-unicast-pkts 1362
statistics out-discards 0
statistics out-errors 0
ipv4 forwarding true
ipv4 mtu 1500

          PREFIX
IP          LENGTH ORIGIN
-----
10.10.10.141  23      static

          LINK LAYER
IP          ADDRESS      ORIGIN  STATE
-----
10.10.10.98 80:c1:6e:f0:3b:7a dynamic delay

bridge stp port ETH1
number      1
priority    0
state       forwarding
path-cost   100
designated-root 7035.04fe7fe36980
designated-cost 100
designated-bridge 8000.0002fd5dd280
designated-port 32783

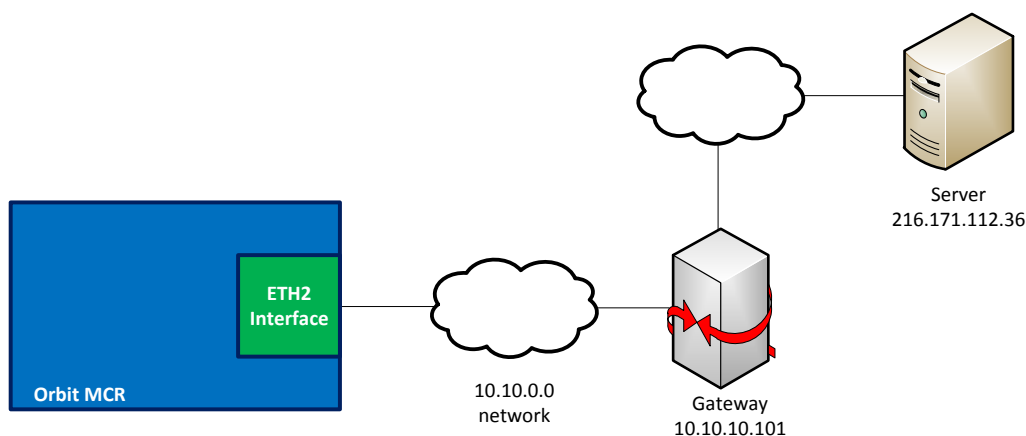
```

### 3.8.6 Routing

#### Understanding

The Orbit MCR can forward IP packets between routed interfaces, using a network path defined by the user. These user-defined network paths are known as static routes. A static route may be configured if data intended for a specific subnet or IP address must egress a particular onboard NIC.

As an example, consider a case where the unit is connected to a local network, 10.10.0.0/24, through its ETH2 port. This network contains a gateway at IP address 10.10.10.101. This gateway is also connected to another network 216.171.112.0/24, which has a NTP server. The Orbit MCR must use this network path to access an NTP server at IP address 216.171.112.36. A static route to network 216.171.112.0/24 via next-hop 10.10.10.101 (or a host-only route to 216.171.112.36/24 via next-hop 10.10.10.101) ensures that the unit can communicate with the NTP servers.



**Figure 3-111. Network Path to NTP Server**

In the diagram above, the gateway at 10.10.10.101 is referred to as the next hop, which means that it is the next routing device in the network path.

A default static route may also be configured. The unit will forward IP packets along this route when no other route in its routing table matches the packets' destination address. Typically, the route chosen as the default route contains a next-hop router that leads to the backhaul network.

## Configuring

Current routes may be viewed on the unit at any time by navigating to **Routing** on the left side of the screen. The unit's current routes are displayed under the **Status** tab.

The screenshot shows the 'Routing' configuration page with the 'Status' tab selected. Below the tabs is a 'General' section with a 'Routes' table. The table has columns for 'Dest Prefix', 'Next Hop', 'Outgoing Interface', and 'Source'. It lists four routes: 10.10.10.0/23 (Bridge, kernel), 192.110.11.0/24 (Wi-Fi, kernel), 206.246.122.250/32 (10.10.10.141, static), and fe80::/64 (kernel). A search bar and icons are at the top right of the table. The bottom right corner says 'Showing 1 to 4 of 4'.

Dest Prefix	Next Hop	Outgoing Interface	Source
10.10.10.0/23		Bridge	kernel
192.110.11.0/24		Wi-Fi	kernel
206.246.122.250/32	10.10.10.141	Bridge	static
fe80::/64			kernel

**Figure 3-112. Routing status screen**

The following information is available:

- **Dest Prefix** – Indicates the destination network's IP address and prefix in either IPv4 or IPv6 format.
- **Next Hop** – If known, the next hop router is displayed for each route.
- **Outgoing Interface** – This is the egress onboard network interface used for each route.
- **Source** – Routes are defined by either the kernel or the user (static).

To configure a static route, click the Static Routes option to navigate to **Routing ---> Basic Config / IPV4**.



## Routing ↻

Status Basic Config Advanced Config Actions

IPv4

### Route

Search  Add ... Delete Move ▾

ID	Description	Outgoing Interface	Preference	Verify Reachability - Operation	Dest Prefix	Next Hop
Table is empty						

IPv4 and IPv6 routes may be configured. The example that follows shows how to configure an IPv4 route. It is important to note that IPv6 routes are created with the same input parameters. The only difference is that the format of the **Dest Prefix** and **Next Hop** input parameters varies based on whether IPv4 or IPv6 is selected.

The example network path in Figure 3-1 requires an IPv4 address. When previous routes have been configured, the IPv4 Route table will display all user-configured IPv4 static routes are listed, as shown below.

Routing ↻

Status Basic Config Advanced Config Actions

IPv4

### Route

Search  Add ... Delete Move ▾

ID	Description	Outgoing Interface	Preference	Verify Reachability - Operation	Dest Prefix	Next Hop
2		GRE1	20		10.10.40.0/24	
10	Route to NTP Server	ETH2			216.171.112.36/32	10.10.10.101
1	Default Route	Bridge			0.0.0.0/32	192.168.1.1
220		Bridge			224.0.0.0/4	

Showing 1 to 4 of 4

**Figure 3-113. List of IPv4 static routes**

Delete any of the routes in the table by clicking on an entry to highlight it, and clicking the **Delete** button. To add a new route, click the **Add** button. The **Configure Route Details** menu appears.

### Configure Route Details

ID\*

Add Cancel

Create a numeric ID for the new route, and click **Add**. The ID acts as a label, is for reference only, and has no bearing on the route itself.





### Configure Route Details

1 Description

2 Outgoing Interface

3 Preference

Verify Reachability

4 Operation\*

5 Dest Prefix\*   
IPv4 destination prefix.

6 Next Hop    
IPv4 address of the next hop.

**Figure 3-114. Route Setup Menu**

A pop-up window bearing the route's ID appears with the following fields.

- **Description** – A user-defined string describing the route.
- **Outgoing Interface** — This dropdown box selects the onboard networking interface that outgoing IP traffic should use.

In the example above, this would be *ETH2*.

- **Preference** – Preference value of the route (lower value implies higher preference).
- **Verify Reachability Operation** - User defined network monitor operation to use for verifying reachability. Refer to section 3.8.19 on Page 320 for more information on used of this parameter.
- **Dest Prefix** – The IPv4 address and prefix of the route's destination.

A specific server is the destination in the example above, so the server's address *216.171.112.36* is used, with a prefix of *32*.

- **Next Hop** – As mentioned above, this is the next routing device that occurs in the network path.

The example above contains a next-hop router at *10.10.10.101*.

Once all items are configured appropriately, click **Save** in the upper left corner of the screen. Refresh the screen to see the new route in the routing table. If the route does not appear in the routing table, the unit has rejected the route as an invalid network path. Ensure that the configuration entered is valid.

The CLI can also be used to configure static routes. To configure the same route via the CLI, enter the following commands:

```
% set routing static-routes ipv4 route 10 description "Route to NTP Server" outgoing-interface  
ETH2 dest-prefix 216.171.112.36/32 next-hop 10.10.10.101
```

View the static routes with the command

```
% show routing  
static-routes {  
  ipv4 {  
    route 10 {
```



```

description "Route to NTP Server";
outgoing-interface ETH2;
dest-prefix 216.171.112.36/32;
next-hop 10.10.10.101;
}

```

Finally, save the changes.

```
% commit
```

## Default Static Route

To create a default static route, simply use a Dest Prefix of 0.0.0.0/0 when creating a new route, as shown below:

**Figure 3-115. Creating a default static route**

Configure a default static route from the CLI:

```

% set routing static-routes ipv4 route 1 description "Default route" outgoing-interface Bridge
  dest-prefix 0.0.0.0/0 next-hop 192.168.1.1
% commit

```

## Monitoring

As mentioned in **Configuring**, the unit's routes may be viewed on the web UI by navigating to **Routing**.

To view the list of routes in the CLI, first ensure the CLI is in operational mode. Follow the example below to view the state of the routing table:

```

> show routing

```

DEST PREFIX	OUTGOING NEXT HOP	INTERFACE	SOURCE
10.10.10.0/23	-	ETH2	kernel
192.110.111.0/24	-	Wi-Fi	kernel
192.168.0.0/24	-	Bridge	kernel
216.171.112.36/32	10.10.10.101	ETH2	static
fe80::/64	-		kernel
fe80::/64	-	Bridge	kernel
fe80::/64	-	ETH1	kernel
fe80::/64	-	Wi-Fi	kernel



## 3.8.7 Static Neighbor Entries

### Understanding

The Orbit MCR allows the configuration of static layer-2 MAC addresses. Normally IP neighbors are learned through protocols such as ARP or IPv6 neighbor discovery, however sometimes there is a need to statically configure an IP address to use a specific MAC address. This may occur if a neighbor does not respond to ARPs or neighbor solicitations, or responds incorrectly.

### Configuration

To add a static IPv4 neighbor to the Wi-Fi interface that maps the IP address 192.168.2.99 to the MAC address 00:11:22:33:44:55, first navigate to *Interfaces / Wi-Fi*.

Wi-Fi Interface ↻

Status Basic Config Advanced Config Actions

General  
Statistics  
Wi-Fi  
IPv4

Mtu 1492

**Address**

Search x [refresh] [search] [edit]

IP	Origin
192.168.2.10	static

Showing 1 to 1 of 1

**Neighbor**

Search x [refresh] [search] [edit]

IP	Link Layer Address	Origin	State
192.168.2.65	74:de:2b:a7:15:0a	static	reachable

Showing 1 to 1 of 1

Figure 3-116. WiFi Interface Menu

Both IPv4 and IPv6 neighbors may be created. This example uses IPv4, but IPv6 neighbors are created in a similar fashion. Click the **IPv4** menu shortcut to proceed.

The **Neighbor** list on the *Interfaces / Wi-Fi ---> Basic Config / IPv4* menu shows all user-configured neighbors.



## Wi-Fi Interface

Status Basic Config **Advanced Config** Actions

General  
Wi-Fi  
IPv4

IPv4

Enabled   
 Forwarding   
 Mtu

**Address**

Search  Add ... Delete

IP
192.168.2.10

Showing 1 to 1 of 1

**Neighbor**

Search  Add ... Delete

IP	Link Layer Address
192.168.2.65	74:de:2b:a7:15:0a

Showing 1 to 1 of 1

Dhcp

**Figure 3-117. List of user-configured neighbors**

To delete any of the neighbors in the table, click on an entry to highlight it, then click the *Delete* button.

To add a new neighbor, click the **Add** button. The **Configure New Neighbor** menu appears. Enter the neighbor's IP address and click **Add**.

**Configure Neighbor Details**

IP\*

**Figure 3-118. Add New Neighbor Menu**

Following the IP address, enter the neighbor's link layer address and then the **Finish** button.

**Configure Neighbor Details**

Link Layer Address\*

**Figure 3-119. Neighbor link layer address entry**

Once all items are configured appropriately, click **Save** in the upper left corner of the screen. The new neighbor will be populated into the **Neighbor** list.



## Wi-Fi Interface

Status Basic Config Advanced Config Actions

General  
Statistics  
Wi-Fi  
IPv4

Mtu 1492

**Address**

Search [x]

IP	Origin
192.168.2.10	static

Showing 1 to 1 of 1

**Neighbor**

Search [x]

IP	Link Layer Address	Origin	State
192.168.2.99	00:11:22:33:44:55	static	reachable
192.168.2.65	74:de:2b:a7:15:0a	static	reachable

Showing 1 to 2 of 2

The CLI can also be used to configure static routes. To configure the same route via the CLI, enter the following commands:

```
% set interfaces interface Bridge ipv4 neighbor 192.168.1.99 phys-address 00:11:22:33:44:55
```

## Monitoring

As mentioned above in **Configuring**, all of the user-defined neighbors on the web UI may be viewed by navigating to **Interfaces / Interface Name ---> Basic Config / Ipv4** viewing the Neighbor list.

To view the entire list of known IPv4 neighbors, including those learned automatically by the unit, the following CLI command would be used in operational mode:

```
> show interfaces-state interface ipv4 neighbor
```

	NAME	IP	LINK LAYER ADDRESS	ORIGIN	STATE
Bridge		192.168.1.3	00:80:c8:3b:97:bb	dynamic	reachable
		192.168.1.2	00:12:17:5c:4f:2d	dynamic	reachable
Wi-Fi		192.168.2.65	74:de:2b:a7:15:0a	static	reachable
		192.168.2.99	00:11:22:33:44:55	static	reachable

The following information is available.

- **Name** - Name of the interface.
- **IP** - The neighbor's IP address.
- **Link Layer Address** - The neighbor's link-layer address.
- **Origin** - Dynamic, static.
  - Dynamic neighbors are learned by the unit automatically through ARPs or neighbor solicitations.
  - Static neighbors are those added by the user.
- **State** - Incomplete, reachable, stale, delay, probe.
  - Incomplete - Address resolution is still in progress and the neighbor's link-layer address is unknown.
  - Reachable - The neighbor is currently reachable.



- Stale - The neighbor is not currently unreachable. The unit reevaluates the state of stale neighbors the next time it attempts to send traffic to them.
- Delay - The neighbor was formerly in a Stale state, and a recent attempt to send traffic to it failed.
- Probe - The neighbor was formerly in a Delay state, and the unit is currently sending ARPs/neighbor solicitations in an attempt to reach the neighbor.

### 3.8.8 Access Control List (Packet Filtering / Firewall)

#### Understanding

Packet filtering is a component of the firewall service. It can be used to permit or deny incoming or outgoing traffic on an interface.

Packet filtering allows configuring and applying a packet filter (also called Access Control List, or ACL) to incoming or outgoing traffic on an interface. A filter is a set of one or more rules. Each rule consists of two parts:

- Matching criteria that a packet must satisfy for the rule to be applied. Matching criteria consists of various parameters like protocol, source/destination addresses and ports etc.
- Actions that specify what to do with the packet when the matching criteria is met, for example, to drop or accept the packet.

The filter can then be applied to an interface in the incoming or outgoing direction. Typically, different filters are applied in the incoming and outgoing direction on an interface. For example, a filter applied to the cellular (WAN) interface of the MCR is typically very restrictive, permitting only a small set of traffic to enter the unit, whereas outgoing filter might permit all outgoing traffic etc.

The MCR includes the four pre-configured filters shown below:

**Table 3-18. Predefined Filter Names and Default Settings**

Filter Name	Actions
IN_TRUSTED	Allow ingress of all traffic
IN_UNTRUSTED	Allow ingress of ICMP traffic, DNS response traffic, drop all else
OUT_TRUSTED	Allow egress of all traffic
OUT_UNTRUSTED	Allow traffic originating from the interface to which this filter has been applied and from addresses specified in LOCAL-NETS address-set (typically LAN network).

If the Firewall service is enabled, filters specifying ingress and egress rules must be applied to each network interface on the device. The MCR's network interfaces allow no traffic to pass unless a filter is applied to each one allowing them to do so. Except for the Cell, each network interface on the MCR is preconfigured with IN\_TRUSTED as an input filter, and OUT\_TRUSTED as an output filter. This allows all traffic to enter and exit the unit.

The diagrams below provide a simplified view of packet flow for various categories of traffic flows going in and out of the MCR unit when packet filtering is enabled.

Figure 3-120 shows the flow of packets terminating at the unit, such as device management traffic using SSH or NETCONF protocol terminating at local device management process within the unit.



**Figure 3-120. Packets Terminated at the Unit**

Figure 3-121 shows flow of packets originating from the unit, such as DNS queries and/or VPN connection setup traffic originating from local VPN service within the unit.



**Figure 3-121. Packets Originating from the Unit**

Figure 3-122 shows the flow of packets being forwarded (routed) through the unit, such as IP packets arriving inside IPsec VPN tunnel, being routed from cellular WAN to the local Ethernet interface.



**Figure 3-122. Packets Being Forwarded Through the Unit**



---

**NOTE** If the firewall service is enabled and no filter is applied to an interface, then both incoming and outgoing traffic is dropped on that interface.

---

## Configuring

Packet filter configuration on the unit involves following these high level steps:

1. Create a filter and choose its default policy. For example, there are usually two ways to organize a filter:
  - Create a "restrictive" filter. The first rules are added to permit the desired types of traffic, and a final rule, or default policy, is created that denies all other traffic. The example filter rules below permit SSH traffic on TCP port 22, and ICMP messages such as pings and routing error notifications. All other traffic is denied.
    - Rule 1 = permit protocol=tcp, dst port=22
    - Rule 2 = permit protocol=icmp
    - Rule 3 = deny everything
  - Or create a "permissive" filter. The first rules are added to deny the undesired types of traffic, and a final rule, or default policy, is created that permits all other traffic. The example filter rules below deny HTTP traffic on TCP port 80, and ICMP message such as pings and routing error notifications. All other traffic is permitted.
    - Rule 1 = deny protocol=tcp, dst port=80
    - Rule 2 = deny protocol=icmp
    - Rule 3 = permit everything
2. Apply the filter to input or output direction of the interface. This selection depends on whether the rules should apply to traffic that ingresses or egresses the device.



## Example

The following example describes the step-by-step configuration of example input and output filters that can be applied to cellular interface of the MCR. Since the cellular interface is connected to public cellular network, which is inherently an untrusted network, the cellular interface can be considered untrusted as well. Therefore, this example permits all outgoing cellular traffic, but restricts incoming traffic. Incoming IPsec tunnel traffic is allowed, as are UDP services DNS, NTP, and IKE (to allow IPsec connection setup). Incoming TCP services SSH and NETCONF are also permitted to allow management of the MCR via the cellular interface. All other incoming traffic is denied.

## Using the Access Control List Wizard

The Access Control List Wizard is the web UI's simplest way to create, delete, and manage packet filtering rules. First, navigate to **Wizards** and click **Access Control List (Filter)** from either the navigation bar or the main Wizards page.

### Configuration Wizards

The screenshot shows a web interface titled "Configuration Wizards". It contains three main sections, each with a title and a list of wizard steps:

- Initial Setup Wizard**
  - Initial Setup
- Services**
  - VPN Setup
- Networking**
  - Basic Interface Setup  
To help configure basic IP and connectivity settings.
  - Access Control List (Filter)  
To help configure filters on one or more interfaces
  - Destination NAT (Port Forwarding)  
To help configure port forwarding on one or more interfaces
  - Source NAT (Masquerading)  
To help configure source NAT (Masquerading) on one or more interfaces.
  - Static NAT (one-to-one NAT)  
To help configure static NAT (one-to-one NAT) on one or more interfaces

**Figure 3-123. Wizards List**

The Access Control List Wizard Introduction page appears. Click **Next** to continue.





## Access Control List (Filter)

### MDS Orbit Firewall/NAT Configuration Wizard

This wizard provides set-up support for:

1. Access Control List (Filter)

A summary of all the changes will be provided at the end.

Cancel

Back Next

**Figure 3-124. Access Control List (Filter) Introduction**

The existing filters will be displayed.

## Access Control List (Filter)

Please select the filter that you would like to configure or click 'Add' to create a new one.

<input type="checkbox"/>	Name	Description
<input type="checkbox"/>	IN_TRUSTED	ACL Filter
<input type="checkbox"/>	IN_UNTRUSTED	ACL Filter
<input type="checkbox"/>	OUT_TRUSTED	ACL Filter
<input type="checkbox"/>	OUT_UNTRUSTED	ACL Filter

Delete Selected

Edit Selected

Add

Cancel

Back Next

**Figure 3-125. List of existing packet filters**

The wizard displays the list of existing packet filtering rules on the device. The MCR comes with four pre-configured filters: IN\_TRUSTED, IN\_UNTRUSTED, OUT\_TRUSTED, and OUT\_UNTRUSTED.

Existing filters may be edited or deleted, or a new one may be added.

To create a new filter, click **Add**, then **Yes** to verify the creation of a new filter. Enter the name of the new filter, for example “**Cell\_Input\_Filter**”. Click **OK** to continue.

Are you sure you would like to create a new filter?

Yes No

Please type in the new filter name

Cell\_Input\_Filter

OK Cancel



A packet filter consists of a list of rules. Rules are listed in the order of priority. To change the priority of rules in the list, click the up or down buttons in the Order column. Rules may be added or deleted.

When creating a new filter, rules must be added. Using the "Add new rule" button, enter each new rule as required.

### Access Control List (Filter)

Cell\_Input\_Filter

Rules will be processed in the same order in which they are defined.

<input type="checkbox"/>	Order	Protocol	Source	Destination	Actions
Delete selected rules					
Add new rule					
Cancel					
Back Next					

### Access Control List (Filter)

Cell\_Input\_Filter

Rules will be processed in the same order in which they are defined.

<input type="checkbox"/>	Order	Protocol	Source	Destination	Actions
<input type="checkbox"/>	↑ ↓	ICMP N/A	Source IP Mode: All Source Port Mode: Services Services: eg: dhcp,dns,ftp	Destination IP Mode: All Destination Port Mode: Services Services: eg: dhcp,dns,ftp	Actions: Accept Log: Level: Info, Prefix:
<input type="checkbox"/>	↑ ↓	All	Source IP Mode: All Source Port Mode: Services Services: eg: dhcp,dns,ftp	Destination IP Mode: All Destination Port Mode: Services Services: eg: dhcp,dns,ftp	Actions: Drop Log: Level: Info, Prefix:

Delete selected rules Add new rule

**Figure 3-126. Editing/creating packet filter rules**

The following options are available.

- **Order** – Click the arrows to sort rules in order of priority. Rules with higher priority are applied before rules with lower priority; rule sets containing more than one rule should be sorted accordingly.
- **Protocol** – *All, SCTP, TCP, UDP, ICMP, ESP*. Specifies the IP protocol of traffic that the rule should be applied to.
- **ICMP** - When selected, the rule will only apply to that specific ICMP message only. For ICMP message type definitions, see *RFC792*, available from the Internet Engineering Task Force, <http://www.ietf.org>
  - N/A - the rule will be applied to all ICMP protocol messages.
  - Destination Unreachable



- Echo Request
- Echo Reply
- Address Mask Request
- Address Mask Reply
- Parameter Problem
- Redirect
- Router Advertisement
- Router Solicitation
- Source Quench
- Time Exceeded
- Timestamp Request
- Timestamp Reply.
- **Source IP** – Apply rule to traffic that originates at a specific source address or addresses.
  - **Mode** – Address, Address Range, Address Set, Not Address, Not Address Range, Not Address Set.
    - All – Apply rule regardless of source address.
    - Address - Apply rule to a specific source address and prefix.
    - Address Range – Apply rule to a range of source addresses.
    - Address Set – Apply rule to a non-contiguous set of source addresses.
    - Not Address - Apply rule to traffic that does *not* originate from a specific source address and prefix.
    - Not Address Range – Apply rule to traffic that does *not* originate from a source address range.
    - Not Address Set – Apply rule to traffic that does *not* originate from a non-contiguous set of source addresses.
- **Source Port** – Apply rule to traffic that originates at a specific source port. This option is available only with protocols *SCTP*, *TCP*, and *UDP*.
- **Services** – Services, Port Range, Not Services, Not Port Range.
  - **Services** – Apply rule to traffic originating from one or more designated well-known service source ports. The services must be specified by name and separated by commas.
    - Port Range – Apply rule to traffic originating from a specific source port or set of ports.
    - Not Services – Apply rule to traffic that does *not* originate from one or more designated well-known service source ports. The services must be specified by name and separated by commas.
    - Not Port Range – Apply rule to traffic that does *not* originate from a specific source port or set of ports.
- **Destination IP** – Apply rule to traffic intended for a specific destination address or addresses.
  - **Mode** – Address, Address Range, Address Set, Not Address, Not Address Range, Not Address Set.
    - All – Apply rule regardless of destination address.
    - Address - Apply rule to a specific destination address and prefix.
    - Address Range – Apply rule to a range of destination addresses.
    - Address Set – Apply rule to a non-contiguous set of destination addresses.



- Not Address - Apply rule to traffic that is *not* intended for a specific destination address and prefix.
- Not Address Range – Apply rule to traffic that is *not* intended for a specific destination address range.
- Not Address Set – Apply rule to traffic that is *not* intended for a non-contiguous set of destination addresses.
- **Destination Port** – Apply rule to traffic intended for a specific destination port. This option is available only with protocols *SCTP*, *TCP*, and *UDP*.
- **Services** – Services, Port Range, Not Services, Not Port Range.
  - **Services** – Apply rule to traffic intended for one or more designated well-known service destination ports. The services must be specified by name and separated by commas.
    - Port Range – Apply rule to traffic intended for a specific destination port or set of ports.
    - Not Services – Apply rule to traffic that is *not* intended for one or more designated well-known service destination ports. The services must be specified by name and separated by commas.
    - Not Port Range – Apply rule to traffic that is *not* intended for a specific destination port or set of ports.
- **Actions** – *Accept*, *Drop*, *Reject*. Specifies what should be done with packets that match the rule.
  - Accept – Allow packets to ingress or egress the unit.
  - Drop – Block packets from ingress or egress.
  - Reject – Block packets from ingress or egress and send an error message to the sender. When *ICMP* protocol is selected, a rejection message may be chosen.
  - Reject Type – Net unreachable, Host unreachable, Port unreachable, Proto unreachable, Net prohibited, Host prohibited, Admin prohibited
- **Log** – *Optional*. Allows packets that meet the rule to be logged to the event log.
  - **Level** – Emergency, Alert, Critical, Error, Warning, Notice, Info, Debug.
  - **Prefix** – Enter a text string to prepend to generated log entries.

### Allow Select Cell Inbound traffic

In this example, the input filter will be restrictive and permit only some types of traffic: IPsec tunnel traffic, UDP services DNS, NTP, and IKE (to allow IPsec connection setup), and TCP services SSH and NETCONF (to allow management of the MCR).

To create a rule to permit IPsec tunnel traffic, select **Protocol** ESP and ensure that **Action** is set to Accept. The **Log Level** can be set to Debug, unless incoming IPsec traffic is of interest.

Order	Protocol	Source	Destination	Actions
<input type="checkbox"/>	ESP	Source IP: All Source Port: Services (eg: dhcp,dns,ftp)	Destination IP: All Destination Port: Services (eg: dhcp,dns,ftp)	Actions: Accept Log: Level: Debug, Prefix:

**Figure 3-127. Creation of a packet filter rule to allow IPsec connections**

Next, click **Add new rule** to create a rule to allow the desired UDP services. For this rule, select **Protocol** UDP and set **Source Port** to Services. The services must be entered as a comma-separated list. Since this example permits UDP services DNS, NTP, and IKE, enter dns, ntp, Ike in the textbox next to **Services**.



Ensure that **Actions** is set to **Accept**. Again, **Log Level** can be set to **Debug** unless there is a need to view incoming UDP connections.

Note that the UDP rule appears below the ESP rule in the rule list. This indicates that the ESP rule will be applied first, and then the UDP rule. This is not a problem since the two rules are not in conflict.

The screenshot shows the configuration for a packet filter rule for UDP traffic. The rule is named 'UDP'. The Source IP is set to 'All'. The Destination IP is set to 'All'. The Source Port is set to 'Services' with a list of services: 'dns, ike, ntp'. The Destination Port is set to 'Services' with a list of services: 'eg: dhcp, dns, ftp'. The Actions are set to 'Accept'. The Log Level is set to 'Debug'.

**Figure 3-128. Creation of a packet filter rule for inbound UDP traffic**

The next rule in this example will be used for the TCP services SSH and NETCONF. Click **Add new rule** and select **Protocol TCP**. Since SSH and NETCONF traffic is used to manage the MCR, the traffic terminates at the MCR. This means that the incoming traffic will have these well-known service ports as its destination port. Set **Destination Port** to *Services*, and enter netconf, Ssh in the textbox next to **Services**. Again, ensure that **Actions** is set to *Accept*, and **Log Level** can be set to *Debug*.

The screenshot shows the configuration for a packet filter rule for inbound TCP traffic. The rule is named 'TCP'. The Source IP is set to 'All'. The Destination IP is set to 'All'. The Source Port is set to 'Services' with a list of services: 'eg: dhcp, dns, ftp'. The Destination Port is set to 'Services' with a list of services: 'netconf, ssh'. The Actions are set to 'Accept'. The Log Level is set to 'Debug'.

**Figure 3-129. Creation of a packet filter rule for inbound TCP traffic**

The last step in the creation of a restrictive filter is a default rule to deny all traffic that does not match any of the previous rules. To do this, click **Add new rule**, select **Protocol All**, and set **Actions** to *Drop*. The **Log Level** is once again set to *Debug*. This rule must be at the last on the rule list. Any rules added after this last rule will have no effect, as they would match “any” traffic and be dropped.

The screenshot shows the configuration for a default restrictive packet filter rule for inbound traffic. The rule is named 'All'. The Source IP is set to 'All'. The Destination IP is set to 'All'. The Source Port is set to 'Services' with a list of services: 'eg: dhcp, dns, ftp'. The Destination Port is set to 'Services' with a list of services: 'eg: dhcp, dns, ftp'. The Actions are set to 'Drop'. The Log Level is set to 'Debug'.

**Figure 3-130. Creation of a default restrictive packet filter rule for inbound traffic**

Once all changes are finished, click **Back** to return to the list of packet filters and create another.



## Access Control List (Filter)

Cell\_Inbound\_Traffic

Rules will be processed in the same order in which they are defined.

Order	Protocol	Source	Destination	Actions
1	ESP	Source IP: Mode: All Source Port: Mode: Services Services: eg: dhcp,dns,ftp	Destination IP: Mode: All Destination Port: Mode: Services Services: eg: dhcp,dns,ftp	Actions: Accept Log: Level: Debug, Prefix:
2	UDP	Source IP: Mode: All Source Port: Mode: Services Services: dns,ike,ntp	Destination IP: Mode: All Destination Port: Mode: Services Services: eg: dhcp,dns,ftp	Actions: Accept Log: Level: Debug, Prefix:
3	TCP	Source IP: Mode: All Source Port: Mode: Services Services: eg: dhcp,dns,ftp	Destination IP: Mode: All Destination Port: Mode: Services Services: netconf,ssh	Actions: Accept Log: Level: Debug, Prefix:
4	All	Source IP: Mode: All Source Port: Mode: Services Services: eg: dhcp,dns,ftp	Destination IP: Mode: All Destination Port: Mode: Services Services: eg: dhcp,dns,ftp	Actions: Drop Log: Level: Debug, Prefix:

Figure 3-131. Completed rules for inbound IPsec traffic

### Permit Cell Outbound Traffic

The network in this example requires that the cellular interface permit all outgoing traffic. A filter must be applied to the cellular interface that allows this. The preconfigured OUT\_TRUSTED filter does this already, but since the cellular interface in this example is untrusted, we anticipate that it will require outbound traffic restrictions in the future. To allow interface-specific customization, we create a new packet filter.

To create a new filter, click **Add**, then **Yes** to verify the creation of a new filter. Enter the name of the new filter, for example “**Cell\_Output\_Filter**”. Click **OK** to continue. Using the “**Add new rule**” button enter each new rule as required.

After clicking **Add New Rule**, the rule creation menu appears. Select **Protocol All** and **Actions Accept**. This is a permissive filter, which allows all traffic. Later on, if needed, this filter can be enhanced to deny certain traffic from exiting the cellular interface.



## Access Control List (Filter)

Cell\_Output\_Traffic

Rules will be processed in the same order in which they are defined.

Order	Protocol	Source	Destination	Actions
1	All	Source IP: Mode: All Source Port: Mode: Services Services: eg: dhcp,dns,ftp	Destination IP: Mode: All Destination Port: Mode: Services Services: eg: dhcp,dns,ftp	Actions: Accept Log: Level: Debug Prefix:

**Figure 3-132. Creation of a filter rule to allow all traffic**

Since there are no more filters to add, click **Next** to proceed to **Interface Selection**.

## Access Control List (Filter)

Apply filters to incoming and outgoing traffic on interface(s) and IPsec connections.

Name	Type	In	Out
Bridge	bridge	IN_TRUSTED	OUT_TRUSTED
Cell	cellular	Cell Inbound Filter	Cell Outbound Filter
ETH2	ethernet	IN_TRUSTED	OUT_TRUSTED
Wi-Fi	wifi	IN_TRUSTED	OUT_TRUSTED

**Figure 3-133. Interface Selection Menu**

The **Interface Selection** menu shows each network interface and IPsec connection present on the device. When the Firewall service is running, each network interface and IPsec connection on the device must be assigned an input and output packet filter. Otherwise, no traffic will flow. By default, each network device uses IN\_TRUSTED and OUT\_TRUSTED as filters. Since the filters just created in this example are intended for the cellular interface, click the **In** dropdown box next to the **Cell** interface and select the newly created input filter. Next, click the **Out** dropdown next to the **Cell** interface and select the newly created output filter. Click **Next** to continue.



## Access Control List (Filter)

Summary			
Keypath	Change Type	Old Value	New Value
filter(Cell_Outbound_Filter)/rule(1)/actions/action	value_set		accept
filter(Cell_Outbound_Filter)/rule(1)/actions	created		
filter(Cell_Outbound_Filter)/rule(1)/match/protocol	value_set		all
filter(Cell_Outbound_Filter)/rule(1)	created		
filter(Cell_Outbound_Filter)	created		
filter(Cell_Inbound_Filter)/rule(4)/actions/action	value_set		drop
filter(Cell_Inbound_Filter)/rule(4)/actions	created		
filter(Cell_Inbound_Filter)/rule(4)/match/protocol	value_set		all
filter(Cell_Inbound_Filter)/rule(4)	created		
filter(Cell_Inbound_Filter)/rule(3)/actions/action	value_set		accept
filter(Cell_Inbound_Filter)/rule(3)/actions	created		
filter(Cell_Inbound_Filter)/rule(3)/match/protocol	value_set		tcp
filter(Cell_Inbound_Filter)/rule(3)/match/dst-port/services	value_set		netconf,ssh
filter(Cell_Inbound_Filter)/rule(3)/match/dst-port	created		
filter(Cell_Inbound_Filter)/rule(3)	created		
filter(Cell_Inbound_Filter)/rule(2)/actions/action	value_set		accept
filter(Cell_Inbound_Filter)/rule(2)/actions	created		

**Figure 3-134. Subset of Access Control Wizard summary page**

A summary page appears that displays the items in the configuration's data model that were changed, and type of changes that occurred. To save and apply the changes, click **Submit**.

To view the list of packet filters that exist on the device at any time, navigate to **Firewall ---> Basic Config**, and view the list of filters in the **Filter** tab.

Change the packet filters applied to a network interface by navigating to **Interfaces** and click on the desired interface from the navigation bar. Navigate to the **Basic Config** tab. The input and output filters appear in the **Filter** drop-down.

**Cell Interface**

Status Basic Config Advanced Config Actions

- ▶ General
- ▶ Cellular
- ▶ IPv4
- ▼ Filter
 

**Filter**

Input

Output
- ▶ Nat
- ▶ QoS

**Figure 3-135. Cell interface, Filter menu**





## Using the CLI

To use the CLI to create and apply the same packet filters as the example above, first change to CLI configuration mode, and follow the steps below. Change to CLI configuration mode:

1. Enable firewall service  
**% set services firewall enabled true**
2. Create a “restrictive” filter named *Cell\_Inbound\_Traffic* to indicate that this filter has been designed to be applied to an untrusted cellular interface of MCR. The cellular interface can be considered untrusted as it is connected to public cellular network, which is inherently an untrusted network.  
**% set services firewall filter Cell\_Inbound\_Traffic**
3. Create rule to permit encrypted IPsec tunnel traffic i.e. traffic with protocol=ESP  
**% set services firewall filter Cell\_Inbound\_Traffic rule 1 match protocol esp**  
**% set services firewall filter Cell\_Inbound\_Traffic rule 1 actions action accept**
4. Create rule to permit traffic for the following UDP services: DNS, NTP and IKE (to allow IPsec connection setup).  
**% set services firewall filter Cell\_Inbound\_Traffic rule 2 match protocol udp src-port services [dns ike ntp]**  
**% set services firewall filter Cell\_Inbound\_Traffic rule 2 actions action accept**
5. Create rule to permit traffic for following TCP services: SSH and NETCONF (to allow management of MCR):  
**% set services firewall filter Cell\_Inbound\_Traffic rule 3 match protocol tcp dst-port services [netconf ssh]**  
**% set services firewall filter Cell\_Inbound\_Traffic rule 3 actions action accept**

---

**NOTE** The rule stated in step 5 permits SSH or NETCONF connection addressed to the cellular interface’s IP address. If it is desired that SSH or NETCONF connection only be allowed via the VPN tunnel, then remove rule 3 and instead apply appropriate filter to IPsec connection.

---

6. Create the last rule for this “restrictive” filter to deny everything else. Note that rules are applied in ascending order using rule IDs. Any rules added after this last rule will have no effect, as they would match “any” traffic and be dropped. In this example rule ID 10 is chosen. This facilitates the insertion of new rules prior to this last one to support future new traffic types.  
**% set services firewall filter Cell\_Inbound\_Traffic rule 10 match protocol all**  
**% set services firewall filter Cell\_Inbound\_Traffic rule 10 actions action drop**
7. Apply this filter to incoming direction on cellular interface “Cell”.  
**% set interfaces interface Cell filter input Cell\_Inbound\_Traffic**
8. Create a “permissive” filter that permits all traffic. Later on, if needed, this filter can be enhanced to deny certain traffic from getting out of the cellular interface.  
**% set services firewall filter Cell\_Outbound\_Filter rule 10 match protocol all**  
**% set services firewall filter Cell\_Outbound\_Filter rule 10 actions action accept**
9. Apply this filter to outgoing direction on cellular interface “Cell”.  
**% set interfaces interface Cell filter output Cell\_Outbound\_Filter**
10. Commit configuration and exit configuration mode.  
**% commit**  
**Commit complete.**

## Monitoring

At this time there are no commands to monitor traffic statistics for packets being dropped or permitted by the firewall. This feature may be added to future revisions of firmware.



### 3.8.9 Source NAT (Masquerading)

#### Understanding

Network address translation is a component of the firewall service provided on the Orbit MCR. NAT allows mapping of private IP addresses to public IP addresses and vice versa. There are three basic kinds of network address translation:

- Source NAT
- Destination NAT
- Static NAT

#### Source NAT

Source NAT performs translation of source IP address of the traffic egressing an interface. This is typically used to provide many-to-one translation (also called masquerading) of a private network behind the MCR to allow hosts on that private network to access a host on the public network. (See Figure 3-136.) In the figure below, this host is HOST-B. From HOST-B's point of view, all traffic originating from hosts in the private network will appear to have originated from a single IP address: The IP address of the public interface of the MCR, typically the cellular interface. To allow return IP traffic for UDP/TCP connections to be delivered to the right private host, the MCR also performs source port translation. Therefore, masquerading consists of Network Address and Port Translation (NAPT).

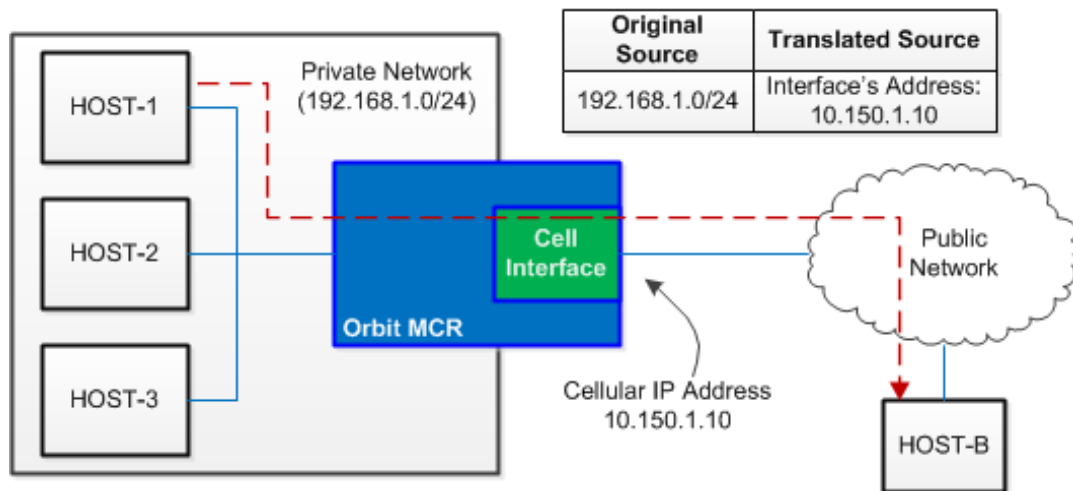


Figure 3-136. Source NAT Translation of IP Address

In the diagram above, traffic from HOST-1, HOST-2, and HOST-3 on the private network 192.168.1.0/24 egresses the MCR's cellular interface with a translated source IP address of 10.150.1.10.

Figure 3-137 shows the flow of packets being masqueraded (source NATed) through the MCR unit.

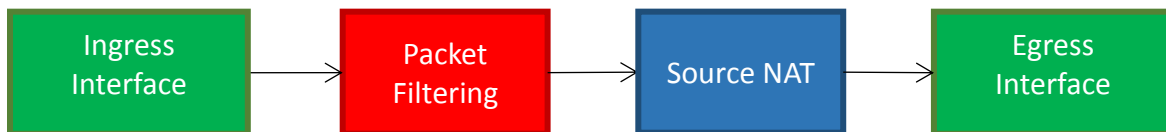


Figure 3-137. Packets Being Masqueraded Through MCR

#### Configuring

Source NAT configuration on MCR involves following high level steps:

1. Create a source NAT rule-set.
2. Add a rule to perform source NAT on the public interface.

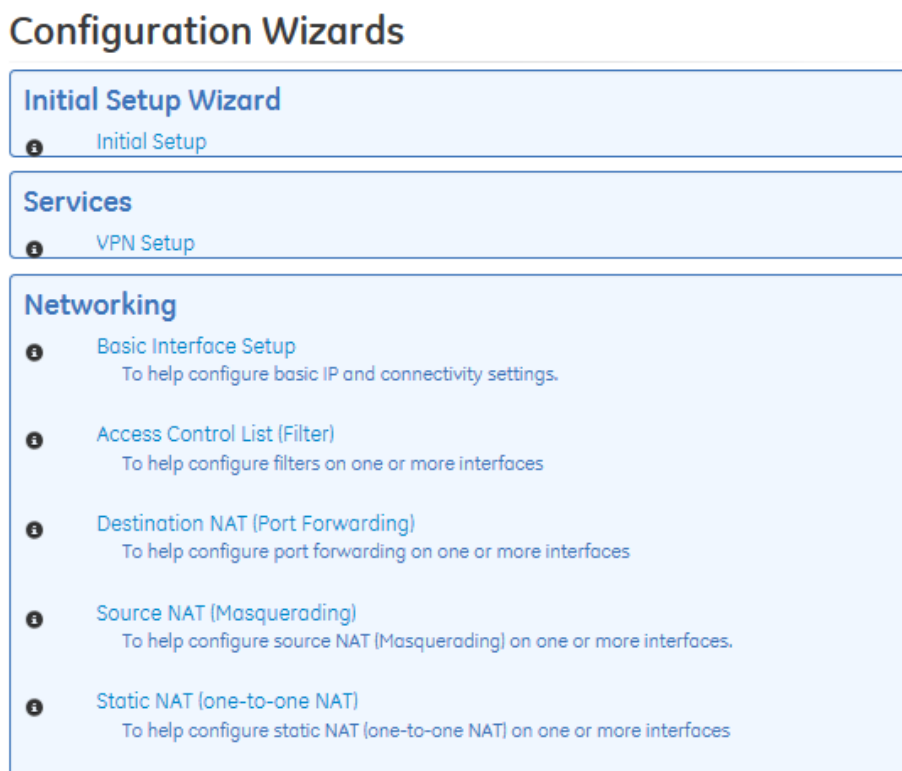


3. Apply the source NAT rule-set to the public interface.

To perform the masquerading shown in the example network in Understanding above, a source NAT rule would be created and applied to the cell interface. The following example will illustrate the necessary steps in three ways: Using the Source NAT wizard, through the web UI, and via the CLI.

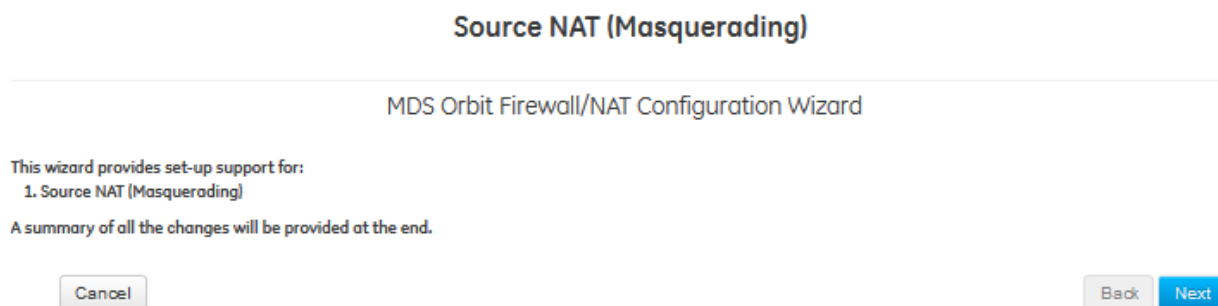
## Using the Source NAT Wizard

The Source NAT Wizard allows the creation or editing of Source NAT rule sets. First, navigate to **Wizards** and click **Source NAT/Masquerading** from either the navigation bar or the main Wizards page.



**Figure 3-138. Configuration Wizards Menu**

The **Source NAT Introduction** page appears.





Click **Next** to continue.

### Source NAT (Masquerading)

Please select the Source NAT rule-set that you would like to configure or click 'Add' to create a new one.

<input type="checkbox"/>	Name	Description
<input type="checkbox"/>	MASQ	SRC NAT

**Figure 3-139. Source NAT Rule Sets**

The first page in the Source NAT Wizard shows all source NAT rule sets present on the device. Click the checkbox next to an existing rule set and click **Edit Selected** or **Delete Selected** to modify existing rule sets.

To create a new rule set, click the **Add** button.

Are you sure you would like to create a new SRC NAT ruleset?

---

Please type in the new SRC NAT name

Example|

Enter a name and click **Ok** to continue.

### Source NAT (Masquerading)

Example

Rules will be processed in the same order in which they are defined.

<input type="checkbox"/>	Order	Source IP	Destination IP	Source NAT
<input type="button" value="Delete selected rules"/>				
<input type="button" value="Add new rule"/>				

**Figure 3-140. List of rules in current source NAT rule set**

The next menu shows all rules contained within the new rule set. Since the rule set is new, it has none. Click **Add New Rule** to add one. The rule creation menu appears.



## Source NAT (Masquerading)

Example

Rules will be processed in the same order in which they are defined.

<input type="checkbox"/>	Order	Source IP	Destination IP	Source NAT
<input type="checkbox"/>	<input type="button" value="↑"/> <input type="button" value="↓"/>	Source IP Mode: All	Destination IP Mode: All	Interface

This menu displays a view of all rules created for the current rule set, as well as a means to create new ones. The following options are available.

- **Order** – Click the arrows to sort rules in order of priority. Rules with higher priority are applied before rules with lower priority; rule sets containing more than one rule should be sorted accordingly.
- **Source IP** – Apply rule to traffic that originates at a specific address or addresses.
  - **Mode** – options:
    - All – Apply rule regardless of source address. (The example above uses this configuration.)
    - Address - Apply rule to a specific source address and prefix.
    - Address Range – Apply rule to a range of source addresses.
    - Address Set – Apply rule to a non-contiguous set of source addresses.
    - Not Address - Apply rule to traffic that does *not* originate from a specific address and prefix.
    - Not Address Range – Apply rule to traffic that does *not* originate from a specific source address range.
    - Not Address Set – Apply rule to traffic that does not originate within a non-contiguous set of source addresses.
- **Destination IP** – Apply rule to traffic that ingresses the unit at a specific address or addresses.
  - **Mode** – Options:
    - All – Apply rule regardless of destination address. (The example above uses this configuration.)
    - Address - Apply rule to a specific destination address and prefix.
    - Address Range – Apply rule to a range of destination addresses.
    - Address Set – Apply rule to a non-contiguous set of destination addresses.
    - Not Address - Apply rule to traffic that does *not* ingress at a specific address and prefix.
    - Not Address Range – Apply rule to traffic that does *not* ingress at a specific destination address range.
    - Not Address Set – Apply rule to traffic that does *not* ingress at a non-contiguous set of destination address
  - **Source NAT** – Interface, Address.
    - Interface – - Translate the source address to the address of the interface to which this rule-set has been applied. (The example **above** uses this configuration).
    - Address – Translate the source address to the specified address.



Once all selections are complete, click **Next** to continue. The **Interface Selection** menu appears.

### Source NAT (Masquerading)

Apply source NAT rule-sets to outgoing traffic on the interface(s).

Name	Type	Port Forwarding Rule-Set
Bridge	bridge	<input type="text"/>
Cell	cellular	<input type="text" value="Example"/>
ETH2	ethernet	<input type="text"/>
Wi-Fi	wifi	<input type="text"/>

**Figure 3-141. Interface Selection Menu**

The Interface Selection menu allows the created rule set to be applied to one or more interfaces. To do so, click the drop-down box next to the desired interface and select the rule set name. In the example above, the new rule set should be applied to the cellular interface. Click **Next** to continue.

### Source NAT (Masquerading)

#### Summary

Keypath	Change Type	Old value	New Value
nat/source/rule-set{Example}/rule{1}/source-nat/interface	created		
nat/source/rule-set{Example}/rule{1}	created		
nat/source/rule-set{Example}	created		
/if/interfaces/interface{Cell}/nat/source	value_set	MASQ	Example

**Figure 3-142. Source NAT Wizard Summary Page**

A summary page appears that displays the changed items in the configuration’s data model, and the types of changes that occurred. To save and apply the changes, click **Submit**.

## Using the Web UI

The following process creates the same Source NAT rule set as the example above, using the web UI instead of the Source NAT Wizard. Before using source NAT, the firewall service must be enabled.

Select the **Firewall** system tab. Check the box next to *Enabled* on the **Basic Config** tab and click **Save** in the upper left corner of the screen.

### Firewall Service

---

Enabled

**Figure 3-143. Enabling the Firewall service**



Click on the **Source NAT** drop-down to open the Source NAT menu.

## Firewall Service



Figure 3-144. NAT menu

## Firewall Service

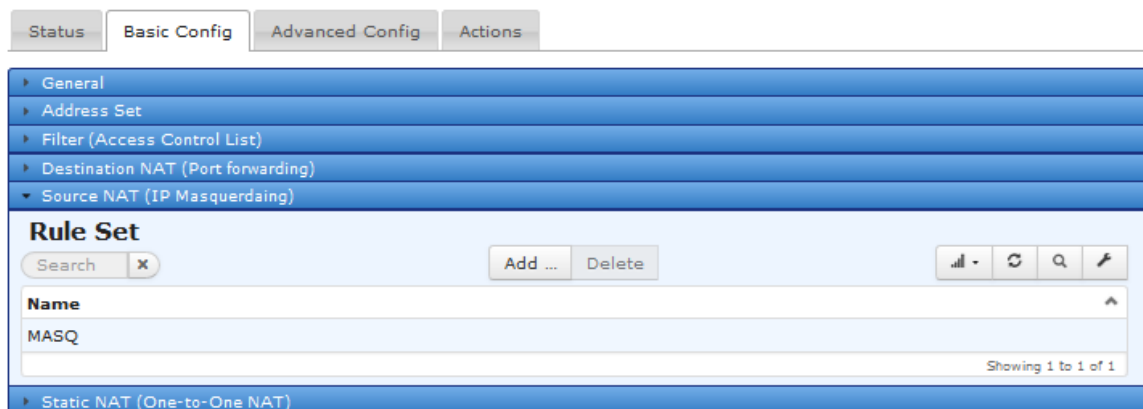


Figure 3-145. Source NAT Menu

The **Source NAT** menu displays all current source NAT rule sets on the device. To edit an existing rule set, simply click on the rule set's name. To delete an existing rule set, highlight it and click the **Delete** button.

To add a new rule set, click the **Add** button. The **Configure Rule Set Details** menu appears.



Figure 3-146. Add New Rule Set menu

First, enter a name for the new rule set and click the **Add** button.

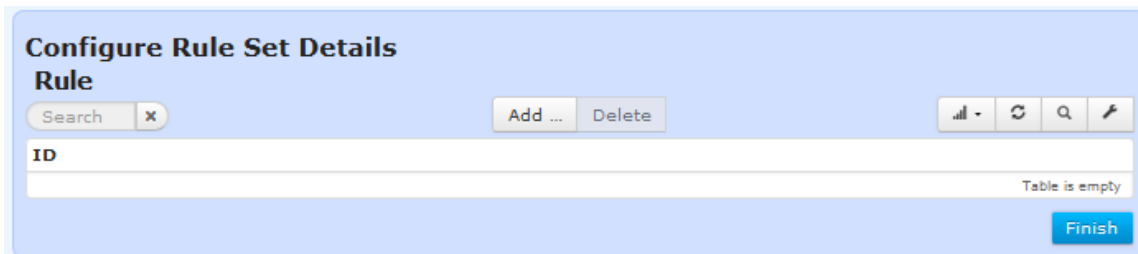


Figure 3-147. Rule Set Display



The menu that appears lists all rules contained within the new rule set. Since this is a new rule set, there are currently none. Click the **Add** button to add a rule. The **Configure Rule Details** menu appears.

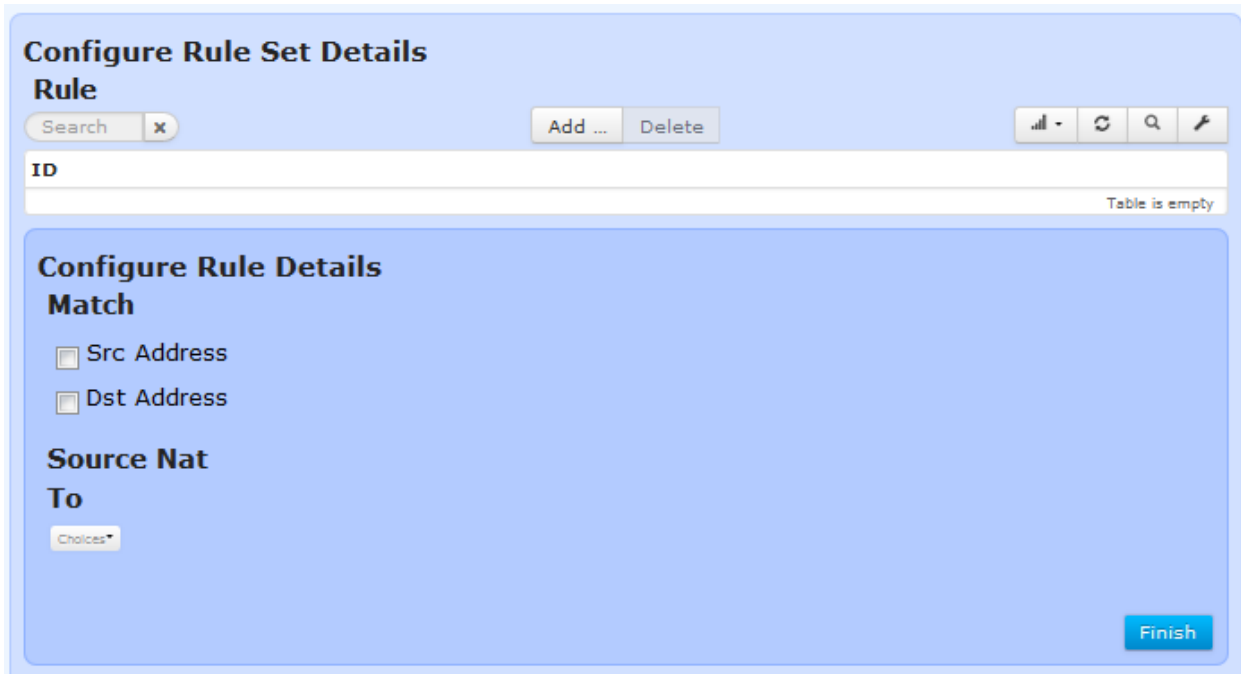


The image shows a light blue dialog box titled "Configure Rule Details". It contains a label "ID\*" followed by a text input field containing the number "1". In the bottom right corner, there are two buttons: "Add" (highlighted with a dashed border) and "Cancel".

**Figure 3-148. Add New Rule menu**

Enter a numeric ID for the rule and click the **Add** button. It is important to remember that rules are applied in ascending order. This means that a rule with ID 2, for example, would be processed after a rule of ID 1. Therefore, if the rules in a rule set should be applied in a particular order, care must be taken to set the IDs accordingly. In this example, only one rule is required.

Clicking the **Add** button leads to additional items to configure for new rule.



The image shows a "Configure Rule Set Details" screen. At the top, it says "Rule" and has a search bar with "x" and buttons for "Add ..." and "Delete". Below this is a table with one header "ID" and a message "Table is empty". The main area is titled "Configure Rule Details" and has sections for "Match" (with checkboxes for "Src Address" and "Dst Address") and "Source Nat" (with a "To" label and a "Choices\*" dropdown). A "Finish" button is in the bottom right.

**Figure 3-149. Rule menu**

The following main sections can be accessed from this screen:

- **Match** – Edit this section if the rule should be applied to a particular source or destination address.
- **Source NAT** – Edit this section if the rule should be applied to a specific interface or address.

Since the rule in this example applies to the cellular interface, configuration will be done on the **Source NAT** section.





Figure 3-150. Source NAT Submenu

Click the **Choices** dropdown. The following options are available:

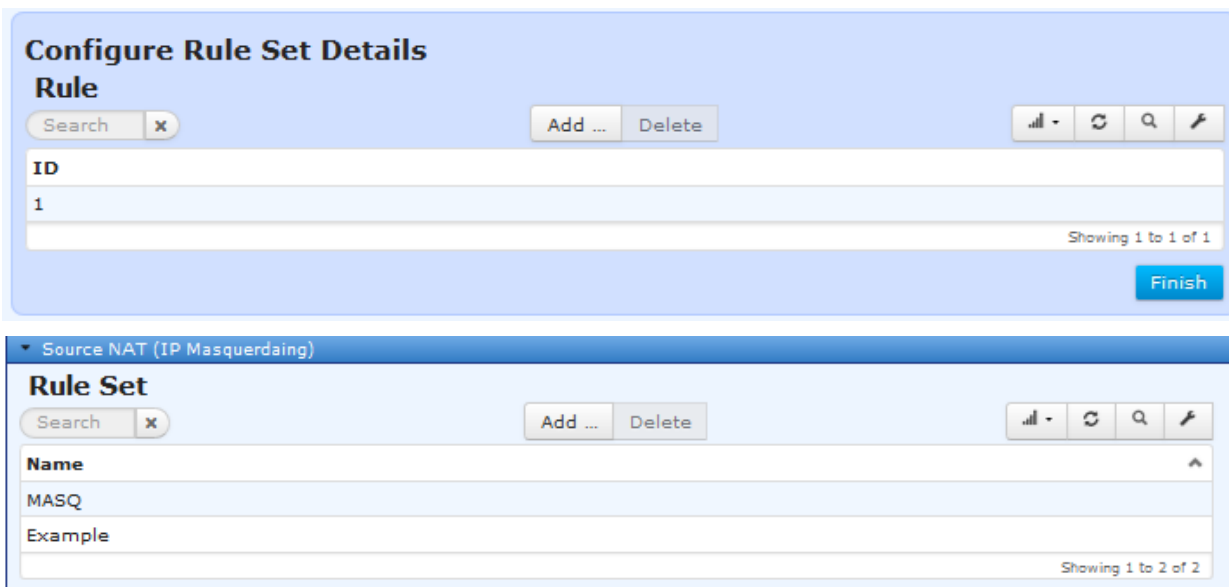
- **Interface** - Translate the source address to the address of the interface to which this rule-set has been applied.
- **Address** - Translate the source address to the specified address.

For this example rule, select **Interface**.



Figure 3-151. Source Creation

Click the check box from the left of **Interface** to apply this specifier to the rule. Once finished, click the **Save** button in the upper left corner of the screen. The finished Rule will then populate the table.



Now, the rule set must be applied to the desired interface. Navigate to **Interfaces** and click on **Cell** to proceed to the cell interface's menu. From there, navigate to **Basic Config / NAT**.



## Cell Interface ↻

Status Basic Config Advanced Config Actions

- General
- Cellular
- IPv4
- Filter
- Nat

### Nat

Source

Destination

Static

QoS

**Figure 3-152. Interface's NAT Configuration**

The **Source** dropdown box lists all available source NAT rule lists. Select the new rule list, and click the **Save** button in the upper left corner of the screen to apply it to the cellular interface.

### Using the CLI

To perform the same procedure with the CLI, first change to configuration mode. The steps needed to produce the same source NAT rule set and apply it to the cell interface follow.

1. Enable the firewall service, if it is not already enabled.  
**% set services firewall enabled true**
2. Create source NAT rule-set named “Example.”  
**% set services firewall nat source rule-set Example**
3. Create a rule for masquerading.  
**% set services firewall nat source rule-set Example rule 1 source-nat interface**
4. Apply this source NAT rule-set to the cellular interface.  
**% set interfaces Cell nat source Example**
5. Commit configuration and exit configuration mode.  
**% commit**

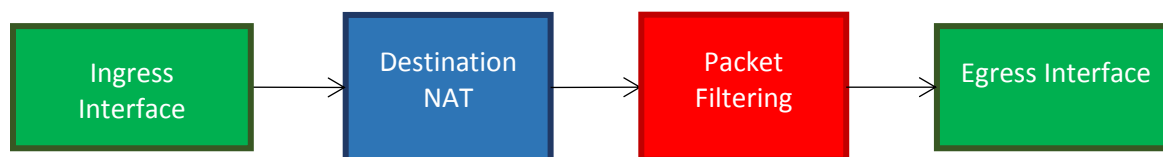
### Monitoring

At this time there are no commands to monitor traffic statistics for packets being masqueraded by the firewall. This feature may be added in future revisions of firmware.

### 3.8.10 Destination NAT (Port Forwarding)

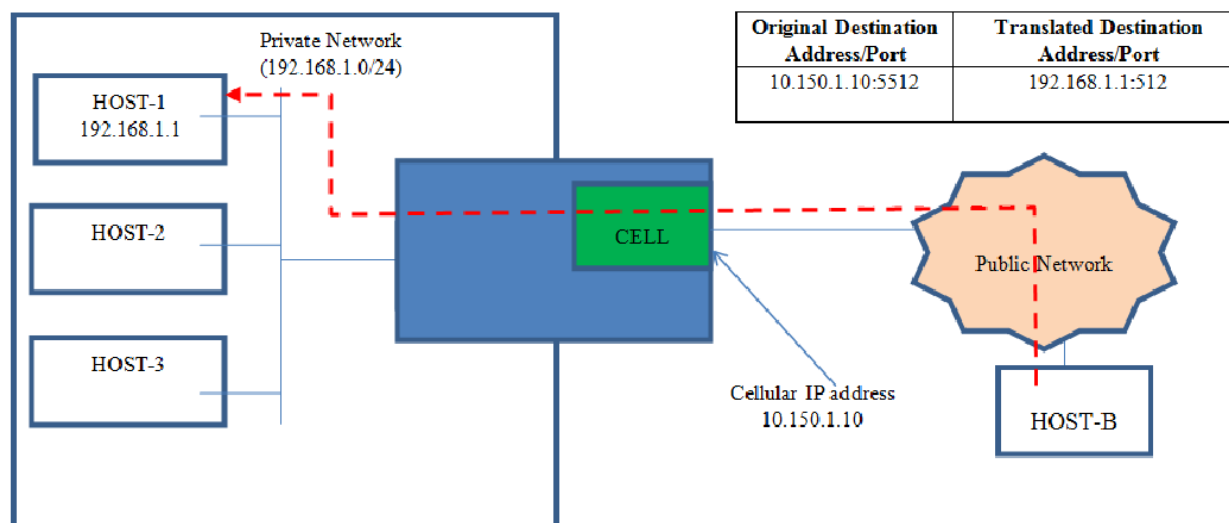
Destination NAT performs translation of destination IP address (and, optionally, destination port) of the traffic ingressing an interface. This is typically used to allow a host on the public network (HOST-B) to access a service running on a host in the private network (HOST-1). This is also called port forwarding.

Figure 3-153 shows the flow of packets being port-forwarded (DNAT'ed) through the MCR unit. For example, TCP traffic arriving at the cellular interface and getting port forwarded to a private host connected to the local Ethernet interface.



**Figure 3-153. Packets Being Port-Forwarded Through MCR**

In the figure below, HOST-B, located in the public network, sends MODBUS traffic on TCP port 5512 to 10.150.1.10. This traffic ingresses the MCR's cellular interface and must reach the MODBUS server on the private network, HOST-1, at 192.168.1.1:512. A destination NAT rule set must be applied to the cellular interface so that MODBUS traffic sent by HOST-B to 10.150.1.10:5512 is forwarded to 192.168.1.1:512



**Figure 3-154. Destination NAT Translation of IP Address**

## Configuring

Destination NAT configuration on MCR involves following high level steps:

1. Create a destination NAT rule-set.
2. Add one or more rules to perform destination NAT for specific incoming traffic on the public interface.
3. Apply the destination NAT rule-set to the public interface.

The following example describes the step-by-step configuration of an example destination NAT rule-set to perform port forwarding for example shown in Figure 3-154above.

## Using the Destination NAT Wizard

### Example

The Destination NAT Wizard is the simplest way to add a destination NAT rule-set. First, navigate to **Wizards** and click **Destination NAT/Port Forwarding** from either the navigation bar or the main Wizards page.



## Configuration Wizards

**Initial Setup Wizard**  
1 Initial Setup

**Services**  
1 VPN Setup

**Networking**

- 1 Basic Interface Setup  
To help configure basic IP and connectivity settings.
- 1 Access Control List (Filter)  
To help configure filters on one or more interfaces
- 1 Destination NAT (Port Forwarding)  
To help configure port forwarding on one or more interfaces
- 1 Source NAT (Masquerading)  
To help configure source NAT (Masquerading) on one or more interfaces.
- 1 Static NAT (one-to-one NAT)  
To help configure static NAT (one-to-one NAT) on one or more interfaces

Figure 3-155. Configuration Wizards menu

### Destination NAT (Port Forwarding)

MDS Orbit Firewall/NAT Configuration Wizard

This wizard provides set-up support for:  
1. Destination NAT (Port Forwarding)

A summary of all the changes will be provided at the end.

Cancel Back Next

Figure 3-156. Port Forwarding Wizard Introductory Page

The wizard's introduction page appears. Click **Next** to continue.

### Destination NAT (Port Forwarding)

Please select the Destination NAT rule-set that you would like to configure or click 'Add' to create a new one.

<input checked="" type="checkbox"/>	Name	Description

Delete Selected Edit Selected Add

Cancel Back Next

Click **Add** to create a new rule-set and enter name for the new rule set. Spaces are not allowed; use the underscore character instead. Click **OK** to continue.

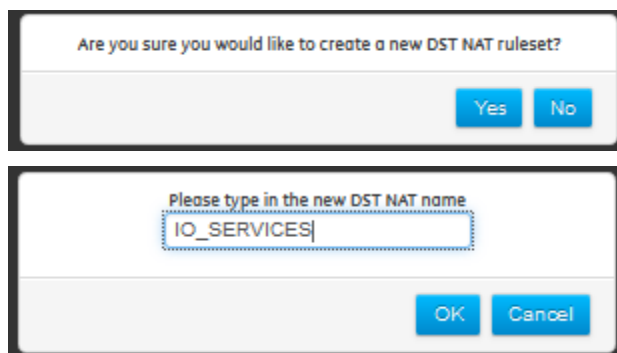


Figure 3-157. Entering a new destination NAT rule set name

### Destination NAT (Port Forwarding)

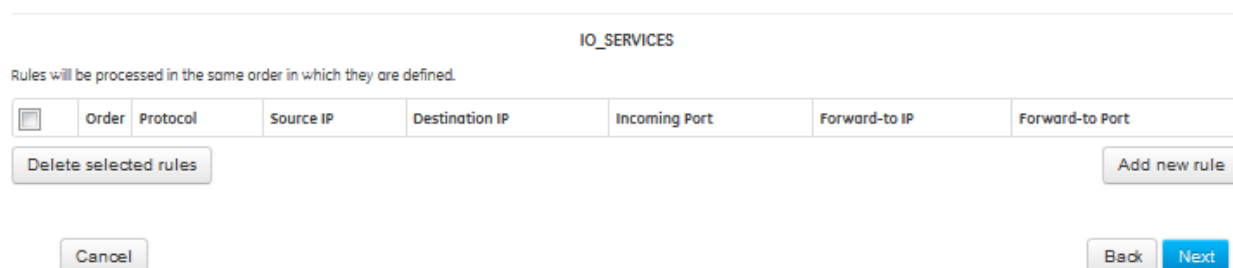


Figure 3-158. Destination NAT rules list for the new rule-set

The **Destination NAT** screen lists all rules contained within the new rule set. Since this is a new rule set, there are currently none. Click **Add New Rule** to add one. The rule creation menu appears.

### Destination NAT (Port Forwarding)

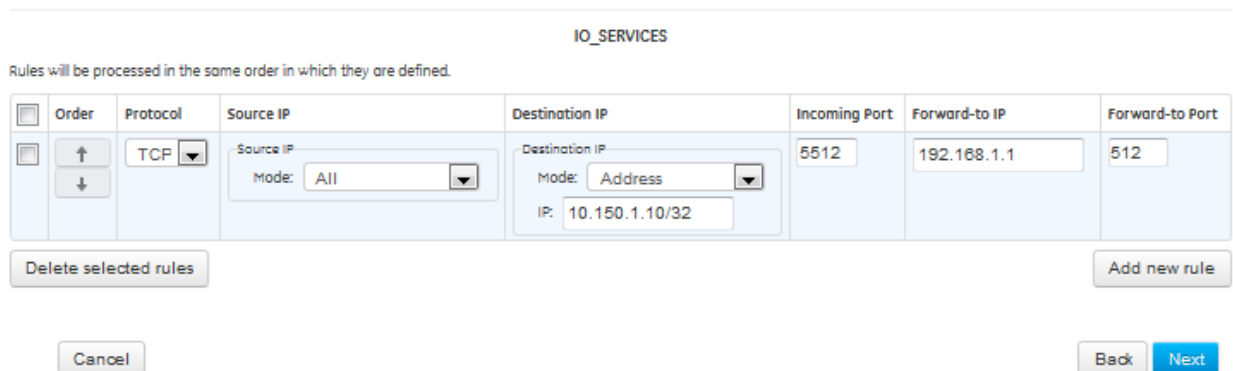


Figure 3-159. Creating a new destination NAT rule

The following options are available within the rule creation menu.

- **Order** – Click the arrows to sort rules in order of priority. Rules with higher priority are applied before rules with lower priority; rule sets containing more than one rule should be sorted accordingly.
- **Protocol** – *Options: All, SCTP, TCP, UDP, ICMP, ESP.* Specifies the IP protocol of incoming traffic that the rule should be applied to. (In the example above, this is *TCP*.)
- **Source IP** – Apply rule to traffic that originates at a specific address or addresses.
  - **Mode** – Options:



- All – Apply rule regardless of source address. (The example above uses this configuration.)
  - Address - Apply rule to a specific source address and prefix.
  - Address Range – Apply rule to a range of source addresses.
  - Address Set – Apply rule to a non-contiguous set of source addresses.
  - Not Address - Apply rule to traffic that does *not* originate from a specific address and prefix.
  - Not Address Range – Apply rule to traffic that does *not* originate from a specific source address range.
  - Not Address Set – Apply rule to traffic that does *not* originate from a non-contiguous set of source addresses.
- **Destination IP** – Apply rule to traffic that ingresses the unit at a specific address or addresses.
    - **Mode** – Options:
      - All – Apply rule regardless of destination address.
      - Address - Apply rule to a specific destination address and prefix.(In the example above, this is *10.150.1.1/32*.)
      - Address Range – Apply rule to a range of destination addresses.
      - Address Set – Apply rule to a non-contiguous set of destination addresses.
      - Not Address - Apply rule to traffic that does *not* ingress at a specific address and prefix.
      - Not Address Range – Apply rule to traffic that does *not* ingress at a specific destination address range.
      - Not Address Set – Apply rule to traffic that does *not* ingress at a non-contiguous set of destination addresses.
  - **Incoming Port** – Apply rule to a pre-translated ingress port. In the example above, this is *5512*.
  - **Forward to IP** – The IP address to which traffic matching this rule should be forwarded. In the example above, this is *192.168.1.1*.
  - **Forward to Port** – The port to which traffic matching this rule should be forwarded. In the example above, this is *512*.

The example above can be configured with a single rule. Once all selections are complete, click **Next** to continue.

**Destination NAT (Port Forwarding)**

Apply destination NAT rule-sets to incoming traffic on the interface(s).

Name	Type	Port Forwarding Rule-Set
Bridge	bridge	<input type="text"/>
Cell	cellular	<input type="text" value="IO SERVICES"/>
ETH2	ethernet	<input type="text"/>
Wi-Fi	wifi	<input type="text"/>

**Figure 3-160. Interface Selection menu**

The Interface Selection menu allows the created rule set to be applied to one or more interfaces. To do so, click the dropdown box next to the desired interface and select the rule set name. In the example above, the new rule set should be applied to the cellular interface. Click **Next** to continue.



## Destination NAT (Port Forwarding)

### Summary

Keypath	Change Type	Old Value	New Value
nat/destination/rule-set{IO_SERVICES}/rule(1)/match/protocol	value_set		tcp
nat/destination/rule-set{IO_SERVICES}/rule(1)/match/dst-address/address	value_set		10.150.1.10/32
nat/destination/rule-set{IO_SERVICES}/rule(1)/match/dst-address	created		
nat/destination/rule-set{IO_SERVICES}/rule(1)/match/dst-port	value_set		5512
nat/destination/rule-set{IO_SERVICES}/rule(1)/destination-nat/address	value_set		192.168.1.1
nat/destination/rule-set{IO_SERVICES}/rule(1)/destination-nat/port	value_set		512
nat/destination/rule-set{IO_SERVICES}/rule(1)	created		
nat/destination/rule-set{IO_SERVICES}	created		
/ifinterfaces/interface{Cell}/nat/destination	value_set		IO_SERVICES

Cancel

Back **Submit**

**Figure 3-161. Destination NAT rule summary page**

A summary page appears that displays the items in the configuration's data model that were changed, and type of changes that occurred. To save and apply the changes, click **Submit**.

## Using the Web UI

To view the list of destination NAT rule sets that exist on the device at any time, navigate to **Firewall ---> Basic Config / Destination NAT**

**Firewall Service**

Status Basic Config **Advanced Config** Actions

General  
Address Set  
Filter (Access Control List)  
Destination NAT (Port forwarding)

**Rule Set**

Search  Add ... Delete

**Name**

IO\_SERVICES

Showing 1 to 1 of 1

**Configure Rule Set Details**

**Rule**

Search  Add ... Delete

ID	Match - Protocol	Match - Dst Port	Destination Nat - Address	Destination Nat - Port
1	tcp	5512	192.168.1.1	512

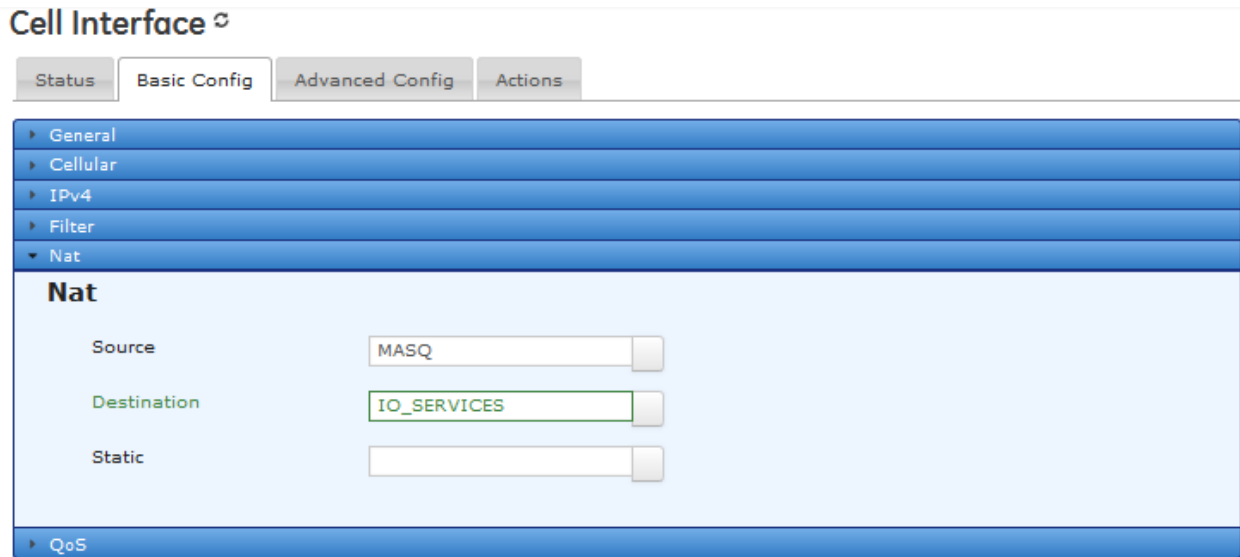
Showing 1 to 1 of 1

**Finish**

**Figure 3-162. List of destination NAT rule sets**



An existing rule set may be applied, or removed from a rule set by navigating to *Interfaces*. Click the interface name and view the *Basic Config / NAT* menu.



**Figure 3-163. The cellular interface's NAT menu**

To add or change a Destination NAT rule set, click the button next to **Destination NAT**, select the desired rule set and click **OK**. Finally, click the **Save** button in the upper left corner of the screen to save the changes.

## Using the CLI

To perform the same procedure with the CLI, first change to configuration mode. The steps needed to produce the same destination NAT rule set and apply it to the cell interface follow.

1. Enable the firewall service, if it is not already enabled.  
`% set services firewall enabled true`
2. Create a source NAT rule-set named IO\_SERVICES.  
`% set services firewall nat destination rule-set IO_SERVICES`
3. Create a rule to port forward Modbus TCP traffic that enters the cellular interface on port 5512 to port 512 on the private HOST-1.  
`% set services firewall nat destination rule-set IO_SERVICES rule 1 match protocol tcp`  
`% set services firewall nat destination rule-set IO_SERVICES rule 1 match dst-address address 10.150.1.10/32`  
`% set services firewall nat destination rule-set IO_SERVICES rule 1 match dst-port 5512`  
`% set services firewall nat destination rule-set IO_SERVICES rule 1 destination-nat address 192.168.1.1`  
`% set services firewall nat destination rule-set IO_SERVICES rule 1 destination-nat port 512`
4. Apply this destination NAT rule-set to the cellular interface.  
`% set interfaces Cell nat destination IO_SERVICES`
5. Commit the configuration and exit configuration mode.  
`% commit`

## Monitoring

At this time there are no commands to monitor traffic statistics for packets masqueraded by the firewall. This feature may be added in future revisions of firmware.





### 3.8.11 Static NAT

#### Understanding

Static NAT performs translation of a single public (external network) IP address, or entire subnet, to a private (internal network) IP address or subnet. This can be used to make a private host on an internal network accessible to hosts on the public/external network. This can also be used connect two networks with overlapping address ranges. In particular, this is useful when connecting multiple remote sites with same local addressing (e.g. 192.168.1.0/24) to the back-office network (e.g. 172.16.10/24) using IPsec VPN.

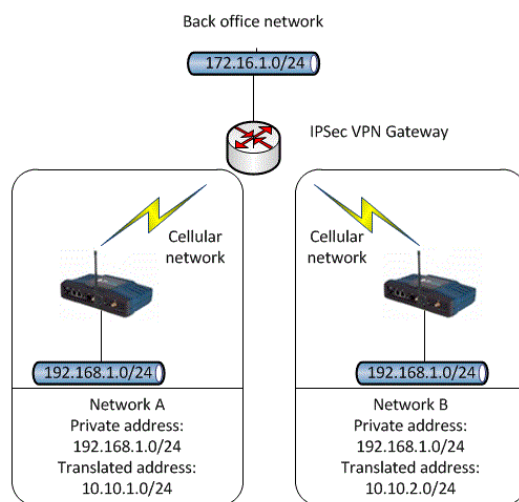


Figure 3-164. Static NAT Example

The figure above shows a network that uses static NAT to prevent routing issues. Two internal subnets maintain IPsec connections over their respective MCRs' cellular network connection to a VPN gateway on a back-office network (172.16.1.0/24). Both subnets, which are located in separate sites, have the same IP address schemes (192.168.1.0/24). Two networks with the same IP addresses would result in routing issues, so each MCR is configured with static NAT so that the local internal subnet (192.168.1.0/24) translates to a different external IP address block (local tunnel subnet) for site A and B.

#### Back office IPsec Configuration

##### Site-A IPsec Connection:

Local Tunnel Network = 172.16.1.0/24  
Remote Tunnel Network = 10.10.1.0/24

##### Site-B IPsec Connection:

Local Tunnel Network = 172.16.1.0/24  
Remote Tunnel Network = 10.10.2.0/24

##### Site-A IPsec Configuration:

Local Tunnel Network = 10.10.1.0/24  
Remote Tunnel Network = 172.16.1.0/24  
Static NAT: 10.10.1.0/24 -> 192.168.1.0/24

##### Site-B IPsec Configuration:

Local Network = 10.10.2.0/24  
Remote Network = 172.16.1.0/24  
Static NAT: 10.10.2.0/24 (local tunnel network is the external network) -> 192.168.1.0/24 (internal network)



Using the above configuration, a host in back office network shall use 10.10.1.2 external address to access an internal host 192.168.1.2 in site A and use 10.10.2.2 external address to access an internal host 192.168.1.2 in site B.

## Configuration

Static NAT configuration on MCR involves following high level steps:

1. Create a static NAT rule-set.
2. Add rule to perform static NAT on the public interface or IPsec connection.

## Example

### Using the Static NAT Wizard

The following example demonstrates step-by-step static NAT configuration for Network A shown in Figure 3-164.

During this example, assume the following:

1. An IPsec connection named **Network\_A\_IPsec\_Connection** is already created and configured on the Orbit MCR in Network A. Refer to Section 3.8.12VPN for more information on creating an IPsec connection.
2. Network B has already been appropriately configured for static NAT. Only Network A's configuration will be shown in this example.

The **Static NAT Wizard** is the simplest way to configure static NAT on the unit. First navigate to **Wizards** and click on **One-to-One NAT** from either the navigation bar or the main Wizards page.

## Configuration Wizards

The screenshot displays the 'Configuration Wizards' interface. It is organized into three main sections:

- Initial Setup Wizard**: Contains one step, 'Initial Setup'.
- Services**: Contains one step, 'VPN Setup'.
- Networking**: Contains five steps:
  - Basic Interface Setup**: To help configure basic IP and connectivity settings.
  - Access Control List (Filter)**: To help configure filters on one or more interfaces.
  - Destination NAT (Port Forwarding)**: To help configure port forwarding on one or more interfaces.
  - Source NAT (Masquerading)**: To help configure source NAT (Masquerading) on one or more interfaces.
  - Static NAT (one-to-one NAT)**: To help configure static NAT (one-to-one NAT) on one or more interfaces.



## Static (One-to-one) NAT

### MDS Orbit Firewall/NAT Configuration Wizard

This wizard provides set-up support for:  
1. Static NAT (one-to-one NAT)

A summary of all the changes will be provided at the end.

Cancel

Back Next

Click **Next** to continue. Click on the **Add** button. Confirm to create a new rule and then enter a name for the static NAT rule list. Click **Ok** to continue.

Are you sure you would like to create a new Static NAT ruleset?

Yes No

Please type in the new Static NAT name

Static\_NAT\_Network\_A

OK Cancel

The next menu shows all rules contained within the newly named rule set. You may edit existing rules, delete them, or add new ones. Since the rule set is new, it contains no rules at first. Click **Add New Rule** to add one. The rule creation menu appears.

## Static (One-to-one) NAT

Static\_NAT\_Network\_A

Rules will be processed in the same order in which they are defined.

<input type="checkbox"/>	Order	Match	Static NAT
<input type="checkbox"/>	↑ ↓	External Address: 10.10.1.0/24	Internal Address: 192.168.1.0/24

Delete selected rules Add new rule

**Figure 3-165 Adding a static NAT rule with the Static NAT Wizard**

The following options are available within the rule creation menu.

- **Order** – Click the arrows to sort rules in order of priority. Rules with higher priority are applied before rules with lower priority; rule sets containing more than one rule should be sorted accordingly.
- **External Address** - The external address is the address that is translated to an internal address. (This is the rule{1}/match/dst-address in the CLI).
- **Internal Address** - The internal address is the address that is translated to the external address. This is the rule{1}/static-nat/address in the CLI).

In Network A above, this is 192.168.1.0/24.

Once the rule is complete, click **Next** to continue. The **Interface Selection** screen appears.



## Static (One-to-one) NAT

Apply static NAT rule-sets to incoming and outgoing traffic on the interface(s) and IPsec connections.

Name	Type	Port Forwarding Rule-Set
Bridge	bridge	<input type="text"/>
Cell	cellular	Static NAT Network A
ETH2	ethernet	<input type="text"/>
Wi-Fi	wifi	<input type="text"/>

Cancel

Back

Next

The **Interface Selection** menu allows you to apply a static NAT rule list to an interface or IPsec connection on the MCR. Select the name of the static NAT rule list from the dropdown box to the right of the interface or IPsec connection and click **Next** to continue.

## Static (One-to-one) NAT

### Summary

Keypath	Change Type	Old Value	New Value
nat/static/rule-set[Static_NAT_Network_A]/rule(1)/match/dst-address	value_set		10.10.1.0/24
nat/static/rule-set[Static_NAT_Network_A]/rule(1)/static-nat/address	value_set		192.168.1.0/24
nat/static/rule-set[Static_NAT_Network_A]/rule(1)	created		
nat/static/rule-set[Static_NAT_Network_A]	created		
/if:interfaces/interface(Cell)/nat/static	value_set		Static_NAT_Network_A

Cancel

Back

Submit

A summary page appears that displays the items in the configuration's data model that were changed, and type of changes that occurred. To save and apply the changes, click **Submit**.

To view the list of destination NAT rule sets that exist on the device at any time, navigate to **Firewall ---> Basic Config / Static NAT**.

## Firewall Service

Status

Basic Config

Advanced Config

Actions

- ▶ General
- ▶ Address Set
- ▶ Filter (Access Control List)
- ▶ Destination NAT (Port forwarding)
- ▶ Source NAT (IP Masquerading)
- ▼ Static NAT (One-to-One NAT)

### Rule Set

Search  Add ... Delete

**Name**

Static\_NAT\_Network\_A

Showing 1 to 1 of 1



## Using the CLI

To perform the same procedure with the CLI, first change to configuration mode. The steps needed to produce the same destination NAT rule set and apply it to the cell interface follow.

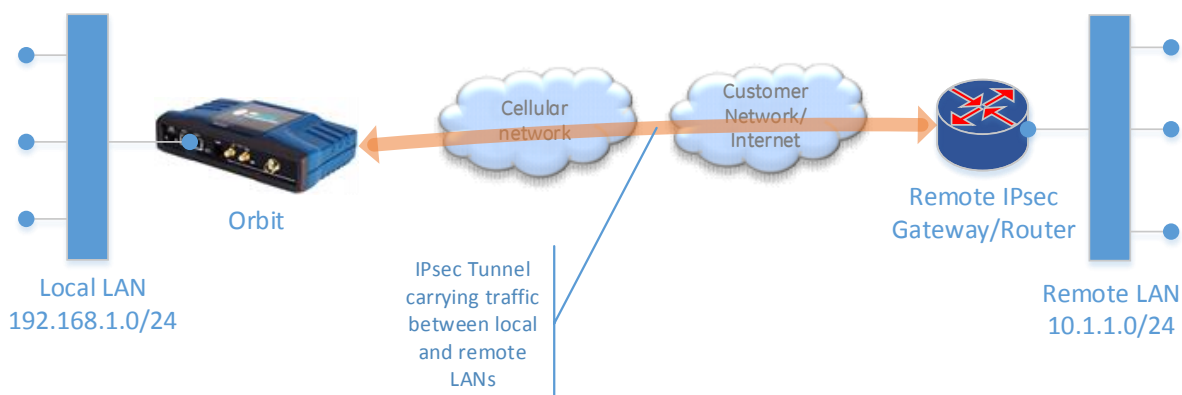
1. Enable firewall service, if it is not already enabled.  
`% set services firewall enabled true`
2. Create a static NAT rule set. The rule set name used below is Static\_NAT\_Network\_A.  
`% set services firewall nat static rule-set Static_NAT_Network_A`
3. Create rule for translating the original “static-nat address” to the translated “match dst-address.”  
`% set services firewall nat static rule-set Static_NAT_Network_A rule 1 match dst-address 10.10.1.0/24`  
`% set services firewall nat static rule-set Static_NAT_Network_A rule 1 static-nat address 192.168.1.0/24`
4. To apply the rule-set to an existing IPsec connection (here named IPSEC\_CONN), use the following command.  
`% set services vpn ipsec connection IPSEC_CONN nat static Static_NAT_Network_A`
5. Commit configuration and exit configuration mode.  
`% commit`

### 3.8.12 VPN

#### Understanding

Orbit supports following types of Virtual Private Network (VPN) setups:

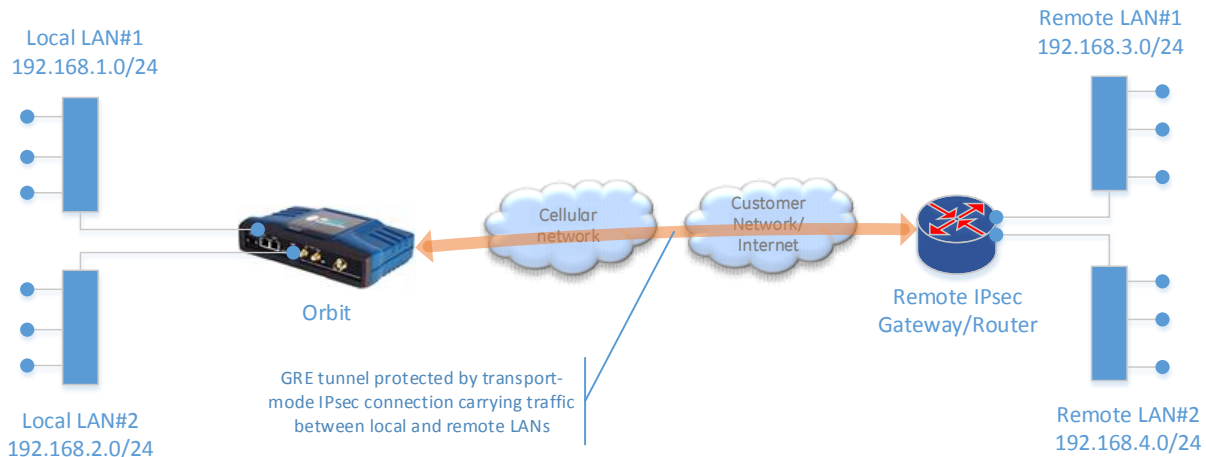
1. **Site-to-Site Policy-Based IPsec L3VPN** – This enables routing of traffic to/from single local LAN of Orbit from/to single remote LAN on the other side of the Remote IPsec router through an IPsec tunnel. Only unicast IP traffic matching the local and remote subnets can be sent over this tunnel. If more than a single pair of local or remote subnets need to exchange data then each pair requires its own tunnel. This is called a policy based VPN since the traffic selector/policy i.e. the local and remote IP subnets is included in the IPsec configuration.



In this setup, there is single LAN behind Orbit and traffic from this LAN needs to be routed towards a single remote LAN on the other side of the remote router through an IPsec tunnel. If the remote LAN is configured as 0.0.0.0/0, then Orbit will route traffic from local LAN to **any** other destination through this tunnel.

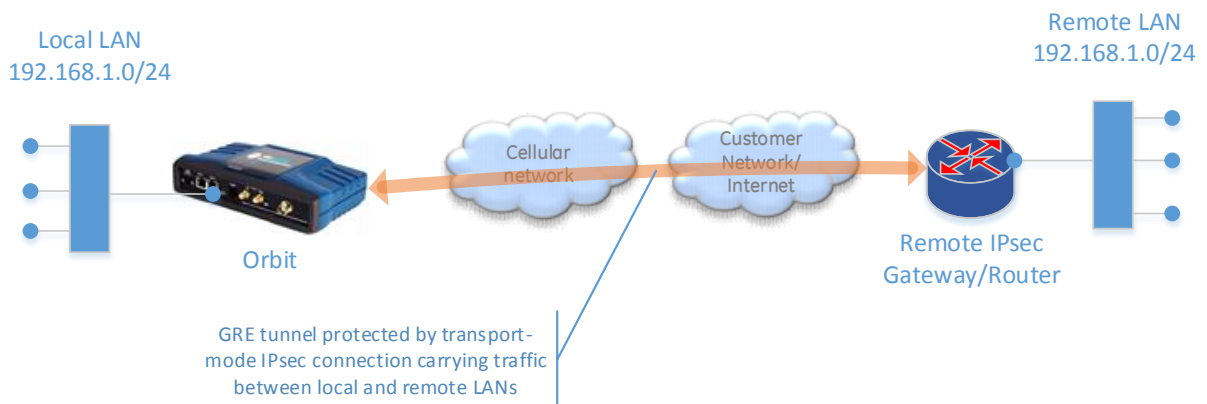


2. **Site-to-Site GRE/IPsec L3VPN** – This enables **routing** of traffic to/from one or more local LANs of Orbit from/to one or more remote LANs on the other side of the Remote IPsec router through a single GRE tunnel protected by transport mode IPsec connection.



In this setup, there are one or more LANs behind Orbit and traffic from these LANs needs to be **routed** towards a one or more remote LANs on the other side of the remote router through a GRE tunnel protected by IPsec transport mode connection. The routes are added for remote LAN networks on Orbit either statically (via manual configuration) or dynamically (by running routing protocols like RIP/OSPF/BGP over GRE tunnel).

3. **Site-to-Site GRE/IPsec L2VPN** – This enables **bridging** of traffic to/from one or more local LANs of Orbit from/to one or more remote LANs on the other side of the Remote IPsec router through a single GRE tunnel protected by transport mode IPsec connection. Orbit also supports VLAN trunking over GRE tunnel for a case where there is more than one LAN behind Orbit and remote router.



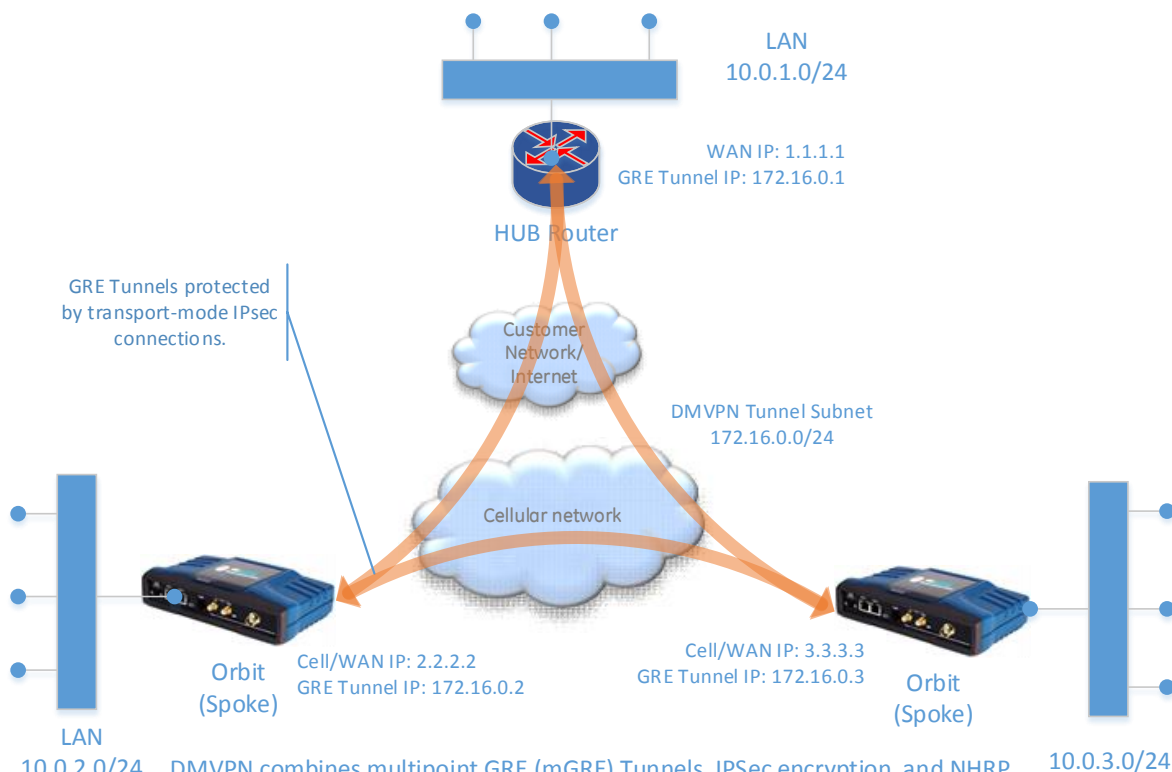
In this setup, there is single LAN behind Orbit and traffic from this LAN needs to be **bridged** with single remote LAN on the other side of the remote router through a GRE tunnel protected by IPsec transport mode connection. In this mode, the GRE tunnel is in Ethernet-over-GRE mode and simulates a point-to-point layer-2 VPN enabling MAC visibility and learning between the two sites. Orbit also supports VLAN trunking over the GRE tunnel in a case there is more than one LAN behind Orbit and Remote router.

4. **Dynamic Multipoint/Mesh VPN (DMVPN)** - DMVPN combines multipoint GRE (mGRE) Tunnels, IPsec encryption and NHRP (Next Hop Resolution Protocol) functionality to enable easier configuration of hub-to-spoke VPN deployments. In addition, it enables formation of on-demand dynamic tunnels between spokes for a full or partial mesh VPN network. The routes are added for



remote LAN networks on Orbit either statically (via manual configuration) or dynamically (by running routing protocols like RIP/OSPF/BGP over multipoint GRE tunnel).

In a hub-n-spoke deployment, where there is one hub router in central office and large number of spoke router at remote sites, if site-to-site VPN setup is used then each spoke requires its own tunnel configuration on the hub router. This can make hub configuration unwieldy. Also, everytime a new spoke site is added to the deployment, the hub configuration needs to be updated. This can become cumbersome from management perspective. DMVPN uses single multipoint GRE tunnel interface on the hub which needs to be configured only once initially and is used to terminate all the spoke tunnels. Addition of new spoke site doesnot require update of hub configuration if dynamic routing protocols are used to add routes towards remote LANs at the spoke site. Although, DMVPN technology is based on open standards, it was created by Cisco and hence is primarily only supported by Cisco routers designed for use as IPsec hub routers.



DMVPN combines multipoint GRE (mGRE) Tunnels, IPsec encryption and NHRP (Next Hop Resolution Protocol) functionality to enable easier configuration of hub-to-spoke VPN deployments. In addition, it enables formation of on-demand dynamic tunnels between spokes for a full or partial mesh VPN network. The routes are added for remote LAN networks on Orbit either statically (via manual configuration) or dynamically (by running routing protocols like RIP/OSPF/BGP over multipoint GRE tunnel).

### IPsec Overview

IPsec, Internet Protocol Security, is a set of protocols defined by the IETF, Internet Engineering Task Force, to provide IP security at the network layer.

An IPsec based VPN is made up by two parts:

- Internet Key Exchange protocol (IKE)
- IPsec protocols (ESP, AH)



The first part, IKE, is the initial negotiation phase, where the Orbit device and VPN gateway agree on which methods will be used to provide security for the underlying IP traffic. There are two IKE protocol versions: IKE-v1 and IKE-v2. These are not compatible with each other. The IKE-v2 is more efficient and therefore should be preferred for new deployments. The MCR supports IKE-v1 and IKE-v2.

The other part is the actual IP data being transferred, using the encryption and authentication methods agreed upon in the IKE negotiation. This is accomplished by using IPsec protocols like Encapsulating Security Payload (ESP) or Authentication Header (AH). Orbit MCR only supports ESP protocol as it provides both encryption and authentication of the data. The AH protocol provides only data authentication.

The process of IPsec VPN connection establishment consists of following phases:

- IKE Phase-1 (IKE security negotiation)
  - IKE authenticates IPsec peers and negotiates IKE Security Association (SAs) during this phase, setting up a secure channel for negotiating IPsec SAs in phase 2
- IKE Phase-2 (IPsec Security Association)
  - IKE negotiates IPsec SA parameters and sets up matching IPsec SAs in the peers
- Data Transfer
  - Data is transferred between IPsec peers based on the IPsec parameters and keys stored in the SA database

Both the IKE and the IPsec connections have limited lifetimes. These lifetimes prevent a connection from being used too long, which is desirable from a cryptanalysis perspective.

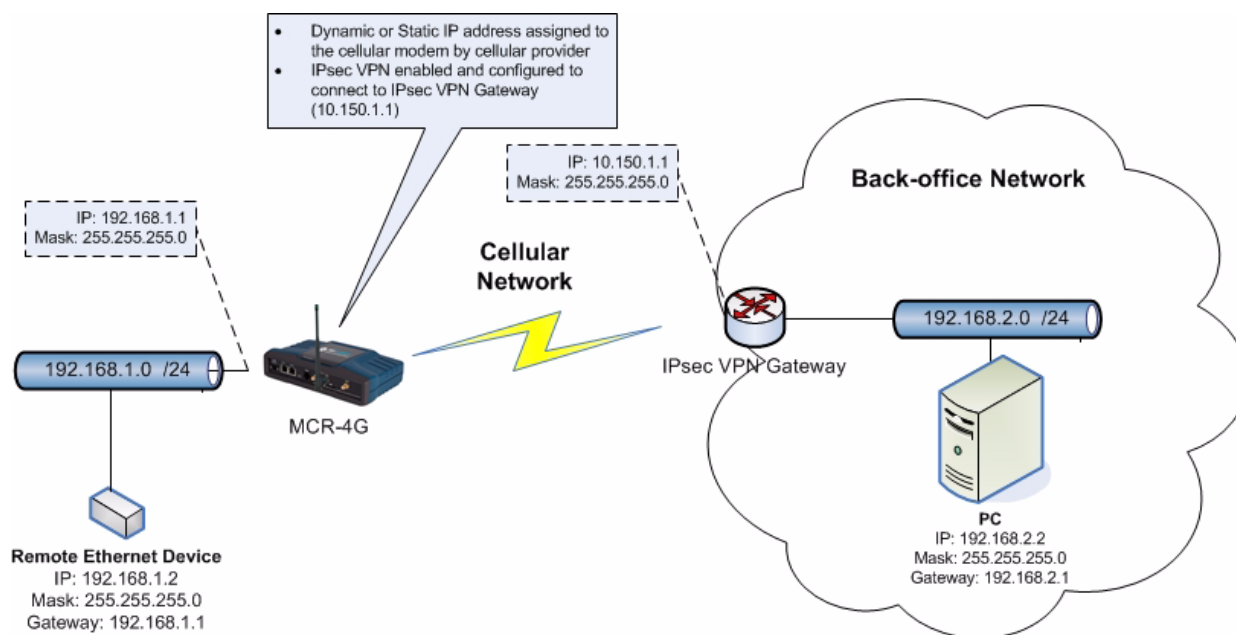
The IPsec lifetime is generally shorter than the IKE lifetime. This allows for the IPsec connection to be re-keyed simply by performing another phase-2 negotiation.

## Configuration

### Site-to-Site IPsec VPN Configuration

The Figure 3-166 below shows a site-to-site policy-based IPsec VPN setup to securely connect remote private network (LAN or WiFi) with the customer's backoffice/data center private network. This enables IP traffic from/to devices connected to either LAN, WiFi or Serial port of the Orbit to securely flow to/from back-office applications via a secure tunnel through a public cellular network. The tunneled application traffic is authenticated and encrypted to protect from eavesdropping, tampering and replay attacks.





**Figure 3-166. VPN Setup Example**

The remote Ethernet device is connected to the Orbit via Ethernet on 192.168.1.0/24 network. The device establishes a IPsec tunnel with IPsec VPN gateway, thereby securely connecting remote private network (192.168.1.0/24) with back-office private network (192.168.2.0/24). This allows PC (192.168.2.2) to communicate with remote Ethernet device (192.168.1.2) using any TCP/UDP/IP based protocol and vice versa.

Following are the high level configuration steps involved in IPsec configuration:

6. Configure an IKE policy specifying an authentication method, cipher suites to be included the proposal during IKE phase-1 and the credentials to be used for authentication, e.g.; certificates or pre-shared keys.
7. Configure an IKE peer specifying the peer endpoint address and IKE policy to be used for IKE phase-1 negotiation. The “role” specifies whether Orbit initiates the connection (initiator) or it waits for the connection from the peer (responder). This should usually be set to “initiator”.
8. Configure an IPsec policy specifying ESP cipher suites to be included in the proposal during IKE phase-2.
9. Configure an IPsec connection specifying IKE peer, IPsec policy and local and remote private IP subnets.

---

**NOTE** The above configuration parameters should match with the corresponding parameters set in the peer. Otherwise, the IPsec tunnel will not succeed. Typical configuration mistakes include incorrect security credentials (psk or certificates/keys), mismatched cipher suite configuration and mismatched local and remote subnet configuration.

---

## Example

The following example describes the step-by-step VPN configuration for the example network shown in figure above. We'll assume that certificates are being used as security credentials and have already been loaded in the Orbit either manually or via SCEP.

Configuration of the example above is possible via the Web UI's VPN Setup Wizard, or the CLI. Both procedures are shown below.

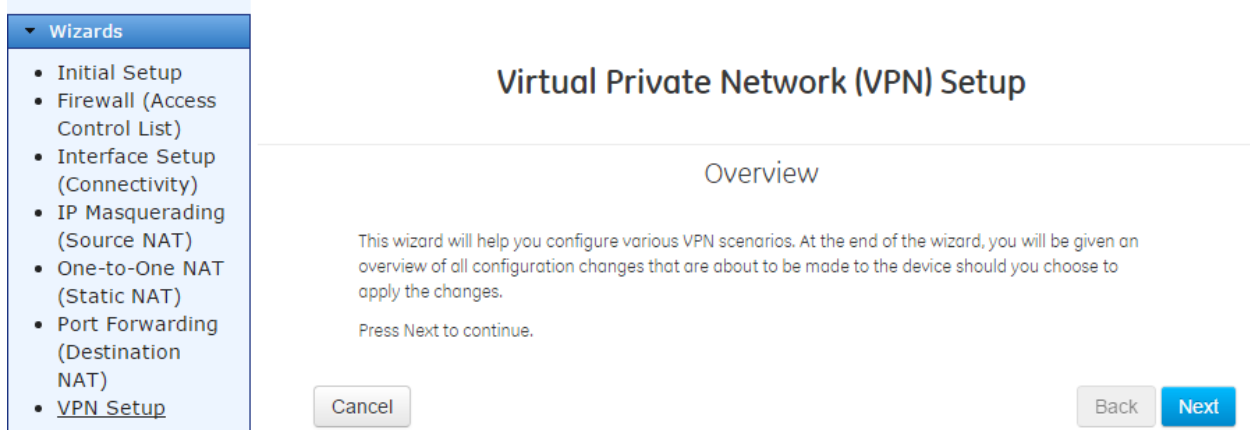


## Using the VPN Setup Wizard

If the VPN uses certificated-based authentication, then the certificates must be installed prior to running the VPN Setup Wizard. (See section 3.9.1 Certificate Management and 802.1X Authentication.) Furthermore, the date and time must be set correctly on the unit or authentication will fail (See section 3.7.1—Date, Time and NTP on Page 162).

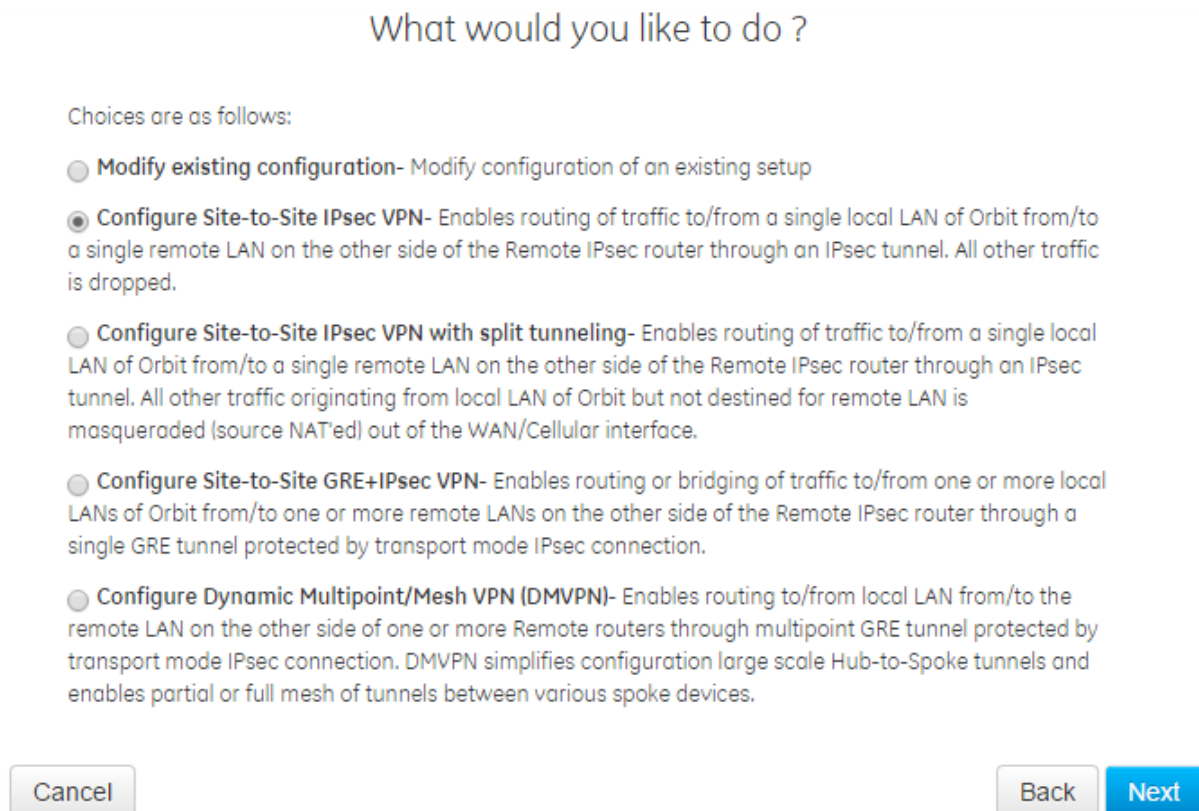
In this example, we assume that the pre-shared key based authentication is used.

The **VPN Setup Wizard** is the simplest way to configure a VPN connection on the unit. First navigate to **Wizards** and click on **VPN Setup** from the navigation side-bar.



**Figure 3-167. VPN Wizard Selection and Start Screen**

Click **Next** to continue. The next screen provides a list of VPN setups that one can choose from for a particular use case. For this example, we'll select "Configure Site-to-Site IPsec VPN".

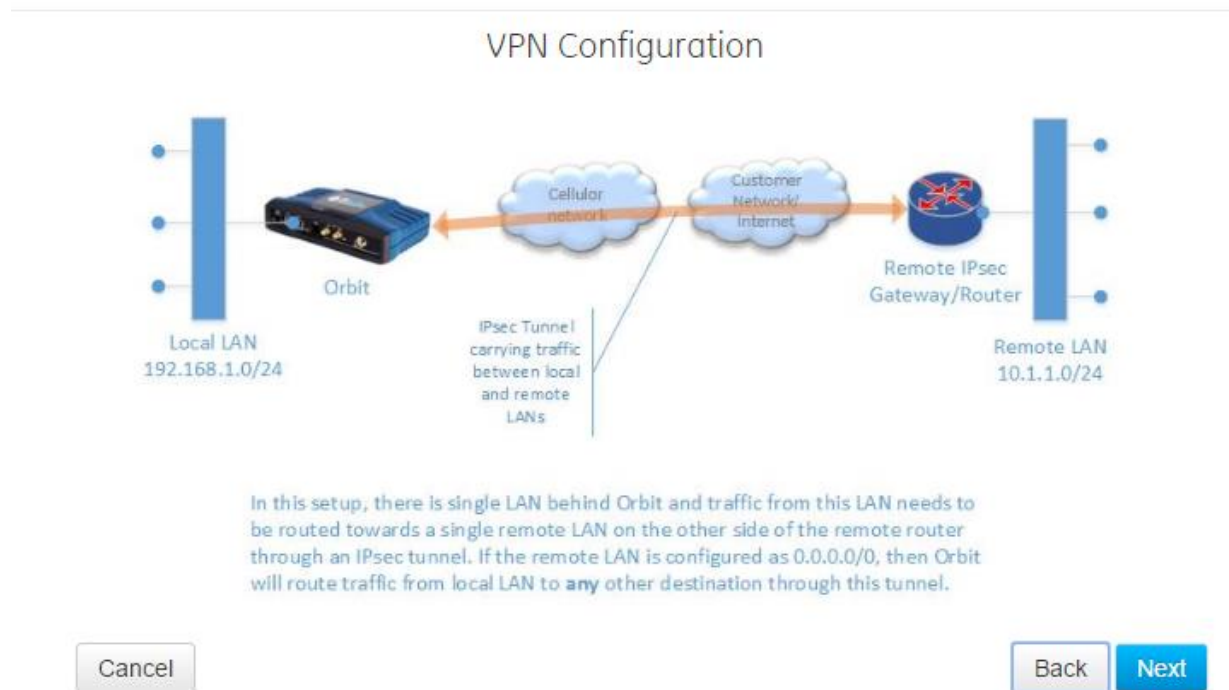




**Figure 3-168. VPN Setup Selection Screen**

Click **Next** to continue. The next screen shows an example network diagram for the selected setup.

## Virtual Private Network (VPN) Setup



**Figure 3-169. VPN Setup Network Diagram**

Click **Next** to continue. The next screen requires one to specify a name for this VPN connection.

## Virtual Private Network (VPN) Setup

VPN Configuration

Specify a name for this VPN connection

Cancel Back Next

**Figure 3-170. VPN – Specifying Name**



Click **Next** to continue. The next screen requires one to specify the IKE peer endpoint, local IKE identity and peer IKE identity.

## IPsec Configuration

Specify the IP address or DNS name of the peer.

Choices ▾

Address

Specify the local identity that the peer expects this device to use to identify itself during IKE negotiation.

For pre-shared key based authentication, this is typically the IP address or DNS name (FQDN). If the WAN/Cellular IP address is dynamic, then the DNS name (FQDN) should be specified. For certificate based authentication (pubkey), the Distinguished Name (DN) of the client certificate is implicitly used as the identity. In this case, set this field to default.

Choices ▾

Default

Specify the peer identity that this device expects the peer to use to identify itself during IKE negotiation.

For pre-shared key based authentication, this is typically the IP address or DNS name (FQDN) of the peer. If the WAN/Cellular IP address of the peer is dynamic, then the DNS name (FQDN) should be specified. For certificate based authentication (pubkey), the Distinguished Name (DN) of the peer's client certificate is implicitly used as the identity. In this case, set this field to default.

Choices ▾

Default

- **Local Endpoint** – *any (default), address, FQDN*. This is an optional setting and hence not available for configuration via the VPN wizard. This can be configured from *Services->VPN service->Basic Config* menu.
  - **Any** – Local address is chosen automatically during negotiation.
  - **Address** – Force local address for this connection to a specified IP address.
  - **FQDN** – Force local address for this connection to an IP address resolved by the specified fully qualified domain name (FQDN).
- **Local Identity** – *Default, address, FQDN, user-FQDN, DN*.
  - **Default** – Defaults to local IP address when using pre-shared key based authentication and to the DN of the local certificate when using certificated-based authentication.
  - **Address** – Use the specified IP address as the local IKE identity.
  - **FQDN** – Use the specified fully qualified domain name (FQDN) as the local IKE identity
  - **User-FQDN** – Use user-fully qualified domain name (user-FQDN) as the local IKE identity.
  - **DN** – Use the specified distinguished name as the local IKE identity.
- **Peer Endpoint** – *Address, FQDN*. Required setting.
  - **Address** – Specify the IP address of the IKE peer.



- **FQDN** – Specify the fully qualified domain name (FQDN) of the IKE peer.
- **Peer Identity** – *Default, address, FQDN, user-FQDN, DN.*
  - **Default** – Defaults to peer IP address when using pre-shared key based authentication and to the DN of the peer certificate when using certificated-based authentication.
  - **Address** – Use specified IP address as the IKE identity - required.
  - **FQDN** – Use specified fully qualified domain name (FQDN) as the peer IKE identity
  - **User-FQDN** – Use specified user-fully qualified domain name (user-FQDN) as the peer IKE identity.
  - **DN** – Use the specified distinguished name as the peer IKE identity.

Click **Next** to continue. The next screen requires you to specify the IKE version and authentication parameters.

## Virtual Private Network (VPN) Setup

### IPsec Configuration

Specify the IKE version.

Version

Specify the IKE authentication method.

**Auth Method \***

Specify the pre-shared-key to use for authentication.

**Pre Shared Key**

- **Version** – IKE, IKE v1, IKE v2.
  - **IKE** – If the Orbit is the initiator, it uses IKE v2. If the Orbit is the responder, it accepts either IKE v1 or IKE v2, according to the policy proposed by the initiator.
  - **IKE v1** – As an initiator or responder, the Orbit uses only IKE v1.
  - **IKE v2** – As an initiator or responder, the Orbit uses only IKE v2.
- **Auth Method** – *Public key, EAP-TTLS, Pre-shared key.*
  - **Public key** – Use RSA/ECDSA public key based authentication.

---

**NOTE:** The certificates must be installed on Orbit prior to VPN setup.

---

- **Pre-shared key** – In lieu of certificates, the EAP-TTLS uses a pre-shared key for authentication.
- **EAP-TTLS** – Use EAP-TTLS (Extensible Authentication Protocol Tunneled Transport Layer Security) based authentication. This is used for integrity and measurement (IMA) connections. See APPENDIX B – Integrity Measurement Authority (IMA).

The following options are available only when the authentication method chosen is **Public key** or **EAP-TTLS**. For more information on certificates, Certificate Management and 802.1X Authentication.

- **Cert Type** – *RSA, ECDSA.*



- **Cert ID** – Select the client certificate to be used in authentication. This dropdown shows all client certificates that have been installed on the Orbit. Certificates must be pre-installed prior to running the VPN Setup Wizard.
- **Key ID** – Select the private key to be used in authentication. This dropdown shows all private keys that exist on the Orbit. Keys must be pre-installed prior to running the VPN Setup Wizard.
- **CA Cert ID** – Select the Certificate Authority’s certificate to be used in authentication. This dropdown shows all CA certificates that exist on the Orbit. Certificates must be pre-installed prior to running the VPN Setup Wizard.

The following options are available only when the authentication method chosen is **Pre-shared key**.

- **Pre-shared Key** – The pre-shared key itself.

Click **Next** to continue. The next screen requires configuration of IKE phase-1 and IPsec (phase-2) ciphersuite (encryption algorithm, integrity (MAC) algorithm, DH group). Also, local IP subnet and remote IP subnet needs to be configured.

### IPsec Configuration

Specify the IKE (phase-1) encryption, integrity/MAC and key-group parameters. These should match the settings on the peer.

1 Encryption Algorithm	aes128-cbc
2 MAC Algorithm	sha256-hmac
3 DH Group	dh14

Specify the IPsec (phase-2) encryption, integrity/MAC and key-group parameters. These should match the settings on the peer.

1 Encryption Algorithm	aes128-cbc
2 MAC Algorithm	sha256-hmac
3 DH Group	dh14

Specify the local LAN network (e.g. 192.168.1.0/24).

1 Local IP Subnet	192.168.1.0/24
-------------------	----------------

Specify one or more remote LAN networks (e.g. 10.1.1.0/24).

Remote IP subnet	192.168.2.0/24
------------------	----------------

Cipher suites used for phase-1 and phase-2 must match corresponding configuration on the peer.

- **Encryption algorithm** – 3des, Aes 128 Cbc, Aes 192 Cbc, Aes 256 Cbc, Aes 128 Ctr, Aes 192 Ctr, Aes 256 Ctr, Aes 128 Ccm 8, Aes 192 Ccm 8, Aes 256 Ccm8, Aes 128 Ccm 12, Aes 192 Ccm 12, Aes 256 Ccm12, Aes 128 Ccm 16, Aes 192 Ccm 16, Aes 256 Ccm16, Aes 128 Gcm 8, Aes 192 Gcm 8, Aes 256 Gcm8, Aes 128 Gcm 12, Aes 192 Gcm 12, Aes 256 Gcm12, Aes 128 Gcm 16, Aes 192 Gcm 16, Aes 256 Gcm16.



**NOTE** Orbit supports 3DES (Triple Digital Encryption Standard), and 128-bit, 192-bit, and 256-bit AES (Advanced Encryption Standard) encryption. When using AES encryption, CBC (Cipher Block Chaining), CTR(Counter), CCM 8, CCM 12, and CCM 16 (Counter with CBC-MAC), and GCM 8, GCM 12, and GCM 16 (Galois/Counter Mode) modes of operation are available.

- **MAC algorithm** – *SHA-1 HMAC, SHA-256 HMAC, SHA-384 HMAC, SHA-512 HMAC.*  
Orbit supports HMAC (Hash-based Message Authentication Code), using either SHA-1(Secure Hash Algorithm), or 256-, 384-, or 512-bit SHA-2.
- **DH Group** – *DH-1, DH-2, DH-5, DH-14, DH-15*  
The DH Group setting determines the strength of the key in the Diffie-Hellman key exchange. Higher groups include more bits and are thus more secure, but require more time to complete the key exchange. For phase-2 ciphersuite configuration, DH group is optional. It needs to be configured only if perfect forward secrecy (PFS) is desired.

The local and remote subnets should also match those configured on the peer.

- **Local IP Subnet** – The local IP subnet behind Orbit.
- **Remote IP Subnet** – The remote IP subnet behind the peer IPsec VPN router.

Click **Next** to continue. The next screen requires one to select the interface over which this connection will be established. This is almost always the Cell interface.

Firewall Configuration

Specify the local WAN interface over which this VPN connection will be established.  
NOTE: The firewall filters applied to this interface will be automatically updated with rules to enable flow of VPN traffic. Select blank entry to prevent any firewall changes.

Interface

Click **Next** to continue. The next screen provides some general information.

Finish

This concludes the VPN setup wizard. On the following page you will see an overview of all changes made by this wizard. If after reviewing them you wish to make further changes, use the "Back" button to navigate back to the setting you would like to change. If you are satisfied with the changes, press the "Submit" button to commit your changes to the system.

**NOTE:** This wizard only enables creation of GRE interface for setups involving GRE in ip-over-gre mode. Please configure static routes or dynamic routing protocol over the GRE interface by going to "Routing" page

Press Next to continue.

Click **Next** to continue. The next screen lists all the changes that have been made by this wizard. Click **Submit** to commit these changes on Orbit.



### Configuration Summary

Key path	Change Type	Old value	New Value
/services/vpn/ike/policy{SRX240-1_t1_ike_policy}/auth-method	value_set		pre-shared-key
/services/vpn/ike/policy{SRX240-1_t1_ike_policy}/pre-shared-key	value_set		\$4\$E/r/Vg0IRrAPW9KcJTWQ0==
/services/vpn/ike/policy{SRX240-1_t1_ike_policy}/ciphersuite{CS1}	created		
/services/vpn/ike/policy{SRX240-1_t1_ike_policy}	created		
/services/vpn/ike/peer{SRX240-1_t1_ike_peer}/peer-endpoint/address	value_set		172.18.175.40
/services/vpn/ike/peer{SRX240-1_t1_ike_peer}/role	value_set		initiator
/services/vpn/ike/peer{SRX240-1_t1_ike_peer}/peer-identity/default	created		
/services/vpn/ike/peer{SRX240-1_t1_ike_peer}/ike-policy	value_set		SRX240-1_t1_ike_policy
/services/vpn/ike/peer{SRX240-1_t1_ike_peer}/local-identity/default	created		
/services/vpn/ike/peer{SRX240-1_t1_ike_peer}	created		
/services/vpn/ipsec/policy{SRX240-1_t1_ipsec_policy}/ciphersuite{CS1}/dh-group	value_set		dh14
/services/vpn/ipsec/policy{SRX240-1_t1_ipsec_policy}/ciphersuite{CS1}	created		
/services/vpn/ipsec/policy{SRX240-1_t1_ipsec_policy}	created		
/services/vpn/ipsec/connection{SRX240-1_t1}/local-ip-subnet	value_set		192.168.1.0/24
/services/vpn/ipsec/connection{SRX240-1_t1}/ipsec-policy	value_set		SRX240-1_t1_ipsec_policy
/services/vpn/ipsec/connection{SRX240-1_t1}/remote-ip-subnets	value_set		192.168.2.0/24
/services/vpn/ipsec/connection{SRX240-1_t1}/ike-peer	value_set		SRX240-1_t1_ike_peer
/services/vpn/ipsec/connection{SRX240-1_t1}/filter/input	value_set		IN_TRUSTED
/services/vpn/ipsec/connection{SRX240-1_t1}/filter/output	value_set		OUT_TRUSTED
/services/vpn/ipsec/connection{SRX240-1_t1}	created		

Cancel

Back Submit

Any VPN connection setup through the wizard can be modified/deleted using the wizard as well by choosing the “Modify Existing Configuration” option at the start of the wizard. The VPN wizard is designed to simplify configuration of common VPN use cases. However, in case one needs to configure some advanced setup or manipulate parameters that are not available for configuration in the wizard, one can navigate to *Services->VPN* to get full access to VPN service configuration:

**Figure 3-171. VPN – Service Configuration**

The IKE panel includes configuration for IKE policy and peer settings. When VPN wizard is used for configuration, it automatically configures the IKE policy (<name>\_<type>\_ike\_policy), IKE peer (<name>\_<type>\_ike\_peer) based on specified VPN name.





Name	Version	Mode	Auth Method	Pre Shared Key	PKI - Certificate Type	PKI - Certificate ID
SRX240-1_t1_ike_policy	ike		pre-shared-key	\$4\$E/r/VgOIRrAPxY9xcJTWQQ==		

Showing 1 to 1 of 1

Name	IKE Policy	Peer Identity No Idr	Role	Initiator Mode	Inactivity Timeout	DPD Enabled
SRX240-1_t1_ike_peer	SRX240-1_t1_ike_policy	true	initiator	always-on		true

Showing 1 to 1 of 1

**Figure 3-172. VPN - IKE Policy and IKE Peer menus**

Following additional parameters are available for configuration in IKE policy and peer entries:

- **Role** – *Responder, Initiator*.
  - **Responder** – Orbit waits for a connection from the peer.
  - **Initiator** – Orbit initiates the connection. This is the typical setup.
- **Initiator Mode** – (when role is *initiator*)
  - **Always On** - Orbit attempts to keep the tunnel always up
  - **On Demand** – Orbit sets up the tunnel only when the traffic matching the IPsec connection is detected.
- **Life Time** – *15-1440*. The time interval, in minutes, after which the IKE security association expires.
- **DPD Enabled** – *Enable, Disable*. Enabling dead peer detection (DPD) clears an established VPN connection when a dead peer is detected, and tries to establish a new one.
- **DPD Interval** – *30-3600*. Specifies the number of seconds to wait before declaring a peer “dead.” This should be set to no less than 300 seconds to reduce excess network traffic.

The IPsec panel includes configuration for IPsec policy and connection settings. When VPN wizard is used for configuration, it automatically configures the IPsec policy (<name>\_<type>\_ipsec\_policy), IPsec connection (<name>\_<type>) based on specified VPN name.



The screenshot shows two configuration panels. The top panel is titled 'IPSEC Policy' and contains a table with the following data:

Name	Life Time
SRX240-1_t1_ipsec_policy	60

The bottom panel is titled 'Connection' and contains a table with the following data:

Name	IKE Peer	IPSEC Policy	Is out of Band IMA	Failure Retry Interval	Periodic Retry Interval	Replay Window Size
SRX240-1_t1	SRX240-1_t1_ike_peer	SRX240-1_t1_ipsec_policy	false	5	60	

Figure 3-173. VPN - IPsec Policy and Connection menus

Following additional parameters are available for configuration in IPsec policy and connection entries:

- **Connection Type** – *net-to-net* or *host-to-host*. The net-to-net type signifies IPsec tunnel mode. The host-to-host type signifies the IPsec transport mode.
- **Life Time** – *15-1440*. The time interval, in minutes, after which the IPsec security association expires.
- **Failure Retry Interval** – *1-255*. The number of minutes to wait after repeated failed VPN connections before retrying.
- **Periodic Retry Interval** – *15-255*. The periodic attestation time, in minutes. Used only in IMA connections. See APPENDIX B – Integrity Measurement Authority (IMA).
- **Inbound Firewall Filter** – Apply an existing packet filter to the incoming traffic on this connection. See section 3.8.8 Access Control List (Packet Filtering / Firewall) for more information. An inbound filter to the connection must be applied, or no traffic will pass. If a filter hasn't been created specifically for the VPN connection, use the preconfigured filter *IN\_TRUSTED*, which allows all inbound traffic.
- **Outbound Firewall Filter** – Apply an existing packet filter to the outgoing traffic on this connection. See section 3.8.8 Access Control List (Packet Filtering / Firewall) for more information. An outbound filter to the connection must be applied, or no traffic will pass. If a filter hasn't been specifically created for the VPN connection, use the preconfigured filter *OUT\_TRUSTED*, which allows all outbound traffic.
- **Static NAT** – Apply an existing static Network Address Translation (NAT) rule set to the connection. See 3.8.11 Static NAT for more information

---

**NOTE** The VPN connections that are configured using the VPN service menu cannot be modified using the VPN wizard.

---

## Using the CLI

The CLI can also be used to configure VPN.



The following example describes the step-by-step VPN configuration for the example network shown in Figure 3-166.

1. Enable VPN service  
`% set services vpn enabled true`
2. Configure IKE policy with auth-method 'pre-shared-key' with password 'test123'.  
`% set services vpn policy IKE-POLICY-1 auth-method pre-shared-key`  
`% set services vpn policy IKE-POLICY-1 pre-shared-key test123`
3. Configure the following cipher suite to be included as proposal for IKE phase-1 negotiation:
  - a. Encryption Algorithm = AES 128 Bit in CBC mode
  - b. Message Authentication Algorithm = HMAC using SHA256 digest
  - c. Diffie-Hellman Group = DH-14 (group 14 modp2048)  
`% set services vpn ike policy IKE-POLICY-1 ciphersuite CS1 encryption-algo aes-128-cbc`  
`% set services vpn ike policy IKE-POLICY-1 ciphersuite CS1 mac-algo sha256-hmac`  
`% set services vpn ike policy IKE-POLICY-1 ciphersuite CS1 dh-group dh-14`

---

**NOTE** More than one cipher suite can be included in the proposal.

---

4. Create IKE peer with address 172.18.175.40 and dead peer detection enabled and interval set to 5 minutes.

The dead peer detection (DPD) is enabled by default. When enabled, it sends R\_U\_THERE/INFORMATIONAL messages to the peer if there no other data sent within DPD interval. This allows Orbit to detect dead peers and clear the connection. The DPD interval should be set to no less than 300 seconds (5 minutes) to reduce the periodic traffic in the network.

```
% set services vpn ike peer VPN-GW ike-policy IKE-POLICY-1
% set services vpn ike peer VPN-GW local-identity default
% set services vpn ike peer VPN-GW peer-endpoint address 172.18.175.40
% set services vpn ike peer VPN-GW peer-identity default
% set services vpn ike peer VPN-GW role initiator
% set services vpn ike peer VPN-GW dpd-interval 300
```

5. Create an IPsec policy and configure the following ciphersuite to be included as proposal for IKE phase-2 negotiation:

- Encryption Algorithm = AES 128 Bit in CBC mode
  - Message Authentication Algorithm = HMAC using SHA256 digest
  - Diffie-Hellman Group = DH-14 (group-14 (modp 2048)).
- ```
% set services vpn ipsec policy IPSEC-POLICY-1 ciphersuite CS1 encryption-algo aes-128-cbc
% set services vpn ipsec policy IPSEC-POLICY-1 ciphersuite CS1 mac-algo sha256-hmac
% set services vpn ipsec policy IPSEC-POLICY-1 ciphersuite CS1 dh-group dh-14
```

---

**NOTE** More than one cipher suite can be included in the proposal.

---

6. Create IPsec connection

```
% set services vpn ipsec connection VPN-GWY-CONN ike-peer VPN-GWY
% set services vpn ipsec connection VPN-GWY-CONN ipsec-policy IPSEC-POLICY-1
% set services vpn ipsec connection VPN-GWY-CONN local-ip-subnet 192.168.1.0/24
% set services vpn ipsec connection VPN-GWY-CONN remote-ip-subnet 192.168.2.0/24
% set services vpn ipsec connection VPN-GWY-CONN filter input IN_TRUSTED
% set services vpn ipsec connection VPN-GWY-CONN filter output OUT_TRUSTED
% set services vpn ipsec connection VPN-GWY-CONN failure-retry-interval 1
```



The following table describes the VPN connection attempt retries and time interval between them. After giving up as listed below, the unit waits for “failure-retry-interval” and repeats the connection attempt sequence.

**Table 3-19. VPN Connection Retry**

| <b>Attempt#</b>                                               | <b>Relative Timeout Between Attempts (secs)</b> | <b>Absolute Timeout From First Attempt (secs)</b> |
|---------------------------------------------------------------|-------------------------------------------------|---------------------------------------------------|
| 1                                                             | 0                                               | 0                                                 |
| 2 (1 <sup>st</sup> retry)                                     | 4                                               | 4                                                 |
| 3 (2 <sup>nd</sup> retry)                                     | 7                                               | 11                                                |
| 4 (3 <sup>rd</sup> retry)                                     | 13                                              | 24                                                |
| 5 (4 <sup>th</sup> retry)                                     | 23                                              | 47                                                |
| 6 (5 <sup>th</sup> retry)                                     | 42                                              | 89                                                |
| Give up                                                       | 76                                              | 165                                               |
| Wait for “failure-retry-interval”, then repeat above sequence |                                                 |                                                   |

During initial configuration set failure-retry-interval to lowest value of 1 min, to have Orbit attempt connection more quickly. This allows debugging of any connection-related issue by watching logs on peer side etc. Be sure to change this value to 5 minutes or higher to prevent excessive attempts and traffic.

Commit configuration to save the changes.

**% commit**

Following shows IKE policy configuration for public-key encryption based authentication method:

1. Create IKE policy with auth-method “public-key encryption”.
  - d. Certificate type as “rsa” if RSA public key encryption based certificates are being used.
  - e. Client certificate ID – This is the ID that was assigned to the client certificate obtained via SCEP or loaded manually (assumed to be ID-1).
  - f. Client private key ID – This is the ID that was assigned to the client private key generated during SCEP procedure or loaded manually (assumed to be ID-1).
  - g. Certificate Authority (CA) certificate ID – This is the ID that was assigned to the CA certificate obtained via SCEP or loaded manually (assumed to be CA-1).

```
% set services vpn ike policy IKE-POLICY-1 pki cert-type rsa
% set services vpn ike policy IKE-POLICY-1 pki cert-id ID-1
% set services vpn ike policy IKE-POLICY-1 pki key-id ID-1
% set services vpn ike policy IKE-POLICY-1 pki ca-cert-id CA-1
```

### Firewall Configuration

The VPN wizard automatically configures the firewall to allow incoming and outgoing IKE/IPsec traffic over the Cell/WAN interface. However, when VPN is configured manually via *Services->VPN->Basic Config* menu or via CLI, the firewall needs to be manually configured as well:

1. Add following rules to IN\_UNTRUSTED filter that is applied to the Cell interface in the incoming direction:

```
% set services firewall filter IN_UNTRUSTED rule 1 match protocol icmp
```



```
% set services firewall filter IN_UNTRUSTED rule 1 actions
% set services firewall filter IN_UNTRUSTED rule 1 actions action accept
% set services firewall filter IN_UNTRUSTED rule 2 match protocol udp
% set services firewall filter IN_UNTRUSTED rule 2 match src-port
% set services firewall filter IN_UNTRUSTED rule 2 match src-port services [ dns ]
% set services firewall filter IN_UNTRUSTED rule 10 match protocol udp
% set services firewall filter IN_UNTRUSTED rule 10 match dst-port services [ ike ntp ]
% set services firewall filter IN_UNTRUSTED rule 10 actions action accept
% set services firewall filter IN_UNTRUSTED rule 11 match protocol esp
% set services firewall filter IN_UNTRUSTED rule 11 actions action accept
% set services firewall filter IN_UNTRUSTED rule 12 match protocol all
% set services firewall filter IN_UNTRUSTED rule 12 actions action drop
```

2. Add following rules to OUT\_UNTRUSTED filter that is applied to the Cell interface in the outgoing direction:

```
% set services firewall address-set CELL-IP
% set services firewall filter OUT_UNTRUSTED rule 1 match src-address address-set CELL-IP
% set services firewall filter OUT_UNTRUSTED rule 1 match src-address add-interface-address
true
% set services firewall filter OUT_UNTRUSTED rule 1 actions action accept
% set services firewall filter OUT_UNTRUSTED rule 2 match protocol all
% set services firewall filter OUT_UNTRUSTED rule 2 actions action drop
```

3. Delete the source NAT/IP masquerading from Cell interface:

```
% delete interfaces interface Cell nat source MASQ
```

4. Commit the changes:

```
% commit
```

---

**NOTE** See section 3.8.20 Network Link failover/failback for GRE/IPsec VPN configuration examples.  
See section 12.0 APPENDIX G for more VPN configuration examples like DMVPN etc.

---

## Monitoring

### Using the Web UI

To view the VPN status, navigate to *Services->VPN-> Status*.



VPN Service ↻

Status Basic Config Actions

General

Status running

IKE

**Security Association**

Search  x

| ID | Name        | State       | Local Host     | Local ID       | Remote Host   | Remote ID     |
|----|-------------|-------------|----------------|----------------|---------------|---------------|
| 1  | SRX240-1_t1 | ESTABLISHED | 172.18.175.138 | 172.18.175.138 | 172.18.175.40 | 172.18.175.40 |

Showing 1 to 1 of 1

IPSEC

**Security Association**

Search  x

| ID | Name        | State     | Mode   | UDP Encap | In Spi   | Out Spi  |
|----|-------------|-----------|--------|-----------|----------|----------|
| 1  | SRX240-1_t1 | INSTALLED | TUNNEL | false     | c6a40f46 | 197f52f4 |

Showing 1 to 1 of 1

**Figure 3-174. VPN - Status**

Under IKE panel, click on the IKE security association row to view the detailed status.

IKE

**Security Association**

Search  x

| ID | Name        | State       | Local Host     | Local ID       | Remote Host   | Remote ID     |
|----|-------------|-------------|----------------|----------------|---------------|---------------|
| 1  | SRX240-1_t1 | ESTABLISHED | 172.18.175.138 | 172.18.175.138 | 172.18.175.40 | 172.18.175.40 |

Showing 1 to 1 of 1

**Security Association Details**

- Name: SRX240-1\_t1
- State: ESTABLISHED
- Local Host: 172.18.175.138
- Local ID: 172.18.175.138
- Remote Host: 172.18.175.40
- Remote ID: 172.18.175.40
- Initiator: true
- Initiator Spi: c7a35e49326f1d4e
- Responder Spi: 6d1d38bd7626f472
- Ciphersuite: AES\_CBC-128/HMAC\_SHA2\_256\_128/PRF\_HMAC\_SHA2\_256/MODP\_2048
- Established Time: 8 seconds
- Rekey Time: 10104 seconds
- Reauth Time: 1773488 seconds

**Figure 3-175. VPN – IKE Security Association Detailed Status**

Under IPsec panel, click on the IPsec security association row to view the detailed status.



| ID | Name        | State     | Mode   | UDP Encap | In Spi   | Out Spi  |
|----|-------------|-----------|--------|-----------|----------|----------|
| 1  | SRX240-1_t1 | INSTALLED | TUNNEL | false     | c6a40f46 | 197f52f4 |

Showing 1 to 1 of 1

### Security Association Details

|              |                               |
|--------------|-------------------------------|
| Name         | SRX240-1_t1                   |
| State        | INSTALLED                     |
| Mode         | TUNNEL                        |
| UDP Encap    | false                         |
| In Spi       | c6a40f46                      |
| Out Spi      | 197f52f4                      |
| Ciphersuite  | AES_CBC-128/HMAC_SHA2_256_128 |
| In Bytes     | 0                             |
| In Packets   | 0                             |
| In Last Use  | 1615520 seconds               |
| Out Bytes    | 0                             |
| Out Packets  | 0                             |
| Out Last Use | 0 seconds                     |
| Rekey Time   | 2548 seconds                  |
| Life Time    | 3592 seconds                  |
| Install Time | 8 seconds                     |
| Local Ts     | 192.168.1.0/24                |
| Remote Ts    | 192.168.2.0/24                |

Figure 3-176. VPN - IPsec Security Association Detailed Status

## Using the CLI

Ensure the CLI is in operational mode.

```
>show services vpn
```

```
services vpn ike security-associations security-association 11
```

```
name SRX240-1_t1
state ESTABLISHED
local-host 172.18.175.138
local-id 172.18.175.138
remote-host 172.18.175.40
remote-id 172.18.175.40
initiator true
initiator-spi b19beb547030c7c3
responder-spi 259b6cf8efb75dcc
ciphersuite AES_CBC-128/HMAC_SHA2_256_128/PRF_HMAC_SHA2_256/MODP_2048
established-time 5590
rekey-time 4584
reauth-time 1773488
```

```
services vpn ipsec security-associations security-association 40
```

```
name SRX240-1_t1
state INSTALLED
mode TUNNEL
udp-encap false
in-spi ccc45708
out-spi 127c75e1
ciphersuite AES_CBC-128/HMAC_SHA2_256_128/MODP_2048
in-bytes 0
```



```
in-packets 0
in-last-use 1615520
out-bytes 0
out-packets 0
out-last-use 0
rekey-time 1195
life-time 2202
install-time 1399
local-ts 192.168.1.0/24
remote-ts 192.168.2.0/24
```

Ping the back-office PC from the local device to make sure the traffic is passing between device and PC.

```
> ping 192.168.2.1
PING 192.168.1.2 (192.168.2.1) 56(84) bytes of data.
64 bytes from 192.168.2.1: icmp_req=1 ttl=63 time=389 ms
64 bytes from 192.168.2.1: icmp_req=2 ttl=63 time=161 ms

--- 192.168.2.1 ping statistics ---
2 packets transmitted, 2 received, 0% packet loss, time 550ms
rtt min/avg/max/mdev = 161/275/389/114 ms
```

## Troubleshooting

The following are common reasons for VPN connection failure:

1. Invalid certificate or keys loaded on the device
2. Time not synchronized on the device. Note that after cell connection is established, device can take few minutes to sync time from NTP server. VPN connection will not succeed until time is synchronized.
3. Mismatch in cipher suites configured for IKE policy on device and peer VPN gateway.
4. Mismatch in cipher suites configured for IPsec policy on device and peer VPN gateway.
5. Mismatch in remote and local IP subnets configured for IPsec connection on device and peer VPN gateway. Note the following:
  - For device
    - remote ip subnet = back-office subnet
    - local ip subnet = local LAN or WIFI subnet on device
  - For VPN gateway
    - remote ip subnet = device's local LAN or WIFI subnet
    - local ip subnet = back-office subnet on device

### 3.8.13 DHCP Service

#### Understanding

The unit can be configured to act as a DHCP server. When enabled, this service will respond to DHCP requests from any interface.

As a DHCP server, the unit can assign either IPv4 or IPv6 addresses to clients

---

**NOTE** At least one of the unit's interfaces (ETH1, ETH2, WiFi or Bridge if the interface is bridged) must be configured with an IP address from the subnet of the configured DHCP.

---





## Configuring Using the Web UI

Navigate to *DHCP Server* ---> *Basic Config*.

**DHCP Server**

Status Basic Config Advanced Config Actions

**General**

Enabled

Default Lease Time: 43200

Min Lease Time: 300

Max Lease Time: 604800

**v4subnet**

**V 4subnet**

Search  Add ... Delete

| Subnet Mask    | Range Start | Range End    | Broadcast Address | Router      | Domain Name |
|----------------|-------------|--------------|-------------------|-------------|-------------|
| 192.168.1.0/24 | 192.168.1.2 | 192.168.1.10 | 192.168.1.255     | 192.168.1.1 |             |

Showing 1 to 1 of 1

**v6subnet**

**V 6subnet**

Search  Add ... Delete

| Subnet Mask | Range Start | Range End |
|-------------|-------------|-----------|
|-------------|-------------|-----------|

Table is empty

**Figure 3-177. DHCP Menu**

The **General** drop-down contains the following options.

- **Enabled** - Enables the DHCP service. Check this box to allow the unit to act as a DHCP server.
- **Default Lease Time** – This is the amount of time, in seconds, that a client’s lease is valid. This value is only used if the client doesn’t include a lease time in its DHCP request. In IPv6 addressing, this is also known as “valid lifetime.”
- **Min Lease Time** – The minimum number of seconds that a client’s lease is valid. If a client requests a lesser minimum lease time, this value is used instead.
- **Max Lease Time** - The maximum number of seconds that a client’s lease is valid. If a client requests a greater maximum lease time, this value is used instead.

The **V4 Subnet** and **V6 Subnet** drop-downs show the currently configured DHCP subnets. Click on an entry to edit, add or delete new entries.

**DHCP Server**

Status Basic Config Advanced Config Actions

**Leases**

Search

| IP | Starts | Ends | Binding State | Client Mac | Hostname |
|----|--------|------|---------------|------------|----------|
|----|--------|------|---------------|------------|----------|

Table is empty



The **Leases** submenu located under the **Status** tab shows the DHCP leases currently assigned by the device.

## IPv4 Subnets

To add an IPv4 subnet, click the **Add** button in the **V4 Subnet** section.

**Configure V4 subnet Details**

Subnet Mask\*   
An IP address with prefix length (i.e. x.x.x.x/...)

**Figure 3-178. Adding a new DHCP IPv4 subnet**

Enter the subnet's IPv4 address and prefix and click Add. A menu appears to configure DHCP options for the subnet.

**Configure V4 subnet Details**

Range Start\*   
The starting (low) address of IP address to as...

Range End\*   
The ending (high) address of IP address to ass...

Broadcast Address    
An optional broadcast address to pass to the c...

Router    
An optional default router to pass to the clie...

Domain Name Servers

Domain Name

Ntp Servers  x

Netbios Name Servers

**Figure 3-179. Configuration options for an IPv4 subnet**

The following configuration options are required.

- **Range Start** – The start of the range of IP addresses to be assigned.
- **Range End** – The last of the range of IP addresses to be assigned.

The following configuration options are optional.

- **Broadcast Address** – Address that clients should use for broadcast messages.
- **Router** – The IP address that the client should use as its default gateway. This may be the unit's address.
- **Domain Name Servers** – A list of DNS (Domain Name Servers) that clients should use to resolve domain names.
- **Domain Name** – Domain name to pass to clients.
- **NTP Server** – A list of NTP (Network Time Protocol) servers to pass to clients. Domain names or IP addresses may be used. Entries must be separated by spaces.



- **NetBIOS Name Servers** – A list of NetBIOS name servers to pass to clients. Domain names or IP addresses may be used. Entries should be in order of preference and must be separated by spaces. NetBIOS is also referred to as “WINS.”

Once all configuration is complete, click **Save**.

## IPv6 Subnets

To add an IPv6 subnet, click **Add** in the **V6 Subnet** submenu, located in the main **DHCP** menu.

**Figure 3-180. Adding a new DHCP IPv6 subnet**

Enter the subnet’s IPv4 address and prefix and click **Add**. A menu appears to configure DHCP options for the subnet.

**Figure 3-181. Configuration options for an IPv6 subnet**

The following configuration items are required:

- **Range Start** – The start of the range of IP addresses to be assigned.
- **Range End** – The last of the range of IP addresses to be assigned.

Once all configuration is complete, click **Save**.

## Using the CLI

The following shows an example of configuring DHCP service on the unit. The unit will administer IPv4 addresses from the 192.168.x.x network when requests are received from DHCP clients.

Enter the subnet’s IPv4 address and prefix and click **Add**. A menu appears to configure DHCP options for the subnet.

---

**NOTE** At least one of the unit’s interfaces (ETH1, ETH2, WiFi or Bridge if the interface is bridged) must be configured with an IP address from this subnet.

---

```
% set services dhcp v4subnet 192.168.0.0/16 domain-name gemds range-start 192.168.1.100
range-end 192.168.1.150 router 192.168.1.1 broadcast-address 192.168.255.255 ntp-
servers [time.mds]
```

## Monitoring

For the WebUI refer to the DHCP Menu as illustrated in Figure

From the CLI in operational mode. Follow the example below to view the DHCP leases.



> show services dhcp

```
services dhcp leases 192.168.1.100
starts      2013-01-22T12:55:13+00:00
ends       2013-01-23T00:55:13+00:00
binding-state free
client-mac  70:f1:a1:fc:1d:da
hostname    ""
```

### 3.8.14 Terminal Service

#### Understanding

The unit allows the setup of the COM ports as a terminal server that passes data to/from the serial port to network interfaces. The serial port must be configured to do this, in addition to the baud rate and data format. The data from the serial port is treated as a seamless stream; meaning it is not protocol aware and will send data from the serial port to the remote endpoint as soon as the data is received. A terminal-server can be selected to be

- TCP
  - TCP Client
  - TCP Server
  - TCP Client/Server
  - MODBUS-TCP server
- UDP
  - Point-to-Point
  - Point-to-Multipoint
  - Multipoint-to-Point
  - Multipoint-to-Multipoint

When a terminal server on the unit is configured as TCP server, then the unit listens on a TCP port for client connections. When a terminal server on the unit is configured as TCP client, then the unit will attempt to connect to the remote IP address. Once a TCP connection is established, then serial traffic from the COM port can pass to and from the TCP port as long as the TCP connection remains established.

When a terminal server on the unit is configured as a MODBUS/TCP server, then the unit listens on a TCP port for a client connection. Once a TCP connection is established, the unit will convert the incoming MODBUS/TCP frame into either a MODBUS/RTU or MODBUS/ASCII frame for transmitting on the serial port. Serial data received is converted from either MODBUS/RTU or MODBUS/ASCII to MODBUS/TCP for transmission back to the MODBUS/TCP client.

When a terminal server on the unit is configured as a UDP endpoint, then traffic from the COM port is sent to the remote host at the specified port in UDP packets. Likewise, traffic sent to the UDP port of the unit is forwarded out the COM port. The UDP packets may be unicast or multicast, depending on the UDP mode. See Table 3-20. UDP Terminal Server Settings for more information. Since UDP is stateless, some packets may not reach their intended destination or may arrive out of order. The protocol contained in the UDP messages must handle these scenarios.

**Table 3-20. UDP Terminal Server Settings**

|                     | UDP RX             | UDP TX                       |
|---------------------|--------------------|------------------------------|
| Point-to-Point      | Local Address/Port | Peer Unicast Address/Port    |
| Point-to-Multipoint | Local Address/Port | Multicast Group Address/Port |



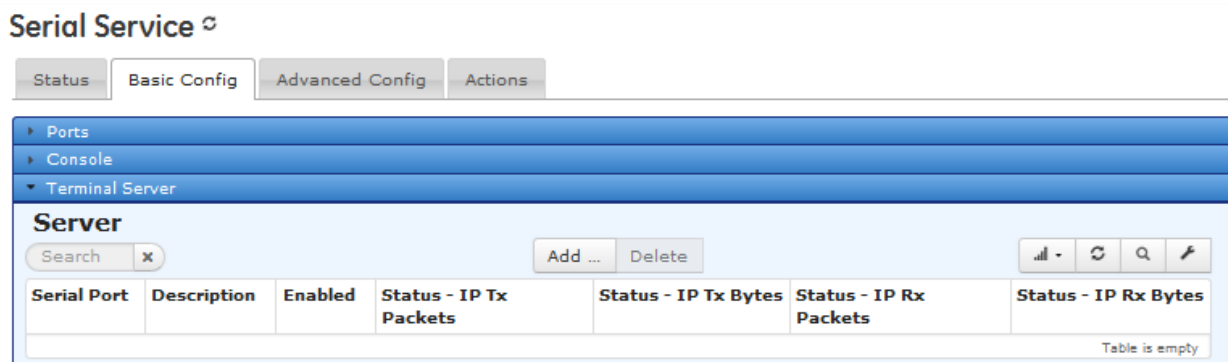
|                          |                              |                              |
|--------------------------|------------------------------|------------------------------|
| Multipoint-to-Point      | Multicast Group Address/Port | Peer Unicast Address/Port    |
| Multipoint-to-Multipoint | Multicast Group Address/Port | Multicast Group Address/Port |

**NOTE** Once a terminal-server is enabled on a COM port, the port stays in data mode and the CLI will not be available on that port. To break out of data mode, the escape sequence +++ can be entered on the PC's keyboard. The baud rate and format must match on the PC and on the unit for the escape sequence to be detected. Once the sequence is detected, the login prompt is presented as long as the port is enabled for console access.

## Basic Setup of UDP Terminal Server

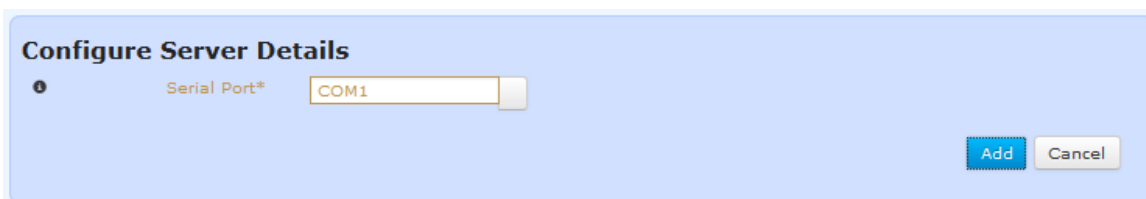
### Configuring

The following shows how to enable a UDP terminal server on COM1. Navigate to *Serial ---> Basic Config / Terminal Server*

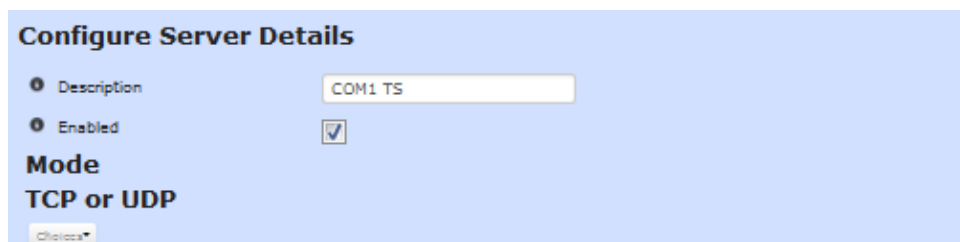


**Figure 3-182. Terminal Server Start Screen**

Click on **Add** and select the serial port for use by typing in COM1 or select after clicking on the button to the right of the field. Then, after selecting the COM port, click the **Add** button.



**Figure 3-183. Terminal Add Screen**



**Figure 3-184. Terminal Server Setup Screen**

- **Description** – A user-defined string describing the terminal server.- blank by default
- **Enabled** — Check box to allow for enabling/disabling the server
- **Mode** - Further detailed configuration information



- Click **Choices**
- Click **Udp**
- Click **Udp** check box

**Mode**  
**TCP or UDP**

Choices\*

UDP

Mode Point to Point

**Local Ips**

IPv4 Ips Add an entry ...

IPv6 Ips Add an entry ...

Port 30011

**Remote**

Address\*

Port 30011

**Figure 3-185. UDP Terminal Server Configuration Screen**

## UDP

- **Mode** – Mode of terminal server
  - Point to Point (DEFAULT)
  - Point to Multipoint
  - Multipoint to Point
  - Multipoint to Multipoint

## Local IPS

- **Ipv4 IPS** - Configure to IPv4 address or leave blank for all
- **Ipv6 IPS** - Configure to IPv6 address or leave blank for all
- **Port** - The local port of the server 0-65535 (30011 - DEFAULT)

## Remote

- **Address** – The IPv4/IPv6 address
- **Port** – The UDP port used when sending serial data to the remote address (30011 - DEFAULT)

When selecting one of the Multicast options:



**Mode**  
**TCP or UDP**

Choices▼

UDP

Mode

**Local Ips**

IPv4 Ips

IPv6 Ips

Multicast

Alternatives▼

Address\*

Port

Ttl

Figure 3-186. UDP Terminal Server Multicast Settings Screen

## Multicast

- **Address** – The multicast IPv4/IPv6 address in the form of 224.0.0.1 or FF01:::1

**Alternatives:** IPv4 or IPv6 multicast group address

- **Port** – The local port of the server 0-65535 (30011 - DEFAULT)
- **TTL** - The multicast TTL threshold used to restrict delivery of multicast frame as they pass through routers to a specified number of hops.
  - Setting TTL to a value of 0 restricts the frame to the same host.
  - Setting TTL to a value of 1 restricts the frame to the same subnet.
  - Setting TTL to a value of 32 restricts the frame to the same site.
  - Setting TTL to a value of 64 restricts the frame to the same region.
  - Setting TTL to a value of 128 restricts the frame to the same continent.
  - Setting TTL to a value of 255 unrestricts the frame.

## Basic Setup of a TCP Terminal Server

Start the same initial settings as were done for UDP setup.

- Click **Choices**
- Click **TCP Server**
- Click **TCP Server** check box



Mode  
TCP or UDP  
Choices\*

TCP Server  
**Local Ips**

Ipv4 Ips      Add an entry ...

Ipv6 Ips      Add an entry ...

Port      30011

Idle Timeout      30

Figure 3-187. TCP Terminal Server Settings Screen

### Local IPS

- **Ipv4 IPS** - Configure to IPv4 address or leave blank for all
- **Ipv6 IPS** - Configure to IPv6 address or leave blank for all
- **Port** – The local port of the server 0-65535 (30011 - DEFAULT)
- **Idle Timeout** - The time interval (in secs) after which a tcp connection is disconnected if there is no data activity to/from the client (30 sec DEFAULT)

If **TCP Client / Server** is selected, options for both TCP Client and TCP Server are available below displays the client side configuration.

Mode  
TCP or UDP  
Choices\*

TCP Server  
 TCP Client  
**Remote**

Address\*     

Port      30011

Idle Timeout      30

Figure 3-188. TCP Terminal Client Settings Screen

### Remote

- **Address** – The IPv4/IPv6 address used when sending serial data.
- **Port** – The local port of the server 0-65535 (30011 - DEFAULT)
- **Idle Timeout** - The time interval (in secs) after which a tcp connection is disconnected if there is no data activity to/from the client (30 sec DEFAULT)s

### Basic Setup of Modbus Terminal Server

Start the same initial settings as were done for UDP setup.

- Click **Choices**
- Click **Modbus TCP**
- Click **Modbus TCP** check box



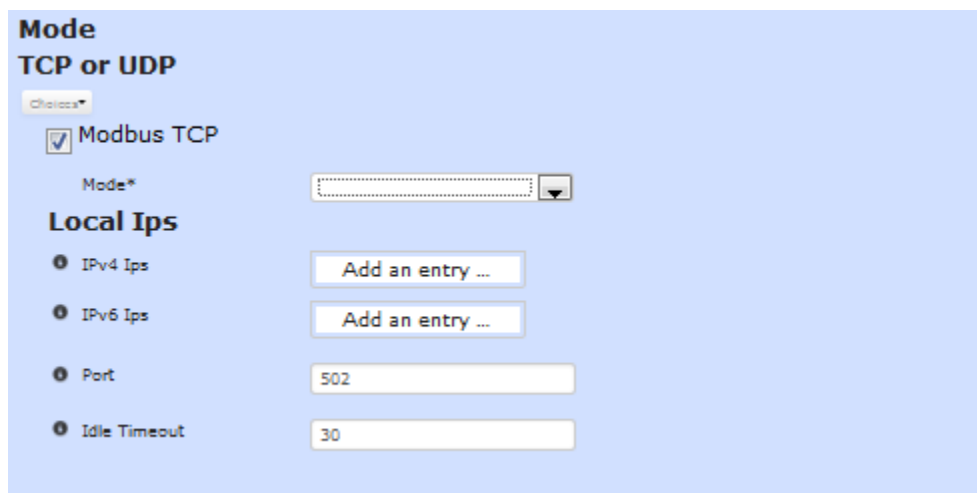


Figure 3-189. Terminal Server Modbus TCP Settings Screen

### Modbus TCP

- **Mode** – Mode for the Modbus server
  - **RTU** – Convert from Modbus/TCP to Modbus/RTU
  - **ASCII** – Convert from Modbus/TCP to Modbus/ASCII

### Local IPS

- **Ipv4 IPS** - Configure to IPv4 address or leave blank for all
- **Ipv6 IPS** - Configure to IPv6 address or leave blank for all
- **Port** — The local port of the server 0-65535 (502 - DEFAULT)
- **Idle Timeout** - The time interval (in secs) after which a tcp connection is disconnected if there is no data activity to/from the client (30 sec DEFAULT)

### UDP Multicast (Point to Multipoint) Server Setup Example

When the Terminal Server is configured to operate in either the Point-to-Multipoint or Multipoint-to-Multipoint UDP mode, a static route must be created to direct how the unit handles the transmission of the multicast UDP packets. This static route must define the “Outgoing Interface” for the Orbit to use to get to a Destination Prefix of the full multicast subnet of “224.0.0.0/4”.

It is also recommended that a multicast static route be configured on each multipoint unit.

---

**NOTE** If a unit participates in multiple multicast groups, and each of these groups are accessible via different interfaces, then a separate static route must be created for each group and interface combination (i.e. 224.0.0.3/32 via ETH1 and 224.0.0.4/32 via ETH2), instead of the full multicast subnet.

---

### Summary of Configuration Steps (be sure to follow these steps in order):

1. Configure an IPv4 Static-Route for the Multicast Subnet.(Static Neighbor Entries)
  - Configure Destination Prefix (dest-prefix)
  - Configure Outgoing Interface (outgoing-interface)
2. Configure Orbit Serial Terminal Server
  - Configure which Serial Port to use as Terminal Server
  - Configure UDP as Protocol
  - Configure UDP Mode to use **Point-to-Multipoint**

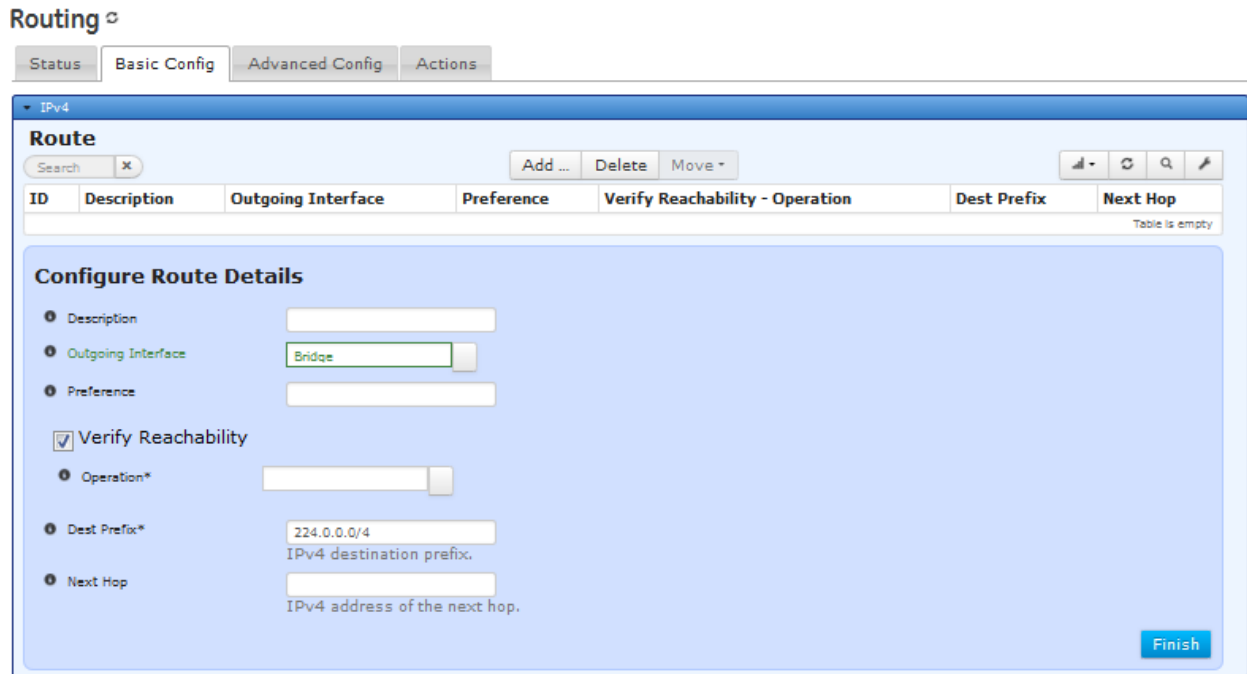


- Configure remaining Terminal Server parameters, i.e. Local listening port, Remote port, Remote IP, Multicast port, Multicast IP

3. Save/Commit Configuration

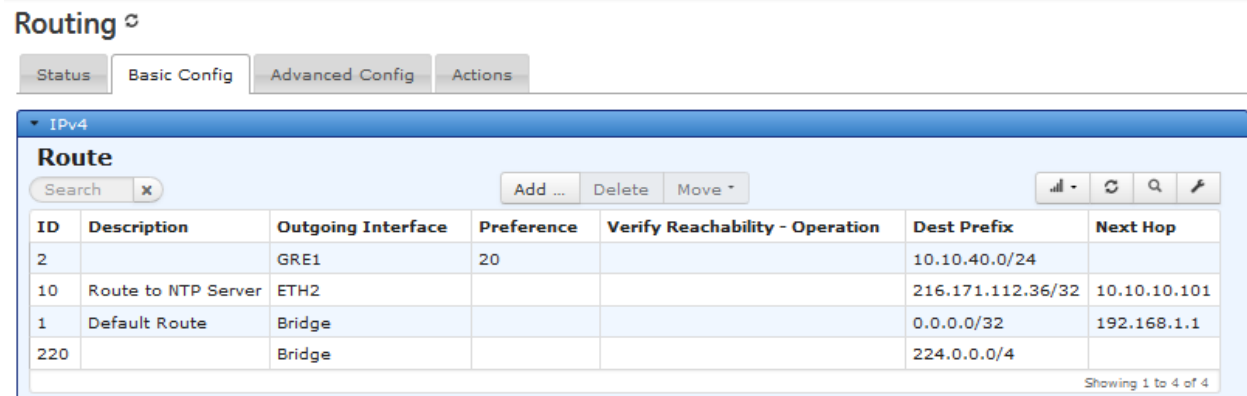
**Step by step walkthrough - Web Based Configuration:**

1. On the left hand side of the Web GUI, click Routing.
2. Navigate to Routing ---> Basic Config / IPv4
3. Click on +Add
4. Type a numeric ID (220) which will be used to identify this route and click “Add”
5. Enter the following: 224.0.0.0/4 - This destination prefix will cover the entire Multicast Subnet, and send all Multicast data out of the Bridge interface.



**Figure 3-190. Example: Static Route Settings**

6. Save the configuration.
7. View the finished IPv4 Route table to view that the route is present:



**Figure 3-191. Example: Route Page**

**NOTE** Step #8 & #9 are ONLY if the user has a Terminal Server already configured in their system. Otherwise proceed to Step #10



8. Navigate to Serial ---> Basic Config / Terminal Server
9. Disable and re-enable the Terminal Server.
  - Click to select the Serial Port,
  - Un-check the Enabled box
  - Save
10. Re-check the Enabled box and then Save.
11. Repeat this on each Multipoint unit.
12. Click on **Add** then select the COM port to use as a Terminal Server and then **OK**.
13. Configure the COM port;
  - Click **Choices**
  - Click **Udp**
  - Click **Udp** check box
14. Configure the UDP Mode that best fits the system, configure any local ports, remote ports/IPs, and Multicast ports/IPs.

Figure 3-192. Example: UDP TS Configuration

15. Save the configuration

### Command Line Interface (CLI):

**NOTE** Change plain *text/italics* as appropriate to set up the system

Configure the following:

```
% set routing static-routes ipv4 route 220 dest-prefix 224.0.0.0/4 outgoing-interface Bridge
% set services serial terminal-server server YOURPORT mode udp mode point-to-multipoint
port 30015 multicast port 30016 address 224.100.0.5
% commit
```

### Configuring via the CLI

The following shows how to configure and enable a UDP terminal server on COM1:



```
% set services serial terminal-server server COM1 mode udp port 10000 remote address
192.168.1.12 port 10000
% commit
```

The following shows how to enable a TCP terminal server on COM1:

```
% set services serial terminal-server server COM1 mode tcp-server port 30011 idle-timeout
30
% commit
```

## Monitoring

Each Terminal server has the same statistic information. Navigate to terminal server and select the server. For example for a COM1 server - navigate to *Serial* ---> *Basic Config / Terminal Server* and then click on **COM1**. The Terminal Service **Status** will be located at the end of the Server Details.



**Figure 3-193. Terminal Server on COM1 Status Information**

- **IP Tx Packets** - The number of IP packets transmitted
- **IP Tx Bytes** - The number of IP bytes transmitted
- **IP Rx Packets** - The number of IP packets received
- **IP Rx Bytes** - The number of IP bytes received
- **Serial Tx Packets** - The number of serial packets transmitted
- **Serial Tx Bytes** - The number of serial bytes transmitted
- **Serial Rx Packets** - The number of serial packets received
- **Serial Rx Bytes** - The number of serial bytes received

From the CLI - ensure the CLI is in operational mode. Follow the example below to view the state and statistics:

```
> show services serial
```

| SERIAL PORT | IP TX PACKETS | IP TX BYTES | IP RX PACKETS | IP RX BYTES | SERIAL TX PACKETS | SERIAL TX BYTES | SERIAL RX PACKETS | SERIAL RX BYTES |
|-------------|---------------|-------------|---------------|-------------|-------------------|-----------------|-------------------|-----------------|
| COM2        | 0             | 0           | 0             | 0           | 0                 | 0               | 0                 | 0               |

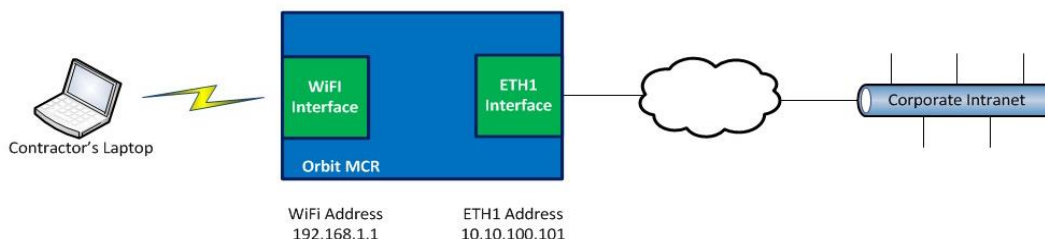
## 3.8.15 Remote Management Interfaces

### Understanding

The Orbit MCR supports remote device management via SSH, HTTP/HTTPS, SNMP and NETCONF. Each of these services can be configured to only listen to specified IP addresses configured on the system. This may be useful if there are multiple networks being routed between and it is not desirable to expose management interfaces via one or more of the networks.



For example, consider the case shown in the figure below. An Orbit MCR, located at a remote site, maintains a connection to the backhaul network on its ETH1 connection, and also serves as a WiFi access point. The contract technicians who visit the remote site need to be able to use the WiFi connection so that they can access the corporate intranet through the MCR, but the system administrators have determined that they should not be able to manage the MCR or change its configuration. Therefore, device management is allowed solely on ETH1's IP address.



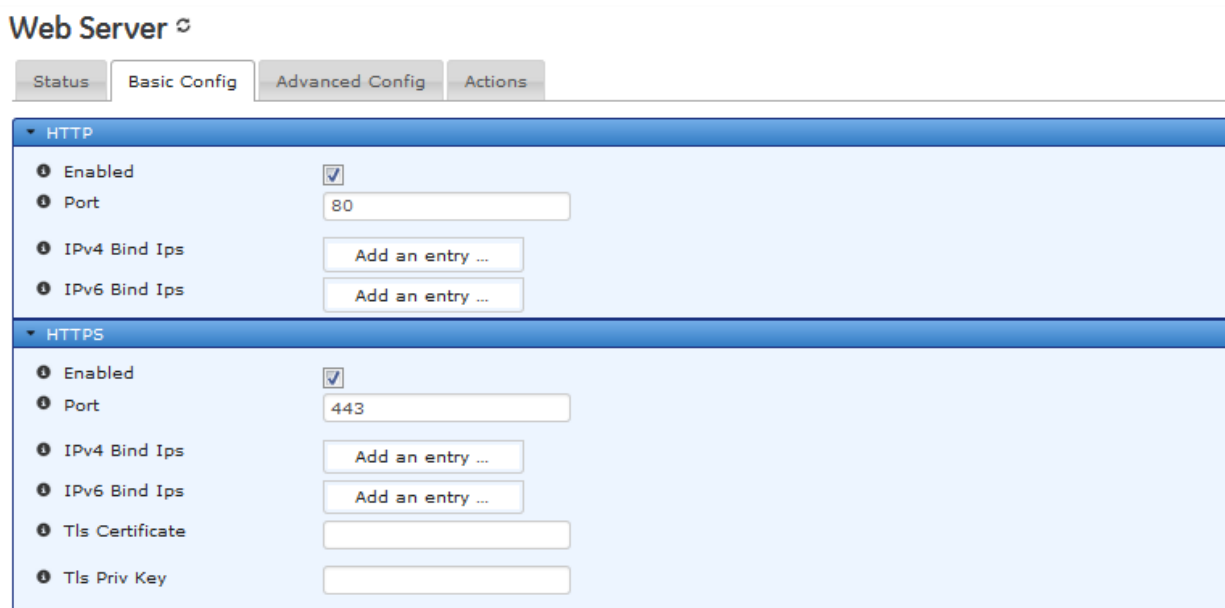
**Figure 3-194. Device Management Example Network.**

A contractor's laptop should be able to access the corporate intranet through the WiFi connection, while remaining unable to manage the MCR.

## Configuration

### Web UI - HTTP/HTTPS Configure

To limit services to a specific statically assigned IP address, navigate to **Web Server** ---> **Basic Config** menu.



**Figure 3-195. Web Services network**

## HTTP

- **Enabled** - Enable (Default) or Disabled Service.
- **Port** - The port to listen to HTTP connections on Valid values: 0—65535 -Default: 80
- **IPv4 Bind IPs** - Restrict the server to only listen for connections on the specified IPv4 addresses. If not present, or empty, the server will listen on all IPv4 addresses.



- **IPv6 Bind IPs** - Restrict the server to only listen for connections on the specified IPv6 addresses. If not present, or empty, the server will listen on all IPv6 addresses.

## HTTPS

- **Enabled** - Enable (Default) or Disabled Service.
- **Port** - The port to listen to HTTPS connections on Valid values: 0—65535 -Default: 443
- **IPv4 Bind IPs** - Restrict the server to only listen for connections on the specified IPv4 addresses. If not present, or empty, the server will listen on all IPv4 addresses.
- **IPv6 Bind IPs** - Restrict the server to only listen for connections on the specified IPv6 addresses. If not present, or empty, the server will listen on all IPv6 addresses.
- **TLS Certificate** - The certificate to use for the HTTPS server. If empty or not present, a self-signed certificate/key pair will be used.
- **TLS Private Key** - The private key which matches the specified TLS-certificate. If empty or not present, a self-signed certificate/key pair will be used.

As show in the screen above both HTTP and HTTPS web services can be used to manage the MCR.

Click **Add an Entry** next to **IPv4 Bind IPs** or **IPv6 Bind IPs** in each submenu to access a dropdown box containing all IP addresses on the device. Select the IP address belonging to the appropriate interface, and click **Add**.

The screenshot shows the 'Web Server' configuration page with tabs for Status, Basic Config, Advanced Config, and Actions. The 'HTTP' section is expanded, showing the following settings:

- Enabled**:
- Port**:
- IPv4 Bind Ips**:
- IPv6 Bind Ips**:

Buttons for 'Update', 'Add', and 'Cancel' are visible at the bottom right of the configuration area.

Figure 3-196. HTTP Restricted IP

Once configuration is complete, click **Save**.

## Web UI - SNMP Configure

To configure SNMP to listen only to a specific address, navigate to *SNMP Agent* ---> *Basic Config*.



## SNMP Agent ↻

|                    |                                                 |                                           |                                                   |
|--------------------|-------------------------------------------------|-------------------------------------------|---------------------------------------------------|
| Status             | Basic Config                                    | Advanced Config                           | Actions                                           |
| Registration       |                                                 |                                           |                                                   |
| Contact            | <input type="text"/>                            |                                           |                                                   |
| Name               | <input type="text"/>                            |                                           |                                                   |
| Location           | <input type="text"/>                            |                                           |                                                   |
| Agent              |                                                 |                                           |                                                   |
| Enabled            | <input checked="" type="checkbox"/>             |                                           |                                                   |
| IPv4 Bind Ips      | <input type="button" value="Add an entry ..."/> |                                           |                                                   |
| IPv6 Bind Ips      | <input type="button" value="Add an entry ..."/> |                                           |                                                   |
| Port               | <input type="text" value="161"/>                |                                           |                                                   |
| Max Message Size   | <input type="text" value="50000"/>              |                                           |                                                   |
| Debug Enabled      | <input type="checkbox"/>                        |                                           |                                                   |
| Agent Version      |                                                 |                                           |                                                   |
| V 1                | <input checked="" type="checkbox"/>             |                                           |                                                   |
| V 2c               | <input checked="" type="checkbox"/>             |                                           |                                                   |
| V 3                | <input checked="" type="checkbox"/>             |                                           |                                                   |
| Agent Engine ID    |                                                 |                                           |                                                   |
| Enterprise Number* | <input type="text" value="4130"/>               | Method                                    |                                                   |
|                    |                                                 | <input type="button" value="Choose ..."/> |                                                   |
|                    |                                                 | <input type="radio"/>                     | From Mac <input checked="" type="checkbox"/>      |
|                    |                                                 |                                           | Generate the SNMP engine ID based on the ether... |

**Figure 3-197. Accessing the SNMP menu**

Click **Add an Entry** next to **IPv4 Bind IPs** or **IPv6 Bind IPs** in the **Agent** submenu to access a dropdown box containing all IP addresses on the device. Select the IP address belonging to the appropriate interface, and click **Add**. Once configuration is complete, click **Save**.

## Web UI - SSH Configure

To configure SSH to listen only to a specific address, navigate to **SSH Server** ---> **Basic Config**.

## SSH Server ↻

|               |                                                 |                 |         |
|---------------|-------------------------------------------------|-----------------|---------|
| Status        | Basic Config                                    | Advanced Config | Actions |
| General       |                                                 |                 |         |
| Enabled       | <input checked="" type="checkbox"/>             |                 |         |
| Port          | <input type="text" value="22"/>                 |                 |         |
| IPv4 Bind Ips | <input type="button" value="Add an entry ..."/> |                 |         |
| IPv6 Bind Ips | <input type="button" value="Add an entry ..."/> |                 |         |

**Figure 3-198. SSH Menu**

- **Enabled** - Whether or not to run the netconf server. Default = true
- **Port** - The port to listen to netconf connections on. Default=830
- **IPv4 Bind IPs** - Restrict the server to only listen for connections on the specified IPv4 addresses. If not present, or empty, the server will listen on all IPv4 addresses.
- **IPv6 Bind IPs** - Restrict the server to only listen for connections on the specified IPv6 addresses. If not present, or empty, the server will listen on all IPv6 addresses.



Click **Add an Entry** next to **IPv4 Bind IPs** or **IPv6 Bind IPs** to access a dropdown box containing all IP addresses on the device. Select the IP address belonging to the appropriate interface, and click **Add**. Once configuration is complete, click **Save**.

## Web UI - NetConf Configure

To configure NETCONF to listen only to a specific address, navigate to *NETCONF Server* ---> *Basic Config*

**Figure 3-199. NETCONF Menu**

- **Enabled** - Whether or not to run the netconf server. Default = true
- **Port** - The port to listen to netconf connections on. Default = 830
- **IPv4 Bind IPs** - Restrict the server to only listen for connections on the specified IPv4 addresses. If not present, or empty, the server will listen on all IPv4 addresses.
- **IPv6 Bind IPs** - Restrict the server to only listen for connections on the specified IPv6 addresses. If not present, or empty, the server will listen on all IPv6 addresses.

Click **Add an Entry** next to **IPv4 Bind IPs** or **IPv6 Bind IPs** to access a dropdown box containing all IP addresses on the device. Select the IP address belonging to the appropriate interface, and click **Add**. Once configuration is complete, click **Save**.

## CLI Configure

To configure the services to only listen to a specific statically assigned IP address the following commands would be used:

```
% set services web http ipv4-bind-ips [192.168.1.1]
% set services web https ipv4-bind-ips [192.168.1.1]
% set services snmp ipv4-bind-ips [192.168.1.1]
% set services ssh ipv4-bind-ips [192.168.1.1]
% set services netconf ipv4-bind-ips [192.168.1.1]
```

These remote management interfaces can also be bound to IPv6 address by using “ipv6-bind-ips” instead of “ipv4-bind-ips”. If these settings are not configured, the default behavior is to listen on all IP addresses in the system.





## Monitoring

Use the CLI command `% show services` to view each service configuration.

```

> show services
NAME                STATUS
-----
VPN                  disabled
Serial               running
Firewall             running
DHCP Server          running
SSH Service          running
WEB Service          running
IPerf Server         running
SNMP Service         running
NETCONF Service     running
Quality of Service   running

```

| SERIAL PORT | IP TX PACKETS | IP TX BYTES | IP RX PACKETS | IP RX BYTES | SERIAL TX PACKETS | SERIAL TX BYTES | SERIAL RX PACKETS | SERIAL RX BYTES |
|-------------|---------------|-------------|---------------|-------------|-------------------|-----------------|-------------------|-----------------|
| COM2        | 0             | 0           | 0             | 0           | 0                 | 0               | 0                 | 0               |

### 3.8.16 Remote Management Service

#### Understanding

The Remote Management Service provides effective remote management using minimum bandwidth. It is especially useful with connections that use a narrow channel, such as the NX and LN interfaces.

The Remote Management Service allows you to use the web UI of a radio to manage a second radio remotely. You can also perform a broadcast firmware update from one radio (typically the AP) to other radios in the network.

Standard Web UI sessions and individual radio firmware push are prohibitively expensive on low bandwidth channels. Remote management offers a far less bandwidth-intensive means to perform these tasks.

As an example, consider the simple network below. A user maintains a network connection to the local radio with IP address, 192.168.1.10. The local radio is part of a narrowband network that includes three remote radios. The user would like to access the remote radio at IP address 192.168.1.65 to check its current configuration. It takes some time to view the web interface of a remote radio over a narrowband channel. Accessing the remote configuration through the Remote Management Service's web proxy client is significantly faster.



Figure 3-200 Narrowband example network.

## Configuration

### Using the WebUI

Navigate to *Services->Remote Management* and click the **Basic Config** tab.

## Remote Management Service

Configuration tabs: Status | **Basic Config** | Advanced Config | Actions

|                         |                                                                                                                           |
|-------------------------|---------------------------------------------------------------------------------------------------------------------------|
| ▼ General               |                                                                                                                           |
| Enabled                 | <input checked="" type="checkbox"/>                                                                                       |
| Interfaces              | <div style="border: 1px solid gray; padding: 2px;">Bridge <span style="float: right;">×</span><br/>Add an entry ...</div> |
| Shared Secret           | .....                                                                                                                     |
| ▼ Firmware              |                                                                                                                           |
| Enabled                 | <input checked="" type="checkbox"/>                                                                                       |
| ▼ Web Proxy Client      |                                                                                                                           |
| Enabled                 | <input checked="" type="checkbox"/>                                                                                       |
| ▼ Web Proxy Server      |                                                                                                                           |
| Allow Client Connection | <input checked="" type="checkbox"/>                                                                                       |

Figure 3-201 Basic configuration for Remote Management



---

**NOTE** Remote Management operates on the following IP addresses and ports. Ensure that they are not blocked by your firewall settings, or the service will not operate properly.

**Firmware Reprogramming**

|               |                         |               |
|---------------|-------------------------|---------------|
| Address       | 230.4.4.1               | UDP Port 1044 |
| Address Range | 230.5.5.0 – 230.5.5.255 | UDP Port 1044 |
| UDP Port      | 40010                   |               |

**Web Proxy**

TCP Port 4580  
TCP Port 8080

---

The following options are present on the Basic Config menu.

**General**

- **Enabled** – Enables the Remote Management Service. Enabled by DEFAULT.
- **Interfaces** – Enter one or more network interfaces on which the Remote Management Service should run. If a desired network interface is present in a bridge, you must enter the bridge's name in this field.
- **Shared Secret** – A shared secret used to allow remote connections to or from the device. It must be the same on both sides of the connection. For greater security, we recommend that you change this password and do not use the default. DEFAULT *rmadmin*

**Firmware**

- **Enabled** – Enables the unit to either push firmware to other Orbit devices on the network, or receive firmware pushed by other devices. This feature must be enabled on both sending and receiving devices. Enabled by DEFAULT.

**Web Proxy Client**

- **Enabled** – Enables the unit to open a web UI session on a remote Orbit device. The remote device must have the Web Proxy Server feature enabled. Enabled by DEFAULT.

**Web Proxy Server**

- **Allow Client Connection** – Allows other Orbit devices on the network that have enabled the Web Proxy Client to open a remote web UI session to this unit. Enabled by DEFAULT.

To initiate a remote web proxy or over the air reprogramming session, access the Actions menu at **Services->Remote Management->Actions**.



## Cancel Session and Reboot Remote Devices

### Remote Management Service

Status Basic Config Advanced Config Actions

Cancel Session

### Cancel Session

Perform action

Reboot Remote Devices

### Reboot Remote Devices

Interface \*

Image Version \* 

- version "4.0.4" (Current active image 1)
- version "4.0.2" (Inactive image 2)

Reboot selected version

Figure 3-202 Cancel Remote Session and Reboot Remote Devices options

To cancel an active remote reprogramming or web proxy session, expand the **Cancel Session** menu and click **Perform Action**.

**Reboot Remote Devices** sends a request across the selected interface for all Orbit units on the network to reboot to the specified image version. The Remote Management Service must be enabled on each remote radio in order for them to receive the request.

- **Interface** – The network interface on which to transmit the reboot request. If a desired network interface is present in a bridge, you must enter the bridge's name in this field.
- **Image Version** – Select either onboard firmware version. Each remote Orbit unit that receives the request will reboot to this version of firmware *if* it is present. If the remote unit does not currently have the specified firmware version, it will ignore the reboot request.



## Send Local Firmware

Send Local Firmware

**Send Local Firmware**

Interface \*

Image \* 1 - version "4.0.4" (Current active image)  
2 - version "4.0.2" (Inactive image)

TX Rate

Block Size

Reboot Remotes On Completion

Send selected image

Figure 3-203 Send Local Firmware menu

Use the **Send Local Firmware** menu to send a firmware image to Orbit radios on the network. The Remote Management Service must be enabled on each remote radio in order for them to receive the request. Remote reprogramming can be used to push firmware from an access point to all remote radios at once, while limiting the reprogramming operation's use of the channel to prevent interference with data traffic. It is ideally suited for networks that operate on narrow channel sizes, such as Orbit NX915 and LN.

The sending radio makes three attempts to send a firmware image through multicast. Firmware data is sent as a series of blocks. Only blocks that were not received by a remote in the previous cycle are resent. To prevent flooding the network with reprogramming traffic, the firmware push is automatically constrained as a best-effort service, and TX Rate and Block Size parameters are set to their most conservative values.

- **Interface** – The network interface on which to transmit the reboot request. If a desired network interface is present in a bridge, you must enter the bridge's name in this field.
- **Image Version** – Select either onboard firmware image.
- **TX Rate** – Desired firmware transfer rate, in kbps. You may also enter -1 to transfer data as fast as the network will allow, or -2 to transfer data as fast as may be sustained by the slowest peer. -2 to 1000000, DEFAULT 1.
- **Block Size** – Number of bytes per data block. 512 to 1300, DEFAULT 512.
- **Reboot Remotes on Completion** – Disabled by DEFAULT. If this option is selected, remote units will automatically reboot to the new firmware once they have successfully received and verified the firmware image.

Detailed statistics are currently unavailable for remote reprogramming, but you may view a remote unit's event log to determine that it has opened a remote reprogramming session, completed successfully, or finished unsuccessfully. You can also monitor the transfer status by viewing the AP's event log to see that it has begun or finished a remote transfer session.



## Web Proxy Client

Web Proxy Client

### Start Connect

Server IP Address

Perform action

**Figure 3-204 Web Proxy Client menu**

Use the Web Proxy Client to open a web UI session on a remote Orbit device. The target device must have the Web Proxy Server feature enabled.

The Web Proxy Client is intended primarily as a means to configure a remote unit. Actions that may be performed remotely are limited. For example, you may not use the remote web UI to reprogram the remote unit, or import or export configuration files.

The Web Proxy Client opens the remote device's web UI using the IP address of the *local* unit, and port 8080. Only HTTP connections, not HTTPS, are possible at the present time.

- **Server IP Address** – Enter the IPv4 address of the remote unit that you wish to connect to.

When you click **Perform Action**, a new browser tab opens that contains the remote web UI. To show that the web UI is a remote session, the webpage header reads “**GE MDS Device Management (Remote).**”

Popup blockers on some web browsers may block the new webpage that is launched. If the new window is blocked, disable the popup blocker or configure it properly to allow popups from the Orbit device.

The local connection and remote connection cannot be active at the same time. When the remote web UI session begins, the local connection is closed. Similarly, if you open a new local web UI session, the remote web session closes.



Figure 3-205 Remote web UI session. Notice the "[Remote]" designation appended to the page header.

### Remote Web Connect: LnRadio and NxRadio Interfaces

You may also open a remote web UI session on Orbit LnRadio and NxRadio interfaces' status menus, if the local radio is serving as an access point. To do so, navigate to **Interfaces->LnRadio->Status** or **Interfaces->NxRadio->Status**, and expand the **LN Radio** or **NX Radio** menu, as applicable. In the **Connected Remotes** list, highlight the intended remote unit, and click **Remote Web Connect**.

| Address           | IP Address    | Time to Live | Link Status | Nic ID | Avg RSSI | Avg Evm |
|-------------------|---------------|--------------|-------------|--------|----------|---------|
| 00:06:3d:08:fd:7a | 192.168.54.84 | 426          | associated  | 1      | -70      | 2       |

Showing 1 to 1 of 1

| Address | IP Address | Time to Live | Remote Address | Device Stats - Tx Packets | Device Stats - Tx Bytes | Device Stats - Rx Packets |
|---------|------------|--------------|----------------|---------------------------|-------------------------|---------------------------|
|---------|------------|--------------|----------------|---------------------------|-------------------------|---------------------------|

Figure 3-206 Connected Remotes display, LN or NX radios



As stated before, only one connection to either the remote radio or the local radio can be opened at a time.

## Status

Navigate to *Services->Remote Management->Status*.

| IP Address   | Status                               |
|--------------|--------------------------------------|
| 192.168.1.15 | 18 blocks to be sent. Please wait... |
| 192.168.1.16 | Sent block 7 of 26 (26%)             |
| 192.168.1.17 | Sent block 5 of 24 (20%)             |

Figure 3-207 Remote Management Service status menu

### General

- **Status** – Displays whether the service is currently running.

### Web Proxy Client

- **Status** – The current state of the web proxy client.
  - Disabled – The radio is currently not connected to a remote web UI.
  - Operating – A remote web UI session to another radio is currently open.

### Web Proxy Server

- **Status** – The current state of the web proxy server.
  - Disabled – The unit is not accepting remote web connection requests.
  - Operating – The unit may be managed remotely through a remote web UI session.





## Firmware Reprogram

- **Status** – The current state of the firmware reprogramming process. This applies to both the sending and receiving devices.
- **Peer Database (Sending device only)** – During an active transfer, a table showing the IP address and status of each participating receiving device will be displayed. If there is no active transfer, the status of the last send operation will be shown for each device.

## Using the CLI

To configure Remote Management, ensure that the CLI is in configuration mode.

Use the following command to enable the Remote Management service on the Bridge interface, with a shared secret of *rmadmin*.

```
% set services remote-management enabled true interfaces Bridge shared-secret rmadmin
```

Use the following commands to enable the radio to send or receive firmware remotely, as well as manage or be managed through a remote web UI session.

```
% set services remote-management firmware enabled true  
% set services remote-management web-proxy-client enabled true  
% set services remote-management web-proxy-server enabled true
```

You may perform remote management actions in either operational or configuration mode. The following command requests remote units to reboot to image version 4.0.4.

```
% request services remote-management reboot-remote-devices interface Bridge which-image { version 4.0.4 }
```

The following command requests remote units to reboot to the active image version of the *current* radio. For example, if the local radio's active firmware image is version 4.0.0, remote radios will receive a request to reboot to firmware version 4.0.0.

```
% request services remote-management reboot-remote-devices interface Bridge which-image { active }
```

The following command initiates a remote reprogramming session of the current radio's active image over the Bridge interface, with a blocksize of 512, at a rate of 500 kbps. Remotes are requested to reboot to the new image upon successful completion.

```
% request services remote-management send-local-firmware blocksize 512 interface Bridge reboot-remotes-on-completion true txrate 500 which-image { active }
```

Use the following command to cancel the currently active remote reprogramming or management session.

```
% request services remote-management cancel-session
```

## Monitoring

To view the current Remote Management status, ensure that the CLI is in operational mode.

```
% show services remote-management-status  
services remote-management-status web-proxy-client status disabled  
services remote-management status web-proxy-server status operating
```



### 3.8.17 Quality of Service (QoS)

#### Understanding

Quality of service (QoS) allows the MCR radio to classify network traffic giving preference to different types of traffic before it is transmitted out of the MCR. Each interface has a packet queue that will hold packets that are going to be transmitted out of the interface while the interface is busy. If the interface is saturated with traffic, the interface will report busy and the packet queue will hold the packet. Normally the packet the queue sends the packets to the interface in the order it receives them, but QoS allows a different behavior. Depending on the policy applied to the interface, the packets that are in the queues backlog can be sent to the interface in a different order that it was received based on fairness or the priority of the packet.

There are currently three types of QoS policies that can be applied to an interface; prioritization, shaping and fairness.

Prioritization implements a strict priority scheduler that requires classifiers be set up to give traffic different priorities. The prioritization policy will always send highest priority traffic first. Excessive high priority traffic can prevent any lower priority traffic from being sent.

The fairness policy attempts to split up the traffic into different groups based on the packets IP addresses and IP protocols. It services these groups in a round robin fashion to ensure one traffic flow does not prevent others from using the link. The fairness policy determines traffic flows on its own and does not need the user to set up classifiers for it.

Traffic shaping is used to set minimal and maximal rates for a class of traffic. For example, with business critical traffic like SCADA, traffic shaping can be setup to guarantee that this class of traffic will always have at least 100Kbyte/s of an 800Kbyte/s link, regardless of the amount of other traffic. The remaining unclassified traffic can use the entire 800Kbyte/s link as long as there is no SCADA traffic, but as soon as SCADA traffic resumes, it will be given at least 100Kbyte/s allocation of the bandwidth. Additionally, a maximal rate could be applied to a class of traffic to prevent that class from consuming too much of a link. For example, a video stream could be limited to using 400Kbyte/s of an 800Kbyte/s link to prevent it from interfering with any other traffic or to prevent it from saturating a radio interface.

A special QoS policy type, called **modify**, provides the ability to modify fields in an IP packet before they egress an interface. This policy does not need to be applied to an interface for it to be used. Creating the policy with at least one classifier enables the policy and any traffic matching the classifiers will be modified accordingly. The modifications that can be performed are setting the ToS or DSCP value in IP packets.

The modify policy is particularly useful when using GRE tunnels over a cellular interface and the cellular interface is capable of prioritizing packets based on ToS/DSCP values. In this scenario, the GRE tunnel inherits the ToS/DSCP value of the tunneled traffic. When the proper classifiers are created, designated traffic flows inside the tunnel will have priority when egressing the cellular interface.

Any QoS policy can be applied to the MCR's non-virtual interfaces (i.e. Wi-Fi, NX915, LNxxx, etc.) or a class in a class-full policy.

The classifiers mark the packets as they travel through the system. This mark is used when the packet gets to the queue, to put it in its proper class. Packets can be classified based on the following parameters:



In the IPv4 headers:

- IP protocol
- Source address
- Source port
- Destination address
- Destination port
- DSCP value
- TOS value

In the Ethernet header:

- Ether-type
- Source address
- Destination address
- VLAN ID
- VLAN priority
- VLAN encapsulated ether-type

The following figures show a simplified relationship between the packet classifiers and the packet queues.



**Figure 3-208. Packet classification for locally generated traffic**



**Figure 3-209. Packet classification of routed traffic**



**Figure 3-210. Packet classification of bridged traffic**

It is important to note that the Ethernet classifiers are only pertinent to traffic that is bridged through the system.

By design, Orbit QoS will affect data priorities if and only if the interface is saturated.

For example, QoS configured as:

- GOOSE traffic treated as the highest priority.
- VLAN 101 traffic treated as the next lowest priority.
- All remaining traffic treated as the lowest priority.

In this case, QoS is invoked only when traffic is queued due to exceeding maximum throughput. GOOSE traffic would be given highest priority and be sent over the air first, followed by any VLAN 101 traffic and then all remaining traffic.

## Configuring

In the web UI, the QoS service is configured under *QoS Services ---> Basic Config*.



## Using the Web UI

**Example:** Prioritize traffic with a particular ether-type above all other traffic

This example will create a QoS policy that uses a classifier to prioritize GOOSE messages above all others.

First, navigate to *QoS Services* ---> *Basic Config*. Ensure that QoS is **Enabled**.

### QoS Service

The screenshot shows the 'QoS Service' configuration page with the 'Basic Config' tab selected. The 'General' section is expanded, showing 'Enabled' with a checked checkbox. Below it are 'Policy' and 'Classifier' submenus.

**Figure 3-211. Enabling QoS**

To create a classifier for GOOSE messages, click **Add** in the Classifier submenu. The **Configure Classifier Details** appears.

The screenshot shows the 'Configure Classifier Details' form. The 'Name\*' field contains the text 'Example'. There are 'Add' and 'Cancel' buttons at the bottom right.

**Figure 3-212. Naming a new classifier**

Give the new classifier a name and click the **Add** button. A menu bearing the classifier's name appears to configure it.

The screenshot shows the 'Classifier' configuration page. The 'Match Type' is set to 'Any'. Below it is a 'Match' table with one rule:

| Name   | Ethernet - Src Address - Address | Ethernet - Dst Address - Address | Ethernet - Vlan Priority - Priority | Ethernet - Vlan ID - ID |
|--------|----------------------------------|----------------------------------|-------------------------------------|-------------------------|
| Match1 |                                  |                                  |                                     |                         |

The 'Metric' field is set to '10'. There is a 'Finish' button at the bottom right.

**Figure 3-213. QoS classifier configuration**

The following options are available on the classifier menu.

- **Match Type** – *All, Any*.
  - **All** – Match *all* match rules if there is more than one match rule in the classifier.



- **Any** – Match *any* match rule if there is more than one match rule in the classifier.
- **Match** – The list of match rules that govern the classifier.
- **Metric** – 1-20. Classifiers with a lower metric value are evaluated first. This means that if traffic matches more than one classifier, the classifier with the lowest metric is the one that is applied.

Click the **Add** button under the **Match** submenu to add a match rule.

The screenshot shows a light blue dialog box titled "Configure Match Details". At the top left, there is a small circular icon with a dot. Below it, the text "Name\*" is followed by a text input field containing "Match1". In the bottom right corner, there are two buttons: "Add" (highlighted in blue) and "Cancel" (grey).

**Figure 3-214. Adding a new match rule**

First, give the new match rule a name and click the **Add** button.

The screenshot shows the "Configure Match Details" dialog box with the "Match Menu" expanded. It is divided into two sections: "IPv4" and "Ethernet". Under "IPv4", there are three unchecked checkboxes: "Protocol", "Src Address", and "Dst Address". Under "Ethernet", there are three unchecked checkboxes: "Ether Type", "Src Address", and "Dst Address". A "Choices\*" dropdown menu is located below the "Tos Dscp" label. At the bottom right, there is a blue "Finish" button.

**Figure 3-215. Match Menu**

A match rule can be created to classify on either IPv4 or Ethernet. In this example, we use ether type to classify GOOSE messages.

To classify based on ether type, click the check box to the left of **Ether Type**.

The screenshot shows the "Ethernet" section of the "Configure Match Details" dialog box. The "Ether Type" checkbox is checked. Below it, there are two unchecked checkboxes: "Not" and "Type". A "Choices\*" dropdown menu is located below the "Type" label. Below that, there is a "Protocol" label followed by a dropdown menu showing "Goose".

**Figure 3-216. Ether type classification menu**

The following options are available on the **Ether Type** menu.

- **Not** – This menu is used to create a rule that matches packets that do *not* match a specific ether-type.
- **Type** – Protocol, Custom.
  - **Protocol** – Any, Arp, Goose, Gse, Ieee1588, IPv4, IPv6, Ipx, Mpls-multicast, Mpls-unicast, Pppoe-discovery, Pppoe-session, Profinet, Provider-bridging, Q-in-q, Rarp, Vlan.



- **Custom** – Enter the ether-type value directly, as either an unsigned 16-bit integer, or an unsigned 16-bit integer in hexadecimal format.

To specify GOOSE messages, click the **Type** dropdown box and select Protocol. Next, select Goose from the **Protocol** drop-down box. **Save** the configuration.

We must now create a QoS policy that applies this classifier. Return to the *QoS Services ---> Basic Config* menu and click the **Add** button in the **Policy** submenu.

**Configure Policy Details**

Name\*

**Figure 3-217. Naming a new QoS policy**

First, give the new policy a name and click the **Add** button.

**Configure Policy Details**

Type

**Figure 3-218. Specifying the type of QoS policy**

The **Type** dropdown contains the following options.

- **Prioritization** - The policy will implement a priority scheduler. Higher priority packets will always be serviced first. If there is excessive high priority traffic, lower priority packets may be lost.
- **Fairness** – A fairness policy attempts to split up the traffic into different groups, which it services in a round robin fashion to ensure one traffic flow does not prevent others from using the link. A fairness policy determines traffic flows on its own and does not need the user to set up classifiers for it.
- **Shaping-htb** – The shaping-htb policy sets up minimal and maximal data rates for classes of traffic. Classifiers must be set up to identify traffic and the classifiers are used to assign that class of traffic to one of the shaping policies. The shaping policy sets a guaranteed minimum data rate for each class and optionally a maximum data rate that the class cannot exceed.

Since this example prioritizes GOOSE messages above all other traffic, select Prioritization.

**Configure Policy Details**

Type

Default Priority\*

**Class**

| Name         | Priority | Next Policy |
|--------------|----------|-------------|
| HighPriority | 1        |             |

Showing 1 to 1 of 1

**Figure 3-219. QoS Prioritization menu**



Prioritization is based on priority classes that categorize packets based on QoS classifiers. Each class assigns a priority to packets that match the classifier. Create up to eight priority classes per policy.

The **Default** priority will be applied to all packets that do not match any priority class in the policy. The value can be a number from 1-16, where 1 is the highest priority and 16 is the lowest. For this example, we choose 1.

Click the **Add** button in the class submenu to create a new priority class. The **Configure Class Details** appears.

**Figure 3-220. Naming a new QoS priority class**

Enter a name for the priority class and click **Add**. A menu bearing the policy's name appears.

**Figure 3-221. Configuring a QoS priority class**

The following options are configurable:

- **Priority** – 1-16. This is the priority to be assigned to packets that match the classifier. 1 is the highest priority and 16 is the lowest.
- **Classifier** – Any existing QoS classifier.
- **Next policy** – If a QoS fairness policy was created, it may be applied it to this priority class. In this case, traffic matching this priority class' classifier will also be governed by a fairness scheme, where traffic sent from a single IP address or protocol will not monopolize the entire link.

Select the name of the classifier that was created for this example from the **Classifier** dropdown box. This incorporates the classifier, which selects all GOOSE messages, into the new priority class. Since this example makes GOOSE messages the highest priority, enter 1 as the priority. Click **Save**. The configured QoS classifiers and policies are listed at *QoS Services ---> Basic Config*.



## QoS Service ↻

Status Basic Config Advanced Config Actions

General

Enabled

Policy

Policy

Search  x Add ... Delete

| Name    |
|---------|
| Policy1 |

Showing 1 to 1 of 1

Classifier

Classifier

Search  x Add ... Delete

| Name    | Match Type | Metric |
|---------|------------|--------|
| Example | any        | 10     |

Showing 1 to 1 of 1

Figure 3-222. QoS menu

This policy has to be applied to an interface before it has any effect. Navigate to *Interfaces* and click on the desired interface. Click on the **QoS** dropdown from the *Basic Config* tab and select the new QoS policy to apply it to all traffic leaving that interface. Once configuration is complete, click **Save**.

## ETH1 Interface ↻

Status Basic Config Advanced Config Actions

General

IPv4

Filter

Nat

QoS

QoS

Output

Figure 3-223. Applying a QoS policy to an interface

## Using the CLI

### Example: Prioritize traffic with a particular ether-type above all other traffic

This example will create a QoS policy that uses a classifier to prioritize GOOSE messages above all others.

First, ensure that QoS is enabled.

```
% set services qos enabled true
```

To set up the classifier:

```
% set services qos classifier GOOSE match M1 ethernet ether-type protocol goose
```

To set up the policy:

```
% set services qos policy Policy1 prioritization default-priority 5
% set services qos policy Policy1 prioritization class HIGH priority 1 classifier GOOSE
% set services qos policy Policy1 prioritization class STANDARD priority 5
```





This will set up a policy that prioritizes all traffic with the ether-type of 0x88b8 above all else. Showing the config should display:

```
% show services qos
enabled true;
policy Policy1 {
  prioritization {
    default-priority 5;
    class HIGH {
      priority 1;
      classifier [ GOOSE ];
    }
    class STANDARD {
      priority 5;
    }
  }
}
classifier GOOSE {
  match M1 {
    ethernet {
      ether-type {
        protocol goose;
      }
    }
  }
}
```

This policy has to be applied to an interface before it has any affect. To apply the policy to an interface:

```
% set interfaces interface NxRadio qos output Policy1
```

Now all traffic going out of interface NxRadio will prioritize based on Policy1.

### Example: Priority Inversion

Suppose all traffic from IP address 1.2.3.4 needs to be prioritized above all else, unless it is SFTP traffic. SFTP traffic from anyone has to be prioritized at the lowest priority. To start with we will set up the classifiers and the policies.

```
% set services qos classifier SFTP match M1 ipv4 protocol assigned-number tcp
% set services qos classifier SFTP match M1 ipv4 dst-port services ssh
% set services qos classifier FROM1234 match M1 ipv4 src-address address 1.2.3.4/32
% set services qos policy Policy1 prioritization class HIGH priority 1 classifier FROM1234
% set services qos policy Policy1 prioritization class BULK priority 15 classifier SFTP
% set services qos policy Policy1 prioritization default-priority 5
```

This creates a policy with three classes where unclassified traffic will go into the second priority class. The class priority numbers do not imply the number of underlying classes, just the order of the classes' priority. The default priority can be the same as a defined class, but if it's not a class is created under the hood with no classifier or next policy.

The problem with this configuration is that because we check for matches in order of priority we will match on the IP address of 1.2.3.4 and apply the mark for the high priority class before we check if it is SFTP. One solution to this is to use the classifiers metric. A classifier with a lower metric is evaluated before classifiers with higher metrics. All classifiers have a default metric of 10. So by giving SFTP classifier a lower metric, it will be considered before the FROM1234 classifier.



```
% set services qos classifier SFTP metric 5
```

The other way to solve the problem would be to use the not syntax and explicitly prevent the FROM1234 classifier from matching SFTP traffic.

```
% set services qos classifier FROM1234 match M1 ipv4 protocol not assigned-number tcp
% set services qos classifier FROM1234 match M2 ipv4 src-address address 1.2.3.4/32
% set services qos classifier FROM1234 match M2 ipv4 protocol assigned-number tcp
% set services qos classifier FROM1234 match M2 ipv4 dst-port services ssh not
```

This will make the FROM1234 classifier:

```
% show services qos classifier FROM1234
match-type any;
match M1 {
  ipv4 {
    protocol {
      not;
      assigned-number tcp;
    }
    src-address {
      address 1.2.3.4/32;
    }
  }
}
match M2 {
  ipv4 {
    protocol {
      assigned-number tcp;
    }
    src-address {
      address 1.2.3.4/32;
    }
    dst-port {
      not;
      services [ ssh ];
    }
  }
}
```

This will make the classifier match everything from 1.2.3.4 that is not TCP and everything from 1.2.3.4 that is TCP and port is not SFTP. The coupling of ports to IP protocols complicates negating ports. Either constricting higher priority rules with the not syntax or inverting the order classification is evaluated with metric will work.

### Example: Fairness

Taking the last example if we wanted to extend it so that all traffic from 1.2.3.4 is evaluated fairly, we could apply a next policy to that class.

```
% set services qos policy FAIR fairness sfq
% set services qos policy Policy1 prioritization class HIGH next-policy FAIR
```

Now multiple traffic flows from 1.2.3.4 will be treated fairly.



## Example: shaping-htb

This example shows how to set up a shaping-htb policy, named *HTB*, with three classes of traffic: *GOOSE*, *VIDEO*, and *OTHER*. The policy is applied to the NxRadio interface after it's been determined that the max over-the-air egress data rate is 800Kbyte/s for this fielded unit. The GOOSE traffic is given high priority so that it is always handled before the other classes. It is given a committed, minimal, data rate of 100Kbyte/s so that it always has bandwidth to send GOOSE traffic and it can use up to 800Kbyte/s when there is no traffic in the other classes. Note that if no maximum rate is specified it is automatically set to the same rate as the committed rate. VIDEO class is given a committed rate of 200Kbyte/s but cannot exceed 400Kbyte/s even if there is no traffic in the other classes. This is done to ensure that the VIDEO stream will never saturate the link. Lastly, the default class OTHER is for any traffic that is not part of GOOSE or VIDEO classes. It has a committed rate of 500Kbyte/s and can use the entire 800Kbyte/s bandwidth if there is no traffic in the classes.

```
% set services qos classifier GOOSE match M1 ethernet ether-type protocol vlan
% set services qos classifier GOOSE match M1 ethernet encap-protocol protocol goose
% set services qos classifier VIDEO match M1 ipv4 protocol assigned-number tcp
% set services qos classifier VIDEO match M1 ipv4 dst-port port-range 8080

% set services qos policy HTB shaping-htb class GOOSE priority 0 committed-rate 100 max-
rate 800 classifier [ GOOSE ]
% set services qos policy HTB shaping-htb class VIDEO priority 1 committed-rate 200 max-rate
400 classifier [ VIDEO ]
% set services qos policy HTB shaping-htb class OTHER priority 16 committed-rate 500 max-
rate 800
% set services qos policy HTB shaping-htb committed-rate 800 max-rate 800 default-class
OTHER
% set services qos enabled true
% commit

% set interfaces interface NxRadio qos output HTB
commit
```

## Example: modify fields in an IP packet before they egress an interface

This example The following assumes the cellular interface has an IP address of 3.0.0.9. When ingress traffic is destined for 192.168.2.10, the DSCP value of those packets will be set to 16. A route is set up to forward all traffic matching the 192.168.2.0/24 address range through the GRE tunnel. However, only traffic matching destination address 192.168.2.10 will be modified.

```
% set interfaces interface GRE type gre
% set interfaces interface GRE gre-config mode ip-over-gre
% set interfaces interface GRE gre-config src-address 3.0.0.9
% set interfaces interface GRE gre-config dst-address 3.0.0.10
% set interfaces interface GRE filter input IN_TRUSTED
% set interfaces interface GRE filter output OUT_TRUSTED
% commit

% set services qos classifier DST-IP match 1 ipv4 dst-address address 192.168.2.10/32
% set services qos policy DSCP-POLICY modify dscp value 16
% commit

% set routing static-routes ipv4 route 1 outgoing-interface GRE
% set routing static-routes ipv4 route 1 dest-prefix 192.168.2.0/24
% commit
```



## Monitoring

At this time there are no commands to monitor traffic statistics for packets being scheduled by the QoS service. This feature may be added to future revisions of firmware.

### 3.8.18 SNMP

#### Understanding

MCR Orbit platform incorporates a SNMP agent to enable monitoring of system and network interface status with GE MDS PulseNET or other SNMP Managers. The SNMP agent on the Orbit platform provides following functionality:

- SNMP version v1, v2c and v3. Each of these versions can be enabled or disabled independently.
  - Ability to bind to a specific UDP port and one or more IPv4/v6 addresses (selected from the list of addresses assigned to various interfaces in the system). This allows the user to restrict SNMP service to specific network segments (for example, management VLAN).
- SNMPv3 security configuration
  - User Security Model (USM) - Ability to configure user authentication (md5 or sha1) and encryption (DES or AES).
  - View based Access Control Module (VACM) - Ability to configure VACM groups and views.
- SNMP traps/informs
  - The agent supports v1 traps, v2c/v3 traps and informs.
  - Ability to configure a list of SNMP targets (managers) that shall receive traps and informs. The unit sends SNMP traps/informs to the configured SNMP targets (managers) when events are logged (and if the SNMP notification has been enabled for those events).
- Standard MIBs supported
  - SNMPv2-MIB (RFC 3418)
  - SNMP-COMMUNITY-MIB (RFC 3584)
  - SNMP-USER-BASED-SM-MIB (RFC 3414)
  - SNMP-VIEW-BASED-ACM-MIB (RFC 3415)
  - SNMP-TARGET-MIB and SNMP-NOTIFICATION-MIB (RFC 3413)
  - IANAifType-MIB.mib
  - IF-MIB.mib (only ifTable and ifXtable are supported from this MIB). This is the interfaces group from MIB-II (RFC 2863).
- GE MDS specific MIBs supported
  - MDS-REG-MIB.mib - Top level GE MDS products' MIB.
  - MDS-ORBIT-SMI-MIB.mib - Top level GE MDS MIB for ORBIT platform.
  - MDS-EVENT-MIB.mib - GE MDS MIB for ORBIT events.
  - MDS-SYSTEM-MIB.mib - GE MDS MIB for ORBIT system status.
  - MDS-SERVICES-MIB.mib - GE MDS MIB for ORBIT services status.
  - MDS-SERIAL-MIB.mib - GE MDS MIB for ORBIT terminal server status.
  - MDS-IF-CELL-MIB.mib - GE MDS MIB for ORBIT Cellular interface status.
  - MDS-IF-IEEE80211-MIB.mib - GE MDS MIB for ORBIT Wi-Fi interface status.
  - MDS-IF-NX-MIB.mib - GE MDS MIB for ORBIT NX915 interface status.
  - MDS-IF-LN-MIB.mib - GE MDS MIB for ORBIT LNxxx interface status.



## Configuring

SNMP service configuration items can be divided up into the following categories related to SNMP

**Table 3-21. SNMP Categories**

|           |                                                      |
|-----------|------------------------------------------------------|
| agent     | Configuration of the SNMP agent                      |
| community | List of communities                                  |
| notify    | List of notify names and tags                        |
| system    | System group configuration                           |
| target    | List of targets for notifications (traps/informs)    |
| usm       | Configuration of the User-based Security Model       |
| vacm      | Configuration of the View-based Access Control Model |

In the Web UI these are provided on the screen by Navigating to: *SNMP Agent* ---> *Advanced Config.*



# SNMP Agent ↻

Status Basic Config **Advanced Config** Actions

Community

Community

Search  x Add ... Delete ⌵ ↻ 🔍 ✎

| Index  | Name | Sec Name | Target Tag |
|--------|------|----------|------------|
| public |      | public   |            |

Showing 1 to 1 of 1

USM Local

User

Search  x Add ... Delete ⌵ ↻ 🔍 ✎

| Name | Security Name |
|------|---------------|
|------|---------------|

Table is empty

USM Remote

Remote

Search  x Add ... Delete ⌵ ↻ 🔍 ✎

| Engine ID |
|-----------|
|-----------|

Table is empty

VACM

Group

Search  x Add ... Delete ⌵ ↻ 🔍 ✎

Name

all-rights

Showing 1 to 1 of 1

View

Search  x Add ... Delete ⌵ ↻ 🔍 ✎

Name

internet

Showing 1 to 1 of 1

Notify

Notify

Search  x ⌵ ↻ 🔍 ✎

| Name          | Tag           | Type   |
|---------------|---------------|--------|
| std_v1_trap   | std_v1_trap   | trap   |
| std_v2_inform | std_v2_inform | inform |
| std_v2_trap   | std_v2_trap   | trap   |
| std_v3_inform | std_v3_inform | inform |
| std_v3_trap   | std_v3_trap   | trap   |

Showing 1 to 5 of 5

Target

Target

Search  x Add ... Delete ⌵ ↻ 🔍 ✎

| Name | IP | Port | Timeout | Retries | Engine ID |
|------|----|------|---------|---------|-----------|
|------|----|------|---------|---------|-----------|

Table is empty

Figure 3-224. SNMP Main Page



## NOTES:

1. The sections below describe SNMP configuration in terms of use cases and do not attempt to list every available configuration parameter. The user should refer to the UI of the latest firmware version running on the unit to look at all available parameters.
2. The examples shown below use SNMP manager command line tools (provided by NET-SNMP package) running on a PC connected to LAN port of Orbit.

## Default Configuration

The unit as shipped (with factory defaults) has the SNMP agent enabled with version v2c, listening on port 161 and configured with a community string of “public”, a VACM group named “all-rights” that allows access to all SNMP parameters supported by the unit. This allows the user to start monitoring the unit via SNMP v2c without needing any additional configuration.

The example below shows how to do an SNMP walk using “snmpwalk” tool (from NET-SNMP package):

1. Unzip the provided MIB package into r current folder. For example, for ORBIT MCR product the MIB package is named “mcr-mib-X\_Y\_Z.zip”, where X.Y.Z is the corresponding firmware version.
2. Use “snmpwalk” tool to do SNMP walk on the unit (only small subset of output is shown for the sake of brevity)

```
$ snmpwalk -M +/ -c public -v2c 192.168.1.1 internet
SNMPv2-MIB::sysDescr.0 = STRING: GE MDS Orbit SNMP Agent
SNMPv2-MIB::sysObjectID.0 = OID: MDS-ORBIT-SMI-MIB::mdsOrbit
DISMAN-EVENT-MIB::sysUpTimeInstance = Timeticks: (14841) 0:02:28.41
SNMPv2-MIB::sysContact.0 = STRING:
SNMPv2-MIB::sysName.0 = STRING:
SNMPv2-MIB::sysLocation.0 = STRING:
SNMPv2-MIB::sysServices.0 = INTEGER: 72
SNMPv2-MIB::sysORLastChange.0 = Timeticks: (0) 0:00:00.00
```

## Configuring the SNMP agent for v1 and v2c operation

Although, the unit ships with default configuration that has SNMP agent enabled, in this section we show how to enable an SNMP agent with v1 and v2c from scratch. This example will help in understanding the different parts of SNMP configuration. Ensure the CLI is in Configuration mode.

1. Enable agent with v1 and v2c, on port 161 and engine-id generated from system’s MAC address.  
On the Web UI, click on the Agent from the SNMP main screen and set/verify the parameters:



## SNMP Agent

Status Basic Config Advanced Config Actions

Registration

Agent

- Enabled
- IPv4 Bind Ips
- IPv6 Bind Ips
- Port
- Max Message Size
- Debug Enabled

Agent Version

- V 1
- V 2c
- V 3

Agent Engine ID

Enterprise Number\*  Method

Choices\*

- From Mac
- Generate the SNMP engine ID based on the ether...

Figure 3-225. SNMP Agent Settings

- Agent settings:
  - **Enabled** – If checked (true) , the SNMP support is available.
  - **Ipv 4 Bind Ips** – Restrict the server to only listen for connections on the specified IPv4 addresses. If not specified, the server will listen on all IPv4 addresses.
  - **Ipv 6 Bind Ips** – Restrict the server to only listen for connections on the specified IPv6 addresses. If not specified, the server will listen on all IPv6 addresses.
  - **Port** – UDP protocol port to be used for communication Valid values: 0—65535 Default: 161
  - **Max Message Size** – The privacy mode to use on this interface.
  - **Debug Enabled** – The privacy mode to use on this interface
- Agent Version settings:
  - **V 1** – SNMP version 1: Only requires a plain-text community, with 32 bit counters, and minimal security.
  - **V 2C** – SNMP version 2 C (DEFAULT) : V 2c is basically equivalent to version 1, except it adds support for 64 bit counters.
  - **V 3** - SNMP version 3: adds both encryption and authentication, which can be used or in combination.
- Agent Engine settings:
  - **Engine ID** (submenu) - Local SNMP engine's administratively-unique identifier. Click on the Engine ID and set/verify the parameters.





### Engine ID settings:

- **Enterprise Number** – This value may be left at default and is an administratively unique identifier for the SNMPv3 engine. Combined with value from the selected method below is used to create the Engine ID which is used in SNMPv3 to generate authentication and encryption keys. DEFAULT: 4130
- **Method:**
  - From IP – Generate the SNMP engine ID based on the specified IP address
  - From Mac (DEFAULT) – Generate the SNMP engine ID based on the ethernet MAC address
  - From Text – Generate the SNMP engine ID based specified text string 1 to 27 letters.
  - Other – Generate the SNMP engine ID based specified hex string

Filling in the parameter values can be accomplished via the CLI using the following commands:

```
% set services snmp agent enabled true
% set services snmp agent port 161
% set services snmp agent version v1
% set services snmp agent version v2c
% set services snmp agent engine-id from-mac
```

1. Create SNMP community named “public” with security name “public”.

On the Web UI, click on the community panel under advanced config tab on SNMP Agent main screen and set/verify the parameters:

| Index  | Name | Sec Name | Target Tag |
|--------|------|----------|------------|
| public |      | public   |            |

Filling in the parameter values can be accomplished via the CLI using the following commands:

```
% set services snmp community public sec-name public
```

2. Create VACM group named “all-rights” and a view named “internet”

The VACM determines whether a SNMP request that has been authenticated by matching community security name (in case of SNMP v1/v2c) or by USM (in case SNMP v3) is authorized to access the MIB object that is contained in the request.

VACM view: A VACM view is a MIB view that includes an OID subtree value and a type that determines if the OID subtree is included or excluded from the view. For example in the case below, the view name is “internet” with subtree OID value of 1.3.6.1 and type “included”. This view basically includes all OIDs at or below 1.3.6.1 OID subtree.



On the Web UI, on the SNMP main screen scroll down to the bottom and click on **VACM** and set/verify the parameters. These parameters are nested and an example shown below:

- **Type:** Choices: (click on the box or select from the choices pulldown)
  - Included (DEFAULT) – The family of subtrees is included in the MIB view
  - Excluded – The family of subtrees is excluded in the MIB view

Filling in the VACM View parameter values can be accomplished via the CLI using the following commands:

```
% set services snmp vacm view internet subtree 1.3.6.1 included
```

- **VACM group** - A VACM group is used to organize a set of users (in case of SNMP v3) or a set of community security names (in case of SNMP v1 and v2c) for the purpose of managing their access rights to MIB parameters (OIDs). For example in the case below, the group name is “all-rights” with one member whose security name is “public” (as defined in snmp community configuration earlier) and whose “security model “ is v1 and v2c. In addition, the “all-rights” group has access to “internet” view under “any” security model and “no-auth-no-priv” security level. That is, the members of “all-rights” group can access internet view without any authentication (auth) or encryption (priv).



On the Web UI, on the SNMP main screen scroll down on each section and set/verify the parameters. These parameters are nested as shown in the example below:

Click on **all-rights** to see member and access definitions:

**Group**

Search [x] Add ... Delete [Signal] [Refresh] [Search] [Edit]

**Name**

all-rights

Showing 1 to 1 of 1

**Configure Group Details**

**Member**

Search [x] Add ... Delete [Signal] [Refresh] [Search] [Edit]

**Sec Name**

public

remote

Showing 1 to 2 of 2

**Access**

Search [x] Add ... Delete [Signal] [Refresh] [Search] [Edit]

| Sec Model | Sec Level       | Read View | Write View | Notify View |
|-----------|-----------------|-----------|------------|-------------|
| any       | no-auth-no-priv | internet  | internet   | internet    |

Showing 1 to 1 of 1

Finish

Filling in the VACM Group parameter values can be accomplished via the CLI using the following commands:

```
% set services snmp vacm group all-rights member public sec-model [v1 v2c ]
```

```
% set services snmp vacm group all-rights access any no-auth-no-priv read-view internet
```

3. Click “Save” on the Web UI.

Via the CLI using the following commands:

```
% commit
```

## Configuring the SNMP agent for v3-only operation (w/ Authentication and Encryption)

The example below assumes SNMP agent has factory default configuration (see section “Default Configuration on Page 303”).

1. Disable v2c and enable v3



## SNMP Agent

Status Basic Config **Advanced Config** Actions

Registration

Agent

- Enabled
- IPv4 Bind Ips
- IPv6 Bind Ips
- Port
- Max Message Size
- Debug Enabled

Agent Version

- V 1
- V 2c
- V 3

Agent Engine ID

Enterprise Number\*  Method

Choices\*

- From Mac
- Generate the SNMP engine ID based on the ether...

Setting the SNMP configuration can be accomplished via the CLI using the following commands:

- % delete services snmp agent version v1
- % delete services snmp agent version v2c
- % set services snmp agent version v3

2. Create a local user named “User1” with SHA1 authentication with password “sha1Password” and AES encryption with password “aesPassword”.

## SNMP Agent

Status Basic Config **Advanced Config** Actions

Community

USM Local

User

Search  Add ... Delete

| Name           | Security Name |
|----------------|---------------|
| Table is empty |               |

Configure User Details

Name\*

Add Cancel

Click on the **Add** button in the User table and then enter “User 1”. Once done, click the **Add** button. This will then prompt the user for additional information.



## Configure User Details

Auth

Priv

Finish

- Security Name – If not set, it is the same as the username.
- Auth – The parameters to configure message authentication.
- Priv - The parameters to configure messages encryption.

When the checkbox next to **Auth** is clicked, the following choices will appear for configuration.

Auth  
Protocol

Choices

Md 5

Sha

- **Choices** (select from the pulldown)
  - Sha (DEFAULT) – "secure hash algorithm" (SHA-1) - a cryptographic hash function producing a 160-bit (20-byte) hash value
  - Md5 – "message digest 5" - cryptographic hash function producing a 128-bit (16-byte) hash value

Sha  
Key Type

Choices

- **SHA Key Type:** Choices: (select from the choices pulldown)
  - Password (DEFAULT) – Used to create a localized key.
  - Key – 20-byte Authentication key

Md 5  
Key Type

Choices

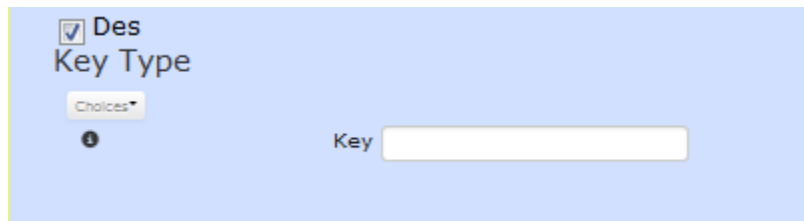
- **MD5 Key Type:** Choices: (select from the choices pulldown)
  - Password (DEFAULT) – Used to create a localized key.
  - Key – 16-byte Authentication key



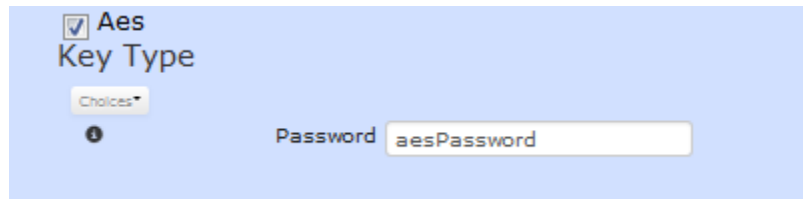
When the checkbox next to **Priv** is selected, the following will appear;



- **Choices** (select from the pulldown)
  - DES – Data Encryption Standard
  - AES – Advanced Encryption Standard.



- **Des Key Type: Choices:** (select from the choices pulldown)
  - Password (DEFAULT) – Used to create a localized key.
  - Key – 20-byte Authentication key



- **Aes Key Type: Choices:** (select from the choices pulldown)
  - Password (DEFAULT) – Used to create a localized key.
  - Key – 20-byte Authentication key

Filling in the User1 information values can be accomplished via the CLI using the following commands:

```
% set services snmp usm local user User1 auth sha password sha1Password  
% set services snmp usm local user User1 priv aes password aesPassword
```

3. Create VACM group named “secure” and add “User1” to this group with security model “usm”. Also, ensure group “secure” has read and notify access to “internet” view under “usm” security model and “auth-priv” security level. That is, the members of “secure” group can access internet view only with authentication (auth) or encryption (priv).



## SNMP Agent ↻

Status Basic Config **Advanced Config** Actions

- Community
- USM Local
- USM Remote
- VACM
  - Group**  
Search  x Add ... Delete ⌵ ↻ 🔍 ✎  
Name  
all-rights  
secure  
Showing 1 to 2 of 2
  - View**  
Search  x Add ... Delete ⌵ ↻ 🔍 ✎  
Name  
internet  
Showing 1 to 1 of 1

- Click on **Add...** and configure a name for the group. In this example, the group name will be “secure”.

## SNMP Agent ↻

Status Basic Config **Advanced Config** Actions

- Community
- USM Local
- USM Remote
- VACM
  - Group**  
Search  x Add ... Delete ⌵ ↻ 🔍 ✎  
Name  
all-rights  
Showing 1 to 1 of 1
  - Configure Group Details**  
ⓘ Name\*   
Add Cancel

- Once finished, click the **Add** button, which will present additional configurable fields.



**Configure Group Details**

**Member**

Search  x    Add ...    Delete    [Icons]

**Sec Name**

User1

Showing 1 to 1 of 1

**Access**

Search  x    Add ...    Delete    [Icons]

| Sec Model | Sec Level | Read View | Write View | Notify View |
|-----------|-----------|-----------|------------|-------------|
| usm       | auth-priv | internet  |            |             |

Showing 1 to 1 of 1

**Finish**

6. Assign a security model to User1 by clicking on the “User1” in the **Sec Name** table.

**Sec Name**

User1

Showing 1 to 1 of 1

**Configure Member Details**

Sec Model\*  x

**Finish**

- **Sec Model** - The security models under which this security Name (i.e. USM) is a member of this group.

7. Next, assign the “internet” SNMP view as the **Read View** of the “usm” Access Sec Model.

**Access**

Search  x    Add ...    Delete    [Icons]

| Sec Model | Sec Level | Read View | Write View | Notify View |
|-----------|-----------|-----------|------------|-------------|
| usm       | auth-priv | internet  |            |             |

Showing 1 to 1 of 1

**Configure Access Details**

Read View

Write View

Notify View

**Finish**

- **Read View** - The name of the MIB view of the SNMP context authorizing read access.
- **Write View** - The name of the MIB view of the SNMP context authorizing write access.
- **Notify View** - The name of the MIB view of the SNMP context authorizing notify access.

8. Filling in the VACM Group parameter values can be accomplished via the CLI using the following commands:

```
% set services snmp vacm group secure member User1 sec-model [usm]
% set services snmp vacm group secure access usm auth-priv read-view internet
```

9. Commit configuration





Click “Save” on the Web UI.

Via the CLI using the following commands:

```
% commit
```

The snmpwalk tool can be used test above configuration:

```
$ snmpwalk -M +./ -v3 -u User1 -a sha -A sha1Password -x aes -X aesPaasword -l authpriv  
192.168.1.1 internet  
SNMPv2-MIB::sysDescr.0 = STRING: GE MDS Orbit SNMP Agent  
SNMPv2-MIB::sysObjectID.0 = OID: MDS-ORBIT-SMI-MIB::mdsOrbit  
DISMAN-EVENT-MIB::sysUpTimeInstance = Timeticks: (6128338) 17:01:23.38  
SNMPv2-MIB::sysContact.0 = STRING:  
SNMPv2-MIB::sysName.0 = STRING:  
SNMPv2-MIB::sysLocation.0 = STRING:  
SNMPv2-MIB::sysServices.0 = INTEGER: 72  
SNMPv2-MIB::sysORLastChange.0 = Timeticks: (0) 0:00:00.00
```

## Configuring the SNMP agent to send notifications (traps/informs)

The SNMP notification table is preloaded with following entries:

| Name          | Tag           | Type   |
|---------------|---------------|--------|
| std_v1_trap   | std_v1_trap   | trap   |
| std_v2_inform | std_v2_inform | inform |
| std_v2_trap   | std_v2_trap   | trap   |
| std_v3_inform | std_v3_inform | inform |
| std_v3_trap   | std_v3_trap   | trap   |

Each entry above specifies a SNMP notify name (e.g. std\_v1\_trap), the tag (e.g. std\_v1\_trap) and the type of notification (trap or inform). The notify and tag names are kept the same for ease of configuration of SNMP targets. The SNMP notify name is used to lookup up the tag (in notify table) that in turns is used to look up all the SNMP targets (in target table) to which the SNMP notification needs to be sent.

Each event in the Orbit system can be configured to send an SNMP notification (trap/inform). By default, all events are configured to send SNMP notification with SNMP notify name of “” (empty string). This selects all tags in the notify table and attempts to lookup the targets that have been configured for these tags. The user can also configure the SNMP notify name to be used for each event.

### Sending all system events as SNMP v1 traps

Following example shows how to configure the unit to send v1 traps for all the events in the system to a specified SNMP target:

1. Ensure version v1 is enabled.



## SNMP Agent

Status Basic Config **Advanced Config** Actions

Registration

Agent

- Enabled
- IPv4 Bind Ips
- IPv6 Bind Ips
- Port
- Max Message Size
- Debug Enabled

Agent Version

- V 1
- V 2c
- V 3

Agent Engine ID

Enterprise Number\*  Method

Choices\*  From Mac  Generate the SNMP engine ID based on the ether...

Filling in values can be accomplished via the CLI using the following commands:

```
% set services snmp agent version v1
```

2. Configure SNMP manager as a target (“TARGET-1-v1”) that listens on port 5000, has IP address of 192.168.1.2, can receive v1 traps (tag “std\_v1\_trap”) with security name of “public”.

Target

Search  Add ... Delete

| Name        | IP          | Port | Timeout | Retries | Engine ID |
|-------------|-------------|------|---------|---------|-----------|
| TARGET-1-v1 | 192.168.1.2 | 5000 | 1500    | 3       |           |

Showing 1 to 1 of 1

Configure Target Details

- IP\*
- Port
- Tag
- Timeout
- Retries
- Engine ID

Params

Choices\* Sec Name\*

Finish



Filling in values can be accomplished via the CLI using the following commands:

```
% set services snmp target TARGET-1-v1 ip 192.168.1.2
% set services snmp target TARGET-1-v1 port 5000
% set services snmp target TARGET-1-v1 tag std_v1_trap
% set services snmp target TARGET-1-v1 v1 sec-name public
```

3. Give the VACM group named “all-rights” (as configured in previous examples) notify access to “internet” view.

**Group**

Search [x] Add ... Delete

Name

all-rights

secure

Showing 1 to 2 of 2

---

**Configure Group Details**

**Member**

Search [x] Add ... Delete

Sec Name

public

remote

Showing 1 to 2 of 2

**Access**

Search [x] Add ... Delete

| Sec Model | Sec Level       | Read View | Write View | Notify View |
|-----------|-----------------|-----------|------------|-------------|
| any       | no-auth-no-priv | internet  | internet   | internet    |

Showing 1 to 1 of 1

Finish

Filling in values can be accomplished via the CLI using the following commands:

```
% set services snmp vacm group all-rights access any no-auth-no-priv notify-view internet
```

4. Click “Save” on the Web UI.

Via the CLI using the following commands:

```
% commit
```

To test above configuration, start an SNMP trap receiver (like “snmptrapd” with configuration file as shown below) and generate “ssh\_login” event by logging into the Orbit via SSH.

```
snmptrapd.conf:
engineID testing
snmpTrapdAddr 0.0.0.0:5000
authCommunity log,execute,net public
doNotFork yes
$ snmptrapd -M +/ -Lo -c snmptrapd.conf
NET-SNMP version 5.4.3
```

```
2014-04-22 13:39:02 0.0.0.0(via UDP: [192.168.1.1]:161->[192.168.1.2]) TRAP, SNMP v1,
community public
MDS-EVENT-MIB::traps0 Enterprise Specific Trap (MDS-EVENT-MIB::mdsEvent) Uptime:
2:07:00.35
MDS-EVENT-MIB::mdsEventName.0 = STRING: "ssh_login"
```



```
MDS-EVENT-MIB::mdsEventInfoInCee.0 = STRING:
"@cee:{\"host\": \"(none)\", \"pname\": \"loggingmgr\", \"time\": \"2014-04-15T02:02:38.091753+00:00\", \"action\": \"login\", \"service\": \"ssh\", \"domain\": \"os\", \"object\": \"session\", \"status\": \"success\", \"src_ipv4\": \"192.168.1.2\", \"src_port\": 42135, \"user_name\": \"admin\", \"event\": \"ssh_login\", \"profile\": \"http://gemds.com/cee_profile/1.0beta1.xsd\"}"
```

As can be seen above, the SNMP agent sent a v1 trap for “ssh\_login” event

---

**NOTE** The following configuration are very similar to the WebUI Screens already presented. To save space only the CLI version is presented.

---

## Sending all system events as SNMP v2c traps

Following example shows how to configure the unit to send v2c traps for all the events in the system to a specified SNMP target via the CLI command line:

1. Ensure version v2c is enabled.  

```
% set services snmp agent version v2c
```
2. Configure SNMP manager as a target that listens on port 5000, has IP address of 192.168.1.2, can receive v2c traps (tag “std\_v2\_trap”) with security name of “public”.  

```
% set services snmp target TARGET-1-v2c ip 192.168.1.2
% set services snmp target TARGET-1-v2c port 5000
% set services snmp target TARGET-1-v2c tag std_v2_trap
% set services snmp target TARGET-1-v2c v2c sec-name public
```
3. Give the VACM group named “all-rights” (as configured in previous examples) notify access to “internet” view.  

```
% set services snmp vacm group all-rights access any no-auth-no-priv notify-view internet
```
4. Commit configuration.  

```
% commit
```

To test above configuration, start an SNMP trap receiver (like “snmptrapd” with configuration file as shown below) and generate “ssh\_login” event by logging into the Orbit via SSH.

```
snmptrapd.conf:
engineID testing
snmpTrapdAddr 0.0.0.0:5000
authCommunity log,execute,net public
doNotFork yes

$ snmptrapd -M +./ -Lo -c snmptrapd.conf
NET-SNMP version 5.4.3

192.168.1.1 [UDP: [192.168.1.1]:161->[192.168.1.2]]: Trap ,
DISMAN-EVENT-MIB::sysUpTimeInstance = Timeticks: (592863) 1:38:48.63,
SNMPv2-MIB::snmpTrapOID.0 = OID: MDS-EVENT-MIB::mdsEvent,
MDS-EVENT-MIB::mdsEventName.0 = STRING: "ssh_login",
MDS-EVENT-MIB::mdsEventInfoInCee.0 = STRING:
"@cee:{\"host\": \"(none)\", \"pname\": \"loggingmgr\", \"time\": \"2014-04-15T01:34:26.373312+00:00\", \"action\": \"login\", \"service\": \"ssh\", \"domain\": \"os\", \"object\": \"session\", \"status\": \"success\", \"src_ipv4\": \"192.168.1.2\", \"src_port\": 42031, \"user_name\": \"admin\", \"event\": \"ssh_login\", \"profile\": \"http://gemds.com/cee_profile/1.0beta1.xsd\"}"
```

As can be seen above, the SNMP agent sent a v2 trap for “ssh\_login” event.



## Sending all system events as SNMP v3 traps (w/ Authentication and Encryption)

Following example shows how to configure the unit to send v3 traps with authentication and encryption for all the events in the system to a specified SNMP target via the CLI command line:

1. Ensure version v3 is enabled.  

```
% set services snmp agent version v3
```
2. Configure SNMP manager as a target that listens on port 5000, has IP address of 192.168.1.2, can receive v3 traps (tag “std\_v3\_trap”) using user name “User1” (Please refer to the section on configuring SNMP v3-only to see how to configure local user “User1”).  

```
% set services snmp target TARGET-1-v3 ip 192.168.1.2
% set services snmp target TARGET-1-v3 port 5000
% set services snmp target TARGET-1-v3 tag std_v3_trap
% set services snmp target TARGET-1-v3 usm user-name User1
% set services snmp target TARGET-1-v3 usm sec-level auth-priv
```
3. Give the VACM group named “secure” (as configured in example on SNMP v3-only configuration) notify access to “internet” view.  

```
% set services snmp vacm group secure access usm auth-priv notify-view internet
```
4. Commit configuration.  

```
% commit
```

To test above configuration, start an SNMP trap receiver (like “snmptrapd” with configuration file as shown below) and generate “ssh\_login” event by logging into the Orbit via SSH.

---

**NOTE** When using SNMPv3 traps, the Orbit is the authoritative engine since it is the one sending the trap. Therefore, the user created in snmptrapd.conf must be tied to the EngineID of Orbit. The EngineID of Orbit can be obtained by running following command:

---

```
% run show SNMP-FRAMEWORK-MIB snmpEngine snmpEngineID
SNMP-FRAMEWORK-MIB snmpEngine snmpEngineID 80:00:10:22:03:00:06:3d:06:ea:96
snmptrapd.conf:
engineID testing
snmpTrapdAddr 0.0.0.0:5000
createUser -e 800010220300063d06ea96 User1 SHA shaPassword AES aesPassword
doNotFork yes
authUser log,execute,net User1
```

```
$ snmptrapd -M +./ -Lo -c snmptrapd.conf
NET-SNMP version 5.4.3
```

```
2014-04-22 13:59:13 192.168.1.1 [UDP: [192.168.1.1]:161->[192.168.1.2]]:
DISMAN-EVENT-MIB::sysUpTimeInstance = Timeticks: (883103) 2:27:11.03
SNMPv2-MIB::snmpTrapOID.0 = OID: MDS-EVENT-MIB::mdsEvent
MDS-EVENT-MIB::mdsEventName.0 = STRING: "ssh_login"
MDS-EVENT-MIB::mdsEventInfoInCee.0 = STRING:
"@cee:{\"host\": \"(none)\", \"pname\": \"loggingmgr\", \"time\": \"2014-04-15T02:22:48.771834+00:00\", \"action\": \"login\", \"service\": \"ssh\", \"domain\": \"os\", \"object\": \"session\", \"status\": \"success\", \"src_ipv4\": \"192.168.1.2\", \"src_port\": 42156, \"user_name\": \"admin\", \"event\": \"ssh_login\", \"profile\": \"http://gemds.com/cee_profile/1.0beta1.xsd\"}"
```

As can be seen above, the SNMP agent sent a v3 trap for “ssh\_login” event. If the authentication or encryption password for user “User1” as set in snmptrapd.conf file does not match as that configured in the unit, snmptrapd will not display the received trap.



## Sending all system events as SNMP v2c informs

An SNMP inform is an acknowledged trap. Following example shows how to configure the unit to send v2c informs for all the events in the system to a specified SNMP target:

1. Ensure version v2c is enabled.  

```
% set services snmp agent version v2c
```
2. Configure SNMP manager as a target that listens on port 5000, has IP address of 192.168.1.2, can receive v2c informs (tag “std\_v2\_inform”) with security name of “public”, with retry timeout of 15 seconds (timeout parameter is in units of 0.01 seconds) and max number of retries of 3.  

```
% set services snmp target TARGET-1-v2c ip 192.168.1.2
% set services snmp target TARGET-1-v2c port 5000
% set services snmp target TARGET-1-v2c tag std_v2_inform
% set services snmp target TARGET-1-v2c v2c sec-name public
% set services snmp target TARGET-1-v2c timeout 1500
% set services snmp target TARGET-1-v2c retries 3
```
3. Give the VACM group named “all-rights” (as configured in previous examples) notify access to “internet” view.  

```
% set services snmp vacm group all-rights access any no-auth-no-priv notify-view internet
```
4. Commit configuration.  

```
% commit
```

To test above configuration, start an SNMP trap receiver (like “snmptrapd” with configuration file as shown below) and generate “ssh\_login” event by logging into the Orbit via SSH.

**snmptrapd.conf:**

```
engineID testing
snmpTrapdAddr 0.0.0.0:5000
authCommunity log,execute,net public
doNotFork yes
```

```
$ snmptrapd -M +./ -Lo -c snmptrapd.conf
NET-SNMP version 5.4.3
```

```
2014-04-22 16:02:17 192.168.1.1 [UDP: [192.168.1.1]:161->[192.168.1.2]]:
DISMAN-EVENT-MIB::sysUpTimeInstance = Timeticks: (271741) 0:45:17.41
SNMPv2-MIB::snmpTrapOID.0 = OID: MDS-EVENT-MIB::mdsEvent
MDS-EVENT-MIB::mdsEventName.0 = STRING: "ssh_login"
MDS-EVENT-MIB::mdsEventInfoInCee.0 = STRING:
"@cee:{\"host\": \"(none)\", \"pname\": \"loggingmgr\", \"time\": \"2014-04-15T04:25:53.677885+00:00\", \"action\": \"login\", \"service\": \"ssh\", \"domain\": \"os\", \"object\": \"session\", \"status\": \"success\", \"src_ipv4\": \"192.168.1.2\", \"src_port\": 42694, \"user_name\": \"admin\", \"event\": \"ssh_login\", \"profile\": \"http://gemds.com/cee_profile/1.0beta1.xsd\"}"
```

## Sending all system events as SNMP v3 informs

Following example shows how to configure the unit to send v3 informs for all the events in the system to a specified SNMP target via the CLI command line:

1. Ensure version v3 is enabled.  

```
% set services snmp agent version v3
```
2. Create a remote user named “RemUser1” with engine-id of SNMP inform receiver (80:00:1f:88:04:74:65:73:74:69:6e:67) and SHA1 authentication with password “sha1Password” and AES encryption with password “aesPassword”.



**NOTE** When using SNMPv3 informs, the inform receiver is the authoritative engine.

```
% set services snmp usm remote 80:00:1f:88:04:74:65:73:74:69:6e:67 user RemUser1 auth
sha password sha1Password
```

```
% set services snmp usm remote 80:00:1f:88:04:74:65:73:74:69:6e:67 user RemUser1 priv aes
password aesPassword
```

3. Configure SNMP manager as a target with engine id 80:00:1f:88:04:74:65:73:74:69:6e:67 that listens on port 5000, has IP address of 192.168.1.2, can receive v3 informs (tag “std\_v3\_inform”) with user name of ”RemUser1”, with retry timeout of 15 seconds (timeout parameter is in units of 0.01 seconds) and max number of retries of 3.

```
% set services snmp target TARGET-1-v3 ip 192.168.1.2
```

```
% set services snmp target TARGET-1-v3 port 5000
```

```
% set services snmp target TARGET-1-v3 tag std_v3_inform
```

```
% set services snmp target TARGET-1-v3 timeout 1500
```

```
% set services snmp target TARGET-1-v3 retries 3
```

```
% set services snmp target TARGET-1-v3-inform engine-id 80:00:1f:88:04:74:65:73:74:69:6e:67
```

```
% set services snmp target TARGET-1-v3-inform usm user-name RemUser1
```

```
% set services snmp target TARGET-1-v3-inform usm sec-level auth-priv
```

4. Add “RemUser1” to VACM group “secure” (as configured in example on SNMP v3-only configuration) with security model “usm”. Also, ensure VACM group “secure” has notify access to “internet” view under “usm” security model and “auth-priv” security level.

```
% set services snmp vacm group secure member User1 sec-model [usm]
```

```
% set services snmp vacm group secure access usm auth-priv notify-view internet
```

5. Commit configuration.

```
% commit
```

To test above configuration, start an SNMP trap receiver (like “snmptrapd” with configuration file as shown below) and generate “ssh\_login” event by logging into the Orbit via SSH.

```
snmptrapd.conf:
engineID testing
snmpTrapdAddr 0.0.0.0:5000
createUser RemUser1 SHA sha1Password AES aesPassword
authUser log,execute,net RemUser1
doNotFork yes
```

```
$ snmptrapd -M +/ -Lo -c snmptrapd.conf
```

```
NET-SNMP version 5.4.3
```

```
2014-04-22 16:02:17 192.168.1.1 [UDP: [192.168.1.1]:161->[192.168.1.2]]:
```

```
DISMAN-EVENT-MIB::sysUpTimeInstance = Timeticks: (271741) 0:45:17.41
```

```
SNMPv2-MIB::snmpTrapOID.0 = OID: MDS-EVENT-MIB::mdsEvent
```

```
MDS-EVENT-MIB::mdsEventName.0 = STRING: "ssh_login"
```

```
MDS-EVENT-MIB::mdsEventInfoInCee.0 = STRING:
```

```
"@cee:{\"host\": \"(none)\", \"pname\": \"loggingmgr\", \"time\": \"2014-04-
15T04:25:53.677885+00:00\", \"action\": \"login\", \"service\": \"ssh\", \"domain\": \"os\", \"o
bject\": \"session\", \"status\": \"success\", \"src_ipv4\": \"192.168.1.2\", \"src_port\": 42694,
\"user_name\": \"admin\", \"event\": \"ssh_login\", \"profile\": \"http://gemds.com/cee_profil
e/1.0beta1.xsd\"}"
```

## Monitoring

Ensure the CLI is in operational mode. Check SNMP agent status

```
> show SNMPv2-MIB
```



```
SNMPv2-MIB system sysDescr "GE MDS Orbit SNMP Agent"  
SNMPv2-MIB system sysObjectID 1.3.6.1.4.1.4130.10  
SNMPv2-MIB system sysUpTime 911614  
SNMPv2-MIB system sysServices 72  
SNMPv2-MIB system sysORLastChange 0  
SNMPv2-MIB snmp snmplnPkts 0  
SNMPv2-MIB snmp snmplnBadVersions 0  
SNMPv2-MIB snmp snmplnBadCommunityNames 0  
SNMPv2-MIB snmp snmplnBadCommunityUses 0  
SNMPv2-MIB snmp snmplnASNParseErrs 0  
SNMPv2-MIB snmp snmpSilentDrops 0  
SNMPv2-MIB snmp snmpProxyDrops 0  
SNMPv2-MIB snmpSet snmpSetSerialNo 3928852  
  
> show SNMP-FRAMEWORK-MIB  
SNMP-FRAMEWORK-MIB snmpEngine snmpEngineID 80:00:10:22:03:00:06:3d:06:ea:96  
SNMP-FRAMEWORK-MIB snmpEngine snmpEngineBoots 36  
SNMP-FRAMEWORK-MIB snmpEngine snmpEngineTime 9151  
SNMP-FRAMEWORK-MIB snmpEngine snmpEngineMaxMessageSize 50000  
  
> show SNMP-USER-BASED-SM-MIB  
SNMP-USER-BASED-SM-MIB usmStats usmStatsUnsupportedSecLevels 0  
SNMP-USER-BASED-SM-MIB usmStats usmStatsNotInTimeWindows 0  
SNMP-USER-BASED-SM-MIB usmStats usmStatsUnknownUserNames 0  
SNMP-USER-BASED-SM-MIB usmStats usmStatsUnknownEngineIDs 0  
SNMP-USER-BASED-SM-MIB usmStats usmStatsWrongDigests 0  
SNMP-USER-BASED-SM-MIB usmStats usmStatsDecryptionErrors 0  
  
> show SNMP-MPD-MIB  
SNMP-MPD-MIB snmpMPDStats snmpUnknownSecurityModels 0  
SNMP-MPD-MIB snmpMPDStats snmpInvalidMsgs 0  
SNMP-MPD-MIB snmpMPDStats snmpUnknownPDUHandlers 0  
  
> show SNMP-TARGET-MIB  
SNMP-TARGET-MIB snmpTargetObjects snmpUnavailableContexts 0  
SNMP-TARGET-MIB snmpTargetObjects snmpUnknownContexts 0
```

### 3.8.19 Network Monitor Service

#### Understanding

Network monitor service allows the user to configure network monitor operations like interface-monitor or icmp-echo-monitor. These operations signal whether the operation state is up or down based on the state of the interface or periodic pinging of a remote host respectively. This signal can then be used by other applications to do interesting things. For example, routing uses the signal from interface-monitor or icmp-echo-monitor to add/remove routes that have been configured with verify-reachability check using that operation. This enables route failover/failback based on the state of the operation. Also, icmp-monitor-operation can also just be used to generate some periodic traffic towards a specific host.

#### Configuration

##### Using the WebUI

Following example shows how to configure icmp-echo-monitor operation for verifying that the link over NX is working.





Click 'Add' at *Netmon* --->*Basic Config / General* and create an operation with a descriptive name, say, NX-LINK-CHECK.

### Netmon Service [↻](#)

Status Basic Config Advanced Config Actions

General

#### Operation

Search  x Add ... Delete

| Name           | Enabled | Type | Interface Monitor - Interface | Interface Monitor - Down Delay | Interface Monitor - Up Delay | Icmp Echo Monitor - Dst Host |
|----------------|---------|------|-------------------------------|--------------------------------|------------------------------|------------------------------|
| Table is empty |         |      |                               |                                |                              |                              |

### Netmon Service [↻](#)

Status Basic Config Advanced Config Actions

General

#### Operation

Search  x Add ... Delete

| Name          | Enabled | Type              | Interface Monitor - Interface | Interface Monitor - Down Delay | Interface Monitor - Up Delay | Icmp Echo Monitor - Dst Host |
|---------------|---------|-------------------|-------------------------------|--------------------------------|------------------------------|------------------------------|
| NX-LINK-CHECK | true    | icmp-echo-monitor |                               |                                |                              | 192.168.1.4                  |

Showing 1 to 1 of 1

#### Configure Operation Details

Enabled

Type\*

Icmp Echo Monitor

Alternatives\*

Dst Host\*

Src Address

Interval

Timeout

Successive Loss Threshold

Successive Gain Threshold

Finish

The above configuration will indicate that the link is down (or up) if 6 successive pings fail (or succeed).

- **Enabled** - Whether or not to run this operation
- **Type** - Type of monitor operation
  - Icmp Echo Monitor
    - Dst Host - Destination IP address or DNS name to send icmp-echo to.
    - Src Address - Source address to use for icmp-echo request
    - Interval - Time interval (in seconds) between icmp-echo requests. Value range [1..86400] DEFAULT=5
    - Timeout - Time to wait (in milliseconds) for icmp-echo response. Value range [1..5000] DEFAULT=2000



- Successive Loss Threshold - Number of consecutive icmp-echo requests for which no responses need to be received before destination is declared unreachable. Value range [1..32] DEFAULT = 6
- Successive Gain Threshold - Number of consecutive icmp-echo requests for which no responses need to be received before destination is declared reachable. Value range [1..32] DEFAULT = 6

The interface-monitor operation can be created in a similar way.

### Using the CLI

```
% set services netmon operation NX-LINK-CHECK enabled true
% set services netmon operation NX-LINK-CHECK type icmp-echo-monitor
% set services netmon operation NX-LINK-CHECK icmp-echo-monitor dst-host 192.168.1.4
% set services netmon operation NX-LINK-CHECK icmp-echo-monitor interval 5
% set services netmon operation NX-LINK-CHECK icmp-echo-monitor timeout 1000
% set services netmon operation NX-LINK-CHECK icmp-echo-monitor successive-loss-threshold
6
% set services netmon operation NX-LINK-CHECK icmp-echo-monitor successive-gain-
threshold 6
```

### 3.8.20 Network Link Failover/Failback

#### Understanding

The unit incorporates integrated bridging and routing functionality with multiple wired and wireless interfaces. The reliability of network links can be enhanced using network link failover/failback features.

The unit supports following two types of network link failover and failback features:

**Route (Layer-3) Failover** - The unit supports this feature by enabling configuration of multiple routes to same destination network with different preference (metric) values, enabling traffic to be sent using the route with high preference in normal scenario and failing back to the route with lower preference when the destination network is not reachable through the higher preference route.

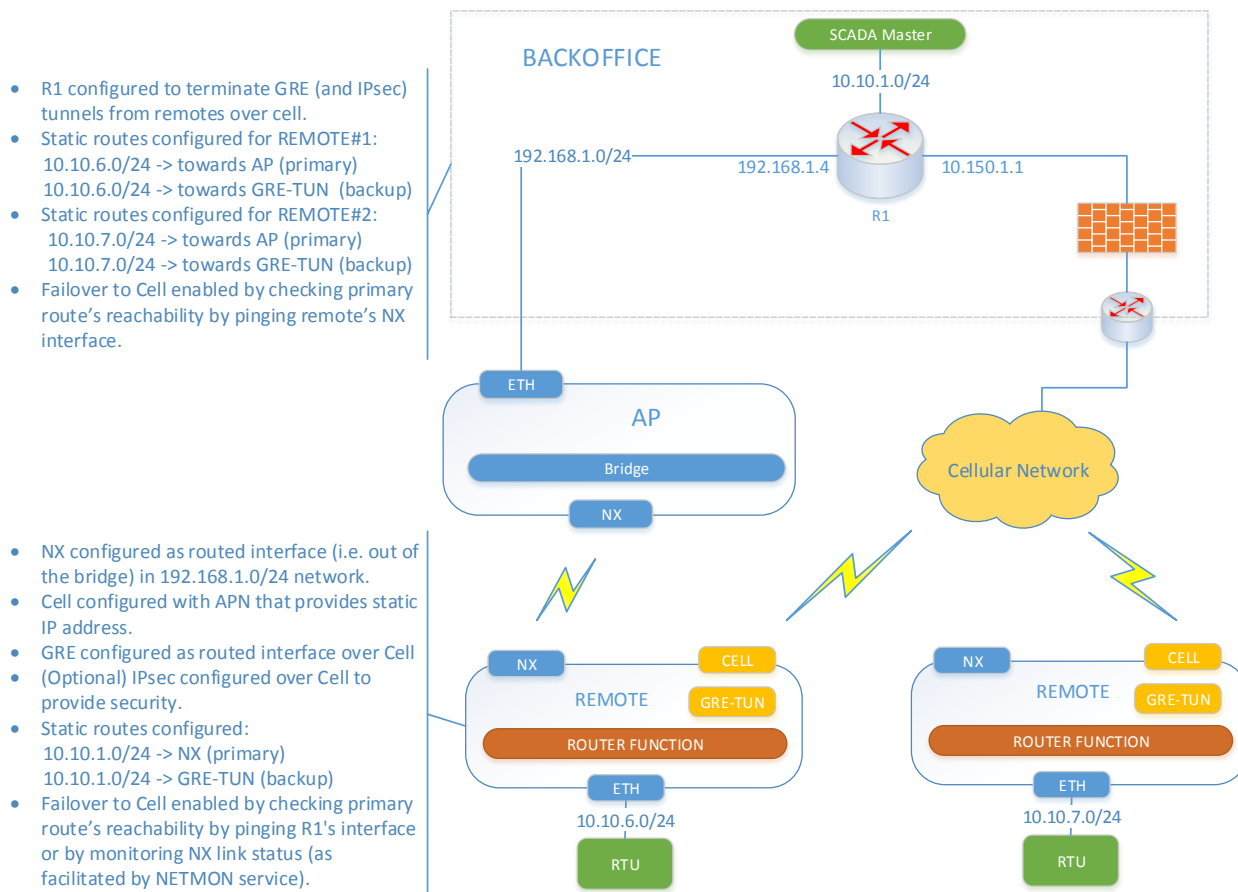
**Link (Layer-2) Failover** - The unit supports this feature by creation of a bond interface in an active-backup mode that can aggregate a primary and secondary layer-2 link. When primary link is down, the secondary link is used to send layer-2 traffic etc.

#### Use Case#1 High Reliability SCADA back office to Remote Sites Network

Following figure shows a setup to achieve a high reliability network communications between a SCADA back office and remote sites using 900 MHz and Cellular communications in a redundant network setup using routing functionality



### SCADA Back-office to Remote MCR NX+CELL redundant network setup using routing – Use Case#1



**Figure 3-226. SCADA Back-office to Remote MCR NX+CELL redundant setup using routing**

In above use case, the SCADA back-office application sends/receives data to/from a remote asset connected to remote MCR (called REMOTE hereafter) that has both 900 MHz radio (NX) and Cellular radio options. The IP packets sent by back-office application to the remote asset are normally routed by the back-office router (R1) towards MCR configured as the NX AP (called AP hereafter). The IP packets sent by remote asset to the back-office application are normally routed by the REMOTE towards the AP. Both R1 and REMOTE verify the primary link (NX) connectivity by sending periodic ICMP echo requests (pings). In the event that N (configurable) successive pings are lost, both R1 and REMOTE update their routing tables to direct traffic over cellular network instead. Both still keep checking the primary link connectivity. Once primary link connectivity is restored (i.e. N successful pings), both R1 and REMOTE update their routing tables to direct traffic back over NX network.

The above setup on remote MCR is facilitated by following functionality available on the unit:

1. Ability to configure multiple routes towards back-office network with different preference values. The primary route towards back-office network over NX is configured with lower preference value (lower the value more preferred the route) than secondary route towards back-office network over Cellular.
2. Ability to associate the primary route with verify-reachability operation, which checks the reachability of the back-office network via this route. The reachability check is done by configuring a NETMON service operation, which checks connectivity based on either the link status of the primary interface (NX) or on ICMP ECHO requests (pings) towards a host reachable via the



primary interface. If the reachability check determines that the network link is down, then that primary route is removed and, as a result, the traffic towards the back-office network now uses the secondary route (over Cell). If the reachability check determines that the network link is back up, the primary route is added back and, as a result, the traffic towards the back-office network now uses the primary route (over NX) again.

3. Ability to tunnel private customer traffic over public cellular network using GRE tunneling (IP-OVER-GRE mode) or GRE with IPsec tunneling, in case, end-to-end security is desired. The GRE tunnel provides a routed interface that can then be used as the outgoing interface in the secondary route.

## AP Configuration

In this use case, the AP is not involved in the failover and hence should be configured as usual with NX interface in AP mode.

## Router R1 Configuration

The R1 router in this case could be a routing appliance from Cisco or Juniper etc. Following features need to be configured on this device:

1. IPsec transport mode connection – To secure GRE traffic from back-office to the Remotes over Cellular network.
2. GRE tunnel – To route the traffic from back-office to the Remotes over Cellular network.
3. A network/link monitoring operation that checks connectivity to each remote over the primary interface and that enables primary route to be used when connectivity is up and secondary route to be used when connectivity is down.
4. Primary and secondary routes towards each Remote LAN network.

The user should refer to user manual of the specific device to configure these features.

## REMOTE#1 Configuration

Following features need to be configured on this device:

1. IPsec transport mode connection– To secure GRE traffic from local LAN segment to back-office over Cellular network.
2. GRE tunnel – To route the traffic from local LAN segment to back-office over Cellular network.
3. A network monitoring operation that checks connectivity to back-office network over the primary interface (i.e. NX) and that enables primary route to be used when connectivity is up and secondary route to be used when connectivity is down.
4. Primary and secondary routes towards the back-office network.

## Using the Web UI

### Configure IPsec Transport Mode Connection

1. Configure an IPsec VPN connection with host-to-host connection type. Please refer to section on VPN for help with configuring IPsec VPN using Web UI.

### Configure GRE tunnel

2. Configure GRE tunnel interface with mode = ip-over-gre, src-address = 10.150.1.10 (the local Cell interface address) and dst-address = 10.150.1.1 (the WAN address of the R1 router).
  - Navigate to **Interfaces / Add/Delete Interfaces** and click ‘Add’ to create new interface named ‘GRE1’:



Please select the Interface Type

Type\* Gre

Name: GRE1

OK Cancel

## GRE1 Interface

Status Basic Config Advanced Config

General

Description

Enabled

Gre

Gre Config

Mode\* ip-over-gre

Src Address\* 10.150.1.10

Dst Address\* 10.150.1.1

Key

Ttl 64

Vpn IPSEC Connection

### Configure Network Monitor Operation

3. Configure a NETMON service icmp-echo-monitor operation named NX-LINK-CHECK that does a periodic link check by pinging R1 over NX interface. Please refer to NETMON service section for further help with configuration.



## Netmon Service ↗

Status Basic Config Advanced Config Actions

General

### Operation

Search  Add ... Delete

| Name          | Enabled | Type              | Interface Monitor - Interface | Interface Monitor - Down Delay | Interface Monitor - Up Delay | Icmp Echo Monitor - Dst Host |
|---------------|---------|-------------------|-------------------------------|--------------------------------|------------------------------|------------------------------|
| NX-LINK-CHECK | true    | icmp-echo-monitor |                               |                                |                              | 192.168.4                    |

Showing 1 to 1 of 1

### Configure Operation Details

Enabled

Type\*

Icmp Echo Monitor

Alternatives\*

Dst Host\*

Src Address

Interval

Timeout

Successive Loss Threshold

Successive Gain Threshold

Finish

### Configure Primary and Secondary routes towards back-office network

5. Configure primary route towards SCADA back-office network (10.10.1.0/24) with NX as the outgoing interface and with address of R1's interface on NX backhaul as the next-hop. Also, configure this route with verify-reachability using NX-LINK-CHECK operation, which checks the reachability of the back-office network via this route.
  - Navigate to **Routing ---> Basic Config / IPv4** and click 'Add' to add the primary route over NX:



## Routing ↻

Status Basic Config **Advanced Config** Actions

IPv4

### Route

Search  Add ... Delete Move ▾

| ID | Description | Outgoing Interface | Preference | Verify Reachability - Operation | Dest Prefix  | Next Hop    |
|----|-------------|--------------------|------------|---------------------------------|--------------|-------------|
| 1  |             | NxRadio            |            | NX-LINK-CHECK                   | 10.10.1.0/24 | 192.168.1.4 |

Showing 1 to 1 of 1

#### Configure Route Details

Description

Outgoing Interface

Preference

Verify Reachability

Operation\*

Dest Prefix\*   
IPv4 destination prefix.

Next Hop    
IPv4 address of the next hop.

6. Configure secondary route towards SCADA back-office network (10.10.1.0/24) with GRE1 as the outgoing interface and preference value of 20.

- From the same page, click 'Add' to add the secondary route over GRE1 tunnel interface:

## Routing ↻

Status Basic Config **Advanced Config** Actions

IPv4

### Route

Search  Add ... Delete Move ▾

| ID | Description | Outgoing Interface | Preference | Verify Reachability - Operation | Dest Prefix  | Next Hop    |
|----|-------------|--------------------|------------|---------------------------------|--------------|-------------|
| 1  |             | NxRadio            |            | NX-LINK-CHECK                   | 10.10.1.0/24 | 192.168.1.4 |
| 2  |             | GRE1               | 20         |                                 | 10.10.1.0/24 |             |

Showing 1 to 2 of 2

#### Configure Route Details

Description

Outgoing Interface

Preference

Verify Reachability

Dest Prefix\*   
IPv4 destination prefix.

Next Hop   
IPv4 address of the next hop.



## Using the CLI

- Configure IPsec transport mode connection (a pre-shared-key based example shown below) from REMOTE to SCADA router R1. It is assumed that REMOTE's cell IP address is 10.150.1.10 and R1's is reachable over cell using 10.150.1.1

```
% set services vpn ike policy IKE-POLICY-PSK-R1 auth-method pre-shared-key
% set services vpn ike policy IKE-POLICY-PSK-R1 pre-shared-key test123
% set services vpn ike policy IKE-POLICY-PSK-R1 ciphersuite CS1 encryption-algo aes128-cbc
% set services vpn ike policy IKE-POLICY-PSK-R1 ciphersuite CS1 mac-algo sha256-hmac
% set services vpn ike policy IKE-POLICY-PSK-R1 ciphersuite CS1 dh-group dh14
% set services vpn ike peer R1 ike-policy IKE-POLICY-PSK-R1
% set services vpn ike peer R1 local-endpoint address 10.150.1.10
% set services vpn ike peer R1 local-identity default
% set services vpn ike peer R1 peer-endpoint address 10.150.1.1
% set services vpn ike peer R1 peer-identity default
% set services vpn ike peer R1 role initiator
% set services vpn ike peer R1 initiator-mode on-demand
% set services vpn ipsec policy IPSEC-POLICY ciphersuite CS1 encryption-algo aes128-cbc
% set services vpn ipsec policy IPSEC-POLICY ciphersuite CS1 mac-algo sha256-hmac
% set services vpn ipsec policy IPSEC-POLICY ciphersuite CS1 dh-group dh14
% set services vpn ipsec connection R1 ike-peer R1
% set services vpn ipsec connection R1 ipsec-policy IPSEC-POLICY
% set services vpn ipsec connection R1 host-to-host
% set services vpn ipsec connection R1 filter input IN_TRUSTED
% set services vpn ipsec connection R1 filter output OUT_TRUSTED
```

- Configure GRE tunnel interface with mode = ip-over-gre, src-address = Local cell address and dst-address = R1's WAN address.

```
% set interfaces interface GRE1 type gre
% set interfaces interface GRE1 gre-config mode ip-over-gre
% set interfaces interface GRE1 gre-config src-address 10.150.1.10
% set interfaces interface GRE1 gre-config dst-address 10.150.1.1
% set interfaces interface GRE filter input IN_TRUSTED
% set interfaces interface GRE filter output OUT_TRUSTED
```

- Configure a NETMON service icmp-echo-monitor operation named NX-LINK-CHECK that does a periodic link check by pinging R1 over NX interface.

```
% set services netmon operation NX-LINK-CHECK enabled true
% set services netmon operation NX-LINK-CHECK icmp-echo-monitor dst-host 192.168.1.4
```

- Configure primary route towards SCADA back-office network (10.10.1.0/24) with NX as the outgoing interface and with address of R1's interface on NX backhaul as the next-hop. Also, configure this route with verify-reachability using NX-LINK-CHECK operation, which checks the reachability of the back-office network via this route.

```
% set routing static-routes ipv4 route 1 dest-prefix 10.10.1.0/24
% set routing static-routes ipv4 route 1 next-hop 192.168.1.4
% set routing static-routes ipv4 route 1 outgoing-interface NxRadio
% set routing static-routes ipv4 route 1 verify-reachability operation NX-LINK-CHECK
```

- Configure secondary route towards SCADA back-office network (10.10.1.0/24) with GRE1 as the outgoing interface and preference value of 20.

```
% set routing static-routes ipv4 route 2 dest-prefix 10.10.1.0/24
% set routing static-routes ipv4 route 2 outgoing-interface GRE1
```





% set routing static-routes ipv4 route 2 preference 20

## Use Case#2 High Reliability MCR AP to REMOTE Layer-3 Network

Following figure shows a setup to achieve a high reliability network communications between an MCR AP and REMOTE using 900 MHz and Cellular communications in a redundant layer-3 network setup using routing functionality.

MCR to MCR NX+CELL redundant network (layer-3) setup using routing – Use case#2

- NX configured as routed interface (i.e. out of the bridge) in 192.168.0.0/16 network.
- Cell configured with APN that provides static IP address.
- GRE configured as routed interface over Cell
- (Optional) IPsec configured over Cell to provide security.
- Static routes configured for REMOTE#1:  
10.10.6.0/24 -> NX (primary)  
10.10.6.0/24 -> GRE-TUN (backup)
- Static routes configured for REMOTE#2:  
10.10.7.0/24 -> NX (primary)  
10.10.7.0/24 -> GRE-TUN (backup)
- Failover to Cell enabled by checking primary route's reachability by pinging remote's NX interface.

- NX configured as routed interface (i.e. out of the bridge) in 192.168.1.0/24 network.
- Cell configured with APN that provides static IP address.
- GRE configured as routed interface over Cell
- (Optional) IPsec configured over Cell to provide security.
- Static routes configured for AP:  
10.10.1.0/24 -> NX (primary)  
10.10.1.0/24 -> GRE-TUN (backup)
- Failover enabled by checking primary route's reachability by pinging AP's NX interface or by monitoring NX link status.

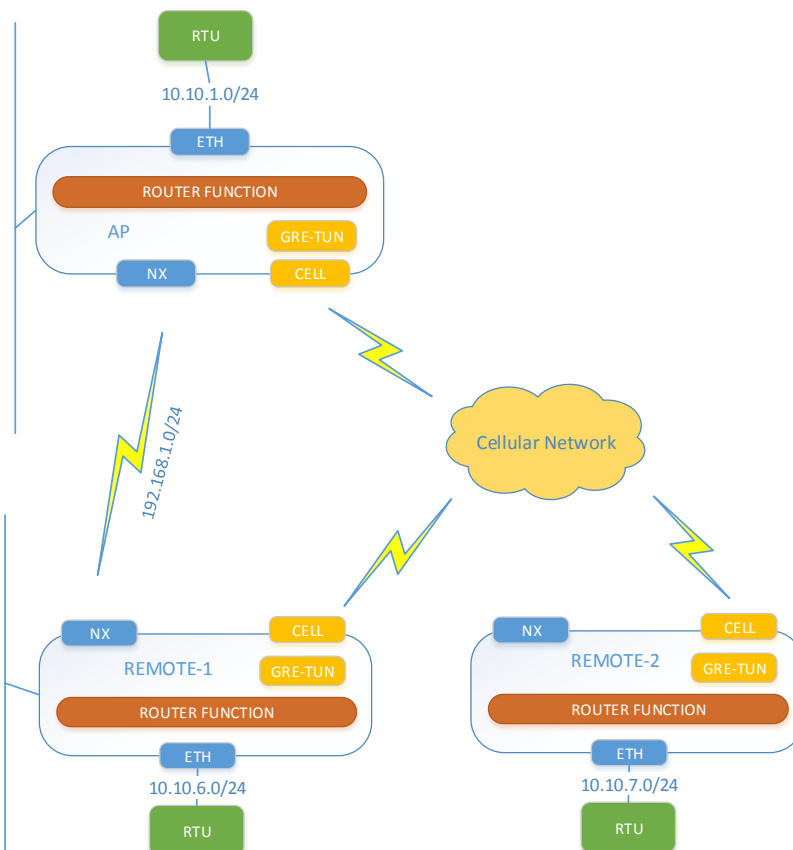


Figure 3-227. MCR to MCR NX+CELL redundant network (layer-3) setup using routing

In above use case, a remote asset (e.g. RTU) connected to AP can send/receive data to/from another remote asset connected to a REMOTE. Both, AP and REMOTE MCR have 900 MHz radio (NX) and Cellular radio options. The NX interface is configured as a routed interface (i.e. outside of the Bridge). All REMOTES have non-overlapping LAN subnet configuration. The IP packets sent by remote asset connected to AP are normally routed by the AP towards the REMOTE over the NX interface. The IP packets sent by remote asset connected to REMOTE are normally routed by the REMOTE towards the AP over the NX interface. Both AP and REMOTE verify the primary link (NX) connectivity by sending periodic ICMP echo requests (pings). In the event that N (configurable) successive pings are lost, both AP and REMOTE update their routing tables to direct traffic over cellular network instead. Both still keep checking the primary link connectivity. Once primary link connectivity is restored (i.e. N successful pings), both AP and REMOTE update their routing tables to direct traffic over NX network.

The above setup is facilitated by same functionality as described in previous section.



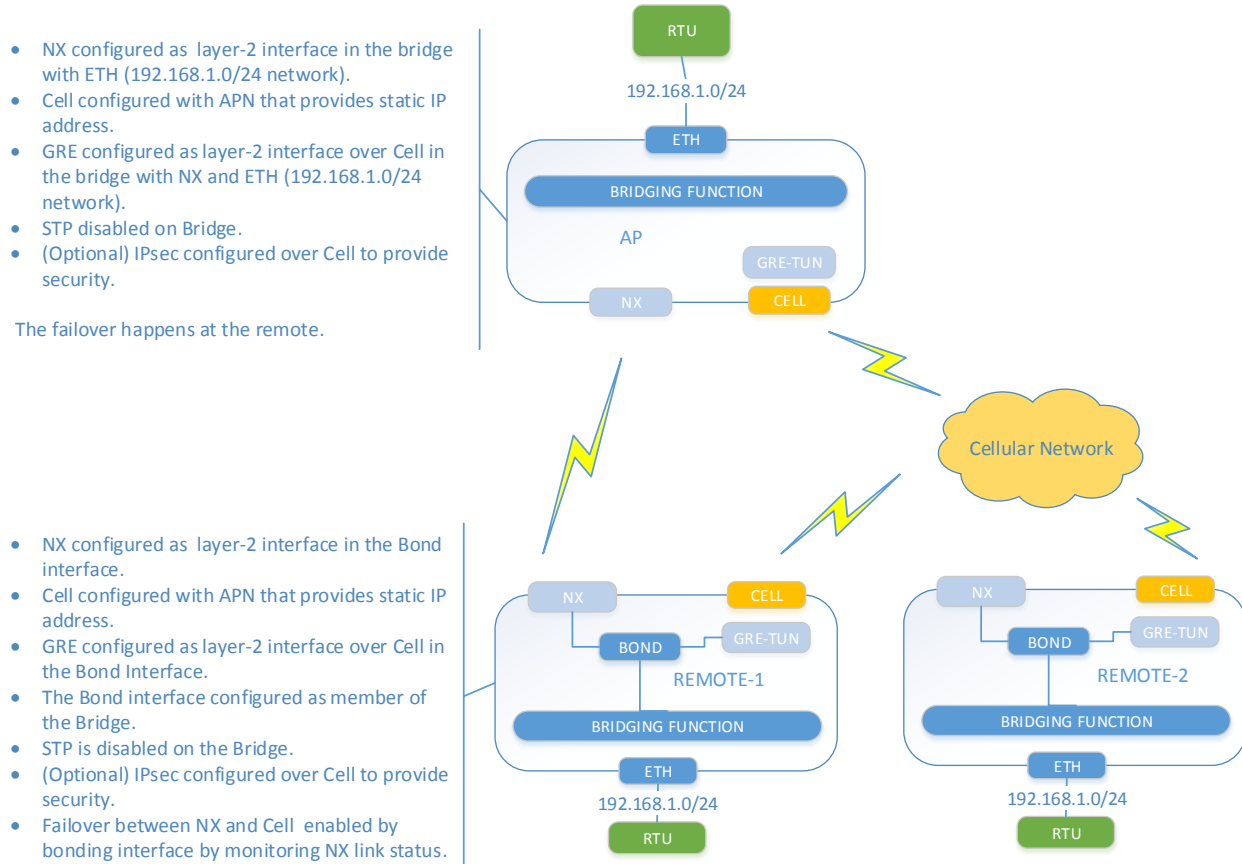
## Configuration

The configuration for the REMOTES and AP for this use case is similar to configuration of REMOTE as described in use case#1, except that at the AP the IPsec is configured in responder mode.

### Use Case#3 High Reliability MCR AP to REMOTE Layer-2 Network

Following figure shows a setup to achieve a high reliability network communications between an MCR AP and REMOTE using 900 MHz and Cellular communications in a redundant layer-2 network setup using bridging and bonding functionality.

MCR to MCR NX+CELL redundant network (layer-2) setup using bridging and bonding – Use Case#3



**Figure 3-228. MCR to MCR NX+CELL redundant network (layer-2) setup using Bridging and Bonding**

In above use case, a remote asset (e.g. RTU) connected to AP can send/receive data to/from another remote asset connected to a REMOTE. Both, AP and REMOTE MCR have 900 MHz radio (NX) and Cellular radio options. This is a typical NX setup where LAN networks connected to both AP and REMOTES are bridged to enable Ethernet communication between any remote assets on the LAN networks. A layer-2 GRE tunnel (ETHERNET-OVER-GRE mode) is setup over Cell. The redundant layer-2 link between AP and REMOTE is achieved by use of a BOND interface on the REMOTE.

A BOND interface bonds two layer-2 interfaces together and presents them as a single layer-2 interface to the rest of the system. Specifically, the BOND interface in active-backup mode enables redundancy between the enslaved interfaces by activating the secondary member link when primary link goes down.

On each REMOTE, the BOND interface bonds NX interface (primary) with GRE layer-2 tunnel interface (secondary) and is itself bridged with the LAN interface. On the AP, the NX and layer-2 GRE tunnel interfaces are bridged with the LAN interface.



On the REMOTE, when the NX link goes down, the BOND interface makes GRE layer-2 tunnel interface as the active interface (after some configurable delay to avoid link flapping) thereby tunneling LAN traffic through the cellular network. When NX link comes back up, the BOND interface makes it the active interface (after some configurable delay to avoid link flapping) thereby restoring layer-2 communications over the NX link.

**NOTE** In this setup, the failover is initiated by the REMOTE. Therefore, a periodic traffic stream is required from REMOTE towards the AP, to update the Bridge forwarding table on the AP, so that traffic for remote assets connected to failed-over REMOTE is sent over the GRE layer-2 tunnel for that REMOTE at the AP. If there is no periodic application data stream from remote assets towards the AP, it is recommended that a NETMON service be setup on the REMOTE that sends ICMP ECHO (ping) requests periodically (say, every 30 secs.) to the AP. The time interval of this periodic data stream will determine the fail-over time for traffic from AP towards the failed-over REMOTE.

## Using the Web UI

### AP Configuration

Following features need to be configured on the AP:

1. IPsec transport mode connection – To secure GRE traffic to/from REMOTE-1 and REMOTE-2 over Cellular network.
2. GRE tunnel – To send/receive layer-2 traffic to/from REMOTE-1 and REMOTE-2's LAN segments over Cellular network.
3. Adding GRE tunnels to the Bridge interface – To enable flow of layer-2 traffic between local LAN segment and REMOTE-1 and REMOTE-2's LAN segments over Cellular network.

### Configure IPsec Transport Mode Connections

1. Configure an IPsec VPN transport mode connection for the REMOTE-1. Please refer to section on IPsec VPN for help with configuring IPsec VPN using Web UI.
2. Configure an IPsec VPN transport mode connection for the REMOTE-2. Please refer to section on IPsec VPN for help with configuring IPsec VPN using Web UI.

### Configure GRE tunnels

1. Configure GRE tunnel interface towards REMOTE-1 with mode = ethernet-over-gre, src-address = 10.150.1.1 (the local Cell interface address as used in IPsec VPN towards REMOTE-1) and dst-address = 10.150.1.10 (the remote Cell interface address as configured in IPsec VPN towards REMOTE-1).
  - Navigate to **Interfaces / Add/Delete Interfaces** and click 'Add' to create new interface named 'GRE-REMOTE-1':

Please select the Interface Type

Type\*

Name:

OK Cancel



## GRE-REMOTE-1 Interface [↻](#)

Status Basic Config **Advanced Config**

▼ General

Description

Enabled

▼ Gre

Gre Config

Mode\* ethernet-over-gre ▼

Src Address\* 10.150.1.1

Dst Address\* 10.150.1.10

Key

Ttl 64

Vpn IPSEC Connection  ...

2. Configure GRE tunnel interface towards REMOTE-2 with mode = ethernet-over-gre, src-address = 10.150.1.1 (the local WAN address as used in IPsec VPN towards REMOTE-2) and dst-address = 10.150.1.20 (the remote WAN address as configured in IPsec VPN towards REMOTE-2).

### Add GRE tunnels to the Bridge interface

1. Add the GRE-REMOTE-1 tunnel interface to the bridge that has NX interface and disable STP on the bridge. Please refer to section on Bridging for help with adding members to a bridge.
2. Add the GRE-REMOTE-2 tunnel interface to the bridge that has NX interface and disable STP on the bridge. Please refer to section on Bridging for help with adding members to a bridge.

### Bridge Interface [↻](#)

Status Basic Config **Advanced Config** Actions

▼ General

Description

Enabled

▼ Bridge

Bridge Settings

**Members**

**Port**

Search  x Add ... Delete 📶 ↻ 🔍 ✎

| Interface    | Port Priority | Port Path Cost |
|--------------|---------------|----------------|
| ETH1         | 32            | 100            |
| GRE-REMOTE-1 | 32            | 100            |
| GRE-REMOTE-2 | 32            | 100            |
| NxRadio      | 32            | 100            |

Showing 1 to 4 of 4



## REMOTE#1 Configuration

Following features need to be configured on this device:

1. IPsec transport mode connection – To secure GRE traffic to/from AP over Cellular network.
2. GRE tunnel – To send/receive layer-2 traffic to/from AP's LAN segments over Cellular network.
3. Bond Interface – To enable failover of layer-2 traffic between NX (primary interface) and GRE tunnel (secondary/backup interface).
4. Adding Bond interface to the Bridge interface – To enable flow of layer-2 traffic between local LAN segment and AP's LAN segments.
5. Network Monitor Operation – To send a periodic traffic to enable failover at the AP as described in the NOTE earlier in this section.

### Configure IPsec Transport Mode Connection

1. Configure an IPsec VPN transport mode connection (host-to-host connection type) for the AP. Please refer to section on IPsec VPN for help with configuring IPsec VPN using Web UI.

### Configure GRE tunnel

1. Configure GRE tunnel interface towards AP with mode = ethernet-over-gre, src-address = 10.150.1.10 (the local Cell interface address as used in IPsec VPN towards AP) and dst-address = 10.150.1.1 (the remote Cell interface address as configured in IPsec VPN towards AP).
  - Navigate to **Interfaces / Add/Delete Interfaces** and click 'Add' to create new interface named 'GRE1':

Please select the Interface Type

Type\*

Name:

OK Cancel



## GRE-AP Interface ↻

Status Basic Config **Advanced Config**

▼ General

Description

Enabled

▼ Gre

Gre Config

Mode\* ethernet-over-gre ▼

Src Address\* 10.150.1.10

Dst Address\* 10.150.1.1

Key

Ttl 64

Vpn IPSEC Connection  ...

### Configure BOND interface

1. Configure BOND interface in 'active-backup' mode with NxRadio and GRE-AP as members and NxRadio as the primary member.
  - Navigate to **Interfaces / Add/Delete Interfaces** and click 'Add' to create new interface named 'Bond1':

Please select the Interface Type

Type\* Bond ▼

Name: Bond1|

OK Cancel



## Bond1 Interface

Status Basic Config Advanced Config Actions

General

Description

Enabled

Bond

**Bond Config**

Mode\* active-backup

**Member**

Search  Add ... Delete

| Interface |
|-----------|
| GRE-AP    |
| NxRadio   |

### Add BOND interface to the Bridge

1. Add the **Bond1** tunnel interface to the bridge that has NX interface and disable STP on the bridge. Please refer to section on Bridging for help with adding members to a bridge.

## Bridge Interface

Status Basic Config Advanced Config Actions

General

Bridge

**Bridge Settings**

**Members**

**Port**

Search  Add ... Delete

| Interface | Port Priority | Port Path Cost |
|-----------|---------------|----------------|
| Bond1     | 32            | 100            |
| ETH1      | 32            | 100            |
| ETH2      | 32            | 100            |

Showing 1 to 3 of 3

Stp Mode

Ageing Time

Max Age

Hello Time

Forward Delay

Bridge Priority

### Configure NETMON operation

1. Configure a **NETMON** service icmp-echo-monitor operation named NX-LINK-CHECK that does a periodic link check by pinging AP. This is needed to generate a periodic traffic towards AP to enable the latter to update its bridge forwarding table when the REMOTE switches its link from NX to/from GRE tunnel. The time interval of this traffic determines the time interval of failover at the AP. Please refer NETMON service section for help with configuration.



## Netmon Service [↗](#)

|        |              |                 |         |
|--------|--------------|-----------------|---------|
| Status | Basic Config | Advanced Config | Actions |
|--------|--------------|-----------------|---------|

| General       |         |                   |                               |                                |                              |                              |
|---------------|---------|-------------------|-------------------------------|--------------------------------|------------------------------|------------------------------|
| Operation     |         |                   |                               |                                |                              |                              |
| Search        | x       | Add ...           |                               | Delete                         |                              | ⌵ ⌴ 🔍 ✎                      |
| Name          | Enabled | Type              | Interface Monitor - Interface | Interface Monitor - Down Delay | Interface Monitor - Up Delay | Icmp Echo Monitor - Dst Host |
| NX-LINK-CHECK | true    | icmp-echo-monitor |                               |                                |                              | 192.168.1.4                  |

Showing 1 to 1 of 1

## REMOTE#2 Configuration

Following features need to be configured on this device:

1. IPsec transport mode connection – To secure GRE traffic to/from AP over Cellular network.
2. GRE tunnel – To send/receive layer-2 traffic to/from AP’s LAN segments over Cellular network.
3. Bond Interface – To enable failover of layer-2 traffic between NX (primary interface) and GRE tunnel (secondary/backup interface).
4. Adding Bond interface to the Bridge interface – To enable flow of layer-2 traffic between local LAN segment and AP’s LAN segments.
5. Network Monitor Operation – To send a periodic traffic to enable failover at the AP as described in the NOTE earlier in this section.

### Configure IPsec transport mode connection

1. Configure an IPsec VPN transport mode connection (host-to-host connection type) for the AP. Please refer to section on IPsec VPN for help with configuring IPsec VPN using Web UI.

### Configure GRE tunnel

1. Configure GRE tunnel interface towards AP with mode = ethernet-over-gre, src-address = 10.150.1.20 (the local Cell interface address as used in IPsec VPN towards AP) and dst-address = 10.150.1.1 (the remote Cell interface address as configured in IPsec VPN towards AP).
  - Navigate to **Interfaces / Add/Delete Interfaces** and click ‘Add’ to create new interface named ‘GRE-AP’:

Please select the Interface Type

Type\*

Name:

OK Cancel





## GRE-AP Interface

Status Basic Config **Advanced Config**

▼ General

Description

Enabled

▼ Gre

Gre Config

Mode\* ethernet-over-gre ▼

Src Address\* 10.150.1.20

Dst Address\* 10.150.1.1

Key

Ttl 64

Vpn IPSEC Connection  ...

### Configure BOND interface

1. Configure BOND interface in 'active-backup' mode with NxRadio and GRE-AP as members and NxRadio as the primary member.
  - Navigate to **Interfaces / Add/Delete Interfaces** and click 'Add' to create new interface named 'Bond1':

Please select the Interface Type

Type\* Bond ▼

Name: Bond1|

OK Cancel



## Bond1 Interface

Status Basic Config **Advanced Config** Actions

General

Description

Enabled

Bond

**Bond Config**

Mode\* active-backup

**Member**

Search  Add ... Delete

| Interface |
|-----------|
| GRE-AP    |
| NxRadio   |

### Add BOND interface to the Bridge

1. Add the **Bond1** tunnel interface to the bridge that has NX interface and disable STP on the bridge. Please refer to section on Bridging for help with adding members to a bridge.

## Bridge Interface

Status Basic Config **Advanced Config** Actions

General

Bridge

**Bridge Settings**

**Members**

**Port**

Search  Add ... Delete

| Interface | Port Priority | Port Path Cost |
|-----------|---------------|----------------|
| Bond1     | 32            | 100            |
| ETH1      | 32            | 100            |
| ETH2      | 32            | 100            |

Showing 1 to 3 of 3

Stp Mode

Ageing Time

Max Age

Hello Time

Forward Delay

Bridge Priority

### Configure NETMON operation

1. Configure a **NETMON** service icmp-echo-monitor operation named NX-LINK-CHECK that does a periodic link check by pinging AP. This is needed to generate a periodic traffic towards AP to enable the latter to update its bridge forwarding table when the REMOTE switches its link from NX to/from GRE tunnel. The time interval of this traffic determines the time interval of failover at the AP. Please refer NETMON service section for help with configuration.



## Netmon Service [↗](#)

| General       |         |                   |                               |                                |                              |                              |
|---------------|---------|-------------------|-------------------------------|--------------------------------|------------------------------|------------------------------|
| Operation     |         |                   |                               |                                |                              |                              |
| Name          | Enabled | Type              | Interface Monitor - Interface | Interface Monitor - Down Delay | Interface Monitor - Up Delay | Icmp Echo Monitor - Dst Host |
| NX-LINK-CHECK | true    | icmp-echo-monitor |                               |                                |                              | 192.168.1.4                  |

Showing 1 to 1 of 1

Above NETMON configuration assumes AP's bridge interface IP address is 192.168.1.4.

---

**NOTE** Since the AP and REMOTEs are now part of a single layer-2 network, the bridge interfaces need to be assigned distinct IP addresses.

---

## Using the CLI

Configurable IPsec tunnel (a pre-shared-key based example shown below) from REMOTE to AP. It is assumed that REMOTE-1's cell IP address is 10.150.1.10, REMOTE-2's cell IP address is 10.150.1.20 and AP's cell IP address is 10.150.1.1.

## AP Configuration

- Configure IPsec transport mode connections

```
% set services vpn enabled true
% set services vpn ike policy REMOTE-1_ike_policy auth-method pre-shared-key
% set services vpn ike policy REMOTE-1_ike_policy pre-shared-key remote1
% set services vpn ike policy REMOTE-1_ike_policy ciphersuite ike_policy_cipher0
% set services vpn ike policy REMOTE-1_ike_policy life-time 180
% set services vpn ike peer REMOTE-1_ike_peer ike-policy REMOTE-1_ike_policy
% set services vpn ike peer REMOTE-1_ike_peer local-endpoint address 10.150.1.1
% set services vpn ike peer REMOTE-1_ike_peer local-identity default
% set services vpn ike peer REMOTE-1_ike_peer peer-endpoint address 10.150.1.10
% set services vpn ike peer REMOTE-1_ike_peer peer-identity default
% set services vpn ike peer REMOTE-2_ike_peer role responder
% set services vpn ipsec policy REMOTE-1_ipsec_policy ciphersuite ipsec_policy_cipher0
% set services vpn ipsec policy REMOTE-1_ipsec_policy life-time 60
% set services vpn ipsec connection REMOTE-1 ike-peer REMOTE-1_ike_peer
% set services vpn ipsec connection REMOTE-1 ipsec-policy REMOTE-1_ipsec_policy
% set services vpn ipsec connection REMOTE-1 host-to-host
% set services vpn ipsec connection REMOTE-1 filter input IN_TRUSTED
% set services vpn ipsec connection REMOTE-1 filter output OUT_TRUSTED

% set services vpn ike policy REMOTE-2_ike_policy auth-method pre-shared-key
% set services vpn ike policy REMOTE-2_ike_policy pre-shared-key remote2
% set services vpn ike policy REMOTE-2_ike_policy ciphersuite ike_policy_cipher0
% set services vpn ike policy REMOTE-2_ike_policy life-time 180
% set services vpn ike peer REMOTE-2_ike_peer ike-policy REMOTE-2_ike_policy
% set services vpn ike peer REMOTE-2_ike_peer local-endpoint address 10.150.1.1
% set services vpn ike peer REMOTE-2_ike_peer local-identity default
% set services vpn ike peer REMOTE-2_ike_peer peer-endpoint address 10.150.1.20
```



```
% set services vpn ike peer REMOTE-2_ike_peer peer-identity default
% set services vpn ike peer REMOTE-2_ike_peer role responder
% set services vpn ipsec policy REMOTE-2_ipsec_policy ciphersuite ipsec_policy_cipher0
% set services vpn ipsec policy REMOTE-2_ipsec_policy life-time 60
% set services vpn ipsec connection REMOTE-2 ike-peer REMOTE-2_ike_peer
% set services vpn ipsec connection REMOTE-2 ipsec-policy REMOTE-2_ipsec_policy
% set services vpn ipsec connection REMOTE-2 host-to-host
% set services vpn ipsec connection REMOTE-2 filter input IN_TRUSTED
% set services vpn ipsec connection REMOTE-2 filter output OUT_TRUSTED
```

- Configure GRE tunnel interfaces in ethernet-over-gre mode

```
% set interfaces interface GRE-REMOTE-1 type gre
% set interfaces interface GRE-REMOTE-1 gre-config mode ethernet-over-gre
% set interfaces interface GRE-REMOTE-1 gre-config src-address 10.150.1.1
% set interfaces interface GRE-REMOTE-1 gre-config dst-address 10.150.1.10
```

```
% set interfaces interface GRE-REMOTE-2 type gre
% set interfaces interface GRE-REMOTE-2 gre-config mode ethernet-over-gre
% set interfaces interface GRE-REMOTE-2 gre-config src-address 10.150.1.1
% set interfaces interface GRE-REMOTE-2 gre-config dst-address 10.150.1.20
```

- Add the GRE tunnel interfaces to the bridge and disable STP on the bridge

```
% set interfaces interface Bridge bridge-settings members port GRE-REMOTE-1
% set interfaces interface Bridge bridge-settings members port GRE-REMOTE-2
% set interfaces interface Bridge bridge-settings stp-mode disabled
```

## REMOTE#1 Configuration

- Configure IPsec tunnel

```
% set services vpn enabled true
% set services vpn ike policy AP_ike_policy auth-method pre-shared-key
% set services vpn ike policy AP_ike_policy pre-shared-key remote1
% set services vpn ike policy AP_ike_policy ciphersuite ike_policy_cipher0
% set services vpn ike policy AP_ike_policy life-time 180
% set services vpn ike policy AP_ike_policy reauth true
% set services vpn ike peer AP_ike_peer ike-policy AP_ike_policy
% set services vpn ike peer AP_ike_peer local-endpoint address 10.150.1.10
% set services vpn ike peer AP_ike_peer local-identity default
% set services vpn ike peer AP_ike_peer peer-endpoint address 10.150.1.1
% set services vpn ike peer AP_ike_peer peer-identity default
% set services vpn ike peer AP_ike_peer role initiator
% set services vpn ike peer AP_ike_peer initiator-mode on-demand
% set services vpn ipsec policy AP_ipsec_policy ciphersuite ipsec_policy_cipher0
% set services vpn ipsec policy AP_ipsec_policy life-time 60
% set services vpn ipsec connection AP ike-peer AP_ike_peer
% set services vpn ipsec connection AP ipsec-policy AP_ipsec_policy
% set services vpn ipsec connection AP host-to-host
% set services vpn ipsec connection AP filter input IN_TRUSTED
% set services vpn ipsec connection AP filter output OUT_TRUSTED
```

- Configure GRE tunnel interface

```
% set interfaces interface GRE-AP type gre
% set interfaces interface GRE-AP gre-config mode ethernet-over-gre
```



```
% set interfaces interface GRE-AP gre-config src-address 10.150.1.10
% set interfaces interface GRE-AP gre-config dst-address 10.150.1.1
```

- Configure BOND interface in ‘active-backup’ mode with NxRadio and GRE-AP as members and NxRadio as the primary member.

```
% set interfaces interface Bond1 type bond
% set interfaces interface Bond1 bond-config mode active-backup
% set interfaces interface Bond1 bond-config member NxRadio
% set interfaces interface Bond1 bond-config member GRE-AP
% set interfaces interface Bond1 bond-config primary-member NxRadio
```

- Add BOND1 interface to Bridge disable STP on the bridge.

```
% set interfaces interface Bridge bridge-settings members port Bond1
% set interfaces interface Bridge bridge-settings stp-mode disabled
```

- Configure a NETMON service icmp-echo-monitor operation named NX-LINK-CHECK that does a periodic link check by pinging AP. This is needed to generate a periodic traffic towards AP (say every 5 secs) to enable the latter to update its bridge forwarding table when the REMOTE switches its link from NX to/from GRE tunnel.

```
% set services netmon operation NX-LINK-CHECK enabled true
% set services netmon operation NX-LINK-CHECK icmp-echo-monitor dst-host 192.168.1.4
% set services netmon operation NX-LINK-CHECK icmp-echo-monitor interval 5
```

## REMOTE#2 Configuration

Configuration is similar to REMOTE#1.



## 3.8.21 Dynamic Routing

### Understanding

Dynamic routing consists of routers building and maintaining routing tables automatically through an ongoing communication between them. This communication is facilitated by a routing protocol, which consists of a series of periodic or on-demand messages containing routing information that is exchanged between the routers.

The unit supports following routing protocols to enable dynamic routing:

- Routing Information protocol (RIP)- The unit support RIPv2 (RFC 1723, RFC4822)
- Open Shortest Path First (OSPF) – The unit supports OSPFv2 (RFC 2328)
- Border Gateway Protocol (BGP) – The unit support BGPv4 (RFC 4271).

Following reference can be consulted for a technical overview of RIP:

[http://docwiki.cisco.com/wiki/Routing\\_Information\\_Protocol](http://docwiki.cisco.com/wiki/Routing_Information_Protocol)

Following reference can be consulted for a technical overview of OSPF:

[http://docwiki.cisco.com/wiki/Open\\_Shortest\\_Path\\_First](http://docwiki.cisco.com/wiki/Open_Shortest_Path_First)

Following reference can be consulted for a technical overview of BGP:

[http://docwiki.cisco.com/wiki/Border\\_Gateway\\_Protocol](http://docwiki.cisco.com/wiki/Border_Gateway_Protocol)

The user can control the routes that are imported into the routing table from the routing protocol and those that are exported into the routing protocol from the routing table by using *route filters*.

The *import* route filter controls the routes that are imported into the routing table by the routing protocol. By default, the routing protocol allows all routes received from the peer router to be imported into the routing table. That is, if no import filter is configured, default action is ACCEPT.

The *export* route filter controls the routes that are exported into the routing protocol from the routing table. By default, the routing protocol prevents export of any routes from the local routing table to the peer router. That is, if no export filter is configured, default action is NONE.

A route filter consists of one or more rules sorted by a numeric identifier. Each rule in route filter consists of ‘match’ and ‘actions’ configuration. The parameters in the match are compared against the route being imported (if this route filter is used as import filter) or exported (if this route filter is used as export filter) into/from the routing table. If the route matches, the action (ACCEPT OR REJECT) specified in the actions configuration is applied.

When routing protocol receives a route from the peer router it checks whether the route is allowed by the import filter by comparing it against one or more rules configured in the filter (in order of their configuration). If any rule matches, the corresponding action (ACCEPT or REJECT) is applied. Similarly, for each route in the routing table, the routing protocol checks whether it is allowed by the export filter before exporting it to the peer routers. In addition, some general attributes of the route like NEXT-HOP or routing protocol specific attributes like BGP AS-PATH, LOCAL-PREF etc can be modified when exporting routes using ‘set’.

### Use Cases

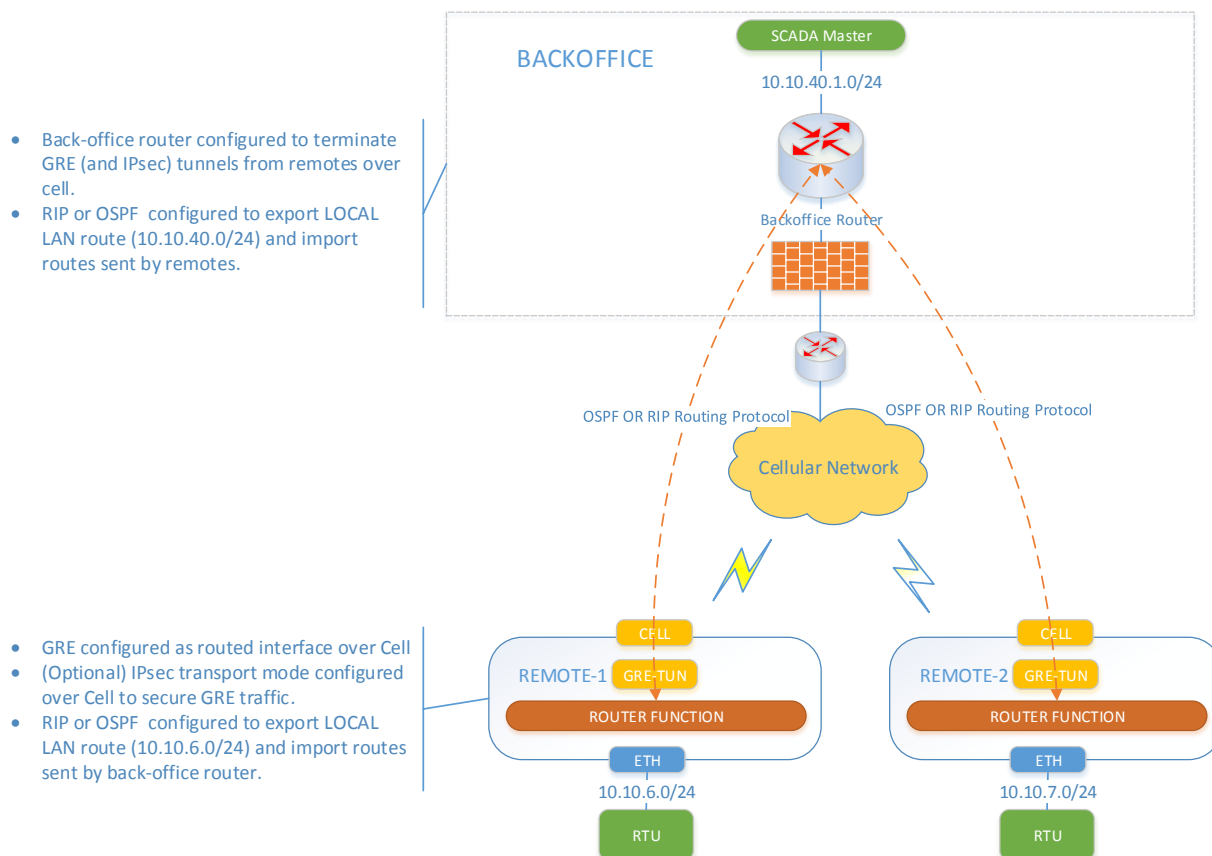
The figure below describes one of the use cases for dynamic routing on the unit. In this case, dynamic a routing protocol is used to exchange locally connected LAN route with a router in the back-office (and vice versa) over the Cellular WAN interface. Both OSPF and RIP exchange routing updates with peers



using multicast. BGP uses TCP connection with peer to exchange routes. The cellular interface by itself is not capable multicasting. Therefore, in this use case, a GRE tunnel interface needs to be used over Cell. Further, IPsec in transport mode can be used to secure GRE traffic over Cell. Please refer to sections on GRE and IPsec on how to setup GRE over IPsec. The configuration examples below assume that an interface named 'GRE' has been configured to tunnel routing updates to the back-office router.

**NOTE** The GRE interface needs to be configured with an IP address for the dynamic routing protocols to operate over it.

Dynamic Routing between SCADA Back-office and Remote LAN



## Configuring

Following example shows how to create a route filter to export route for a directly connected local LAN (i.e. direct/interface route for Bridge interface for a unit with factory default configuration).

Navigate to **Routing->Basic Config->Route filters**

Click 'Add' to create a route filter named **LOCAL\_LAN**.



## Routing [↗](#)

Status Basic Config **Advanced Config** Actions

General

Router ID

Static Routes

Route Filters

### Route Filter

Search  Add ... Delete

Name

Table is empty

### Route Filter Details

Name\* LOCAL\_LAN

Add Cancel

Select the newly created **LOCAL\_LAN** route filter and click **'Add'** to add a rule with **ID=1** to this filter.

### Route Filter

Search  Add ... Delete

Name LOCAL\_LAN

Showing 1 to 1 of 1

### Configure Route Filter Details

#### Rule

Search  Add ... Delete

| ID             | Match - Dest Prefix | Match - Source Protocol | Match - Source Router | Match - Outgoing Interface | Match - Next Hop | Actions - Action |
|----------------|---------------------|-------------------------|-----------------------|----------------------------|------------------|------------------|
| Table is empty |                     |                         |                       |                            |                  |                  |

#### Rule Details

ID\* 1

Add Cancel

Select **'outgoing-interface= Bridge'** and **Action='accept'**.

### Rule

Search  Add ... Delete

| ID | Match - Dest Prefix | Match - Source Protocol | Match - Source Router | Match - Outgoing Interface | Match - Next Hop | Actions - Action |
|----|---------------------|-------------------------|-----------------------|----------------------------|------------------|------------------|
| 1  |                     |                         |                       |                            |                  |                  |

Showing 1 to 1 of 1

### Rule Details

#### Match

Dest Prefix

Source Protocol

Source Router

Outgoing Interface

Next Hop

#### Actions

Action\*

Click **Finish** on the panels to close them.

To apply configuration, click **Save**.





**NOTE** At this point route filter has been created. However, one needs to use the route filter as an export/import filter in the routing protocol configuration for it to take effect.

## Using CLI

In **configuration** mode, enter following commands:

```
% set routing route-filter LOCAL_LAN rule 1 match outgoing-interface Bridge
% set routing route-filter LOCAL_LAN rule 1 actions action accept
% commit
```

Following sections describe configuration for specific routing protocols.

## RIP

The basic RIP configuration consists of enabling the protocol and adding interfaces on which it should operate and configuring an export filter. In addition, MD5 authentication can be used to secure routing protocol updates. In the example, below RIP is enabled on GRE interface along with LOCAL\_LAN as the export filter.

Navigate to **Routing->Basic Config->RIP**

Select '**LOCAL\_LAN**' as the export filter.

Under '**Interface**', click '**Add**' to add an interface on which RIP should operate.

▼ RIP

Enabled

Preference

Import Filter

Export Filter LOCAL\_LAN

### Authentication

Type none

### Interface

Search  Add ... Delete

| Name           | Cost | Mode |
|----------------|------|------|
| Table is empty |      |      |

### Interface Details

Name\* GRE

To apply configuration, click **Save**.

## Using CLI

In configuration mode, enter following commands:

```
% set routing rip enabled true
% set routing rip export-filter LOCAL_LAN
% set routing rip interface GRE
```



% commit

## Monitoring

Navigate to *Routing-> Status*

The user can check the routing table in the ‘**General**’ panel to ensure a **dynamic** route for the back-office has been received from the back-office router.

## Routing

Status Basic Config Advanced Config Actions

General

### Routes

Search

| Dest Prefix       | Next Hop       | Outgoing Interface | Source  |
|-------------------|----------------|--------------------|---------|
| 0.0.0.0/0         | 172.18.175.129 | Cell               | kernel  |
| 10.10.6.0/24      |                | Bridge             | kernel  |
| 10.10.40.0/24     |                | GRE                | dynamic |
| 172.18.175.128/28 |                | Cell               | kernel  |

The ‘RIP’ panel, displays the state of RIP routing protocol including route import/export statistics.

RIP

Routing Instance: MAIN\_RIP Refresh every  seconds  
 State: up  
 Preference: 120  
 Import Filter: ACCEPT  
 Export Filter: LOCAL\_LAN

### Statistics

|                           |   |
|---------------------------|---|
| Import Updates Received   | 1 |
| Import Updates Rejected   | 0 |
| Import Updates Filtered   | 0 |
| Import Updates Ignored    | 0 |
| Import Updates Accepted   | 1 |
| Import Withdraws Received | 0 |
| Import Withdraws Rejected | 0 |
| Import Withdraws Ignored  | 0 |
| Import Withdraws          | 0 |

## Using CLI

In **operational** mode, enter following commands:



> **show routing-state routes**

| DEST PREFIX       | NEXT HOP       | OUTGOING<br>INTERFACE | SOURCE  |
|-------------------|----------------|-----------------------|---------|
| 0.0.0.0/0         | 172.18.175.129 | Cell                  | kernel  |
| 10.10.6.0/24      | -              | Bridge                | kernel  |
| 10.10.40.0/24     | -              | GRE                   | dynamic |
| 172.18.175.128/28 | -              | Cell                  | kernel  |

> **show routing-state rip**

```
routing-state rip routing-instance MAIN_RIP
routing-state rip state up
routing-state rip preference 120
routing-state rip import-filter ACCEPT
routing-state rip export-filter LOCAL_LAN
routing-state rip statistics import-updates-received 1
routing-state rip statistics import-updates-rejected 0
routing-state rip statistics import-updates-filtered 0
routing-state rip statistics import-updates-ignored 0
routing-state rip statistics import-updates-accepted 1
routing-state rip statistics import-withdraws-received 0
routing-state rip statistics import-withdraws-rejected 0
routing-state rip statistics import-withdraws-ignored 0
routing-state rip statistics import-withdraws-accepted 0
routing-state rip statistics export-updates-received 10
routing-state rip statistics export-updates-rejected 1
routing-state rip statistics export-updates-filtered 7
routing-state rip statistics export-updates-accepted 2
routing-state rip statistics export-withdraws-received 0
routing-state rip statistics export-withdraws-accepted 0
```

## OSPF

The basic OSPF configuration consists of enabling the protocol, creating backbone area 0.0.0.0 and adding interfaces to this area on which the protocol should operate and configuring an export filter. In addition, MD5 authentication can be used to secure routing protocol updates on per-interface basis. In the example below, OSPF is enabled with area 0.0.0.0 containing GRE interface along with LOCAL\_LAN as the export filter.

Navigate to **Routing->Basic Config->OSPF**

Select 'LOCAL\_LAN' as the export filter.



Under 'Area,' click 'Add' to add area 0.0.0.0 (backbone)

The screenshot shows the OSPF configuration page. Under the 'Area' section, there is a search bar and 'Add ...' and 'Delete' buttons. Below this is a table with columns: ID, Stub, Nssa, Summary, Default Route Nssa, Default Route Cost, and Default Route Cost 2. The table is empty. Below the table is the 'Area Details' section with a form for 'ID\*' containing '0.0.0.0' and 'Add' and 'Cancel' buttons.

Under 'Interface,' click 'Add' to add GRE interface to area 0.0.0.0.

The screenshot shows the 'Interface' configuration page. Under the 'Interface' section, there is a search bar and 'Add ...' and 'Delete' buttons. Below this is a table with columns: Name, Network Type, Priority, Poll Interval, Cost, Hello Interval, and Retransmit Interval. The table is empty. Below the table is the 'Interface Details' section with a form for 'Name\*' containing 'GRE' and 'Add' and 'Cancel' buttons.

To apply configuration, click **Save**.

## Using CLI

In **configuration** mode, enter following commands:



```

% set routing ospf enabled true
% set routing ospf export-filter LOCAL_LAN
% set routing ospf area 0.0.0.0 interface GRE
% commit

```

## Monitoring

Navigate to **Routing-> Status**

The user can check the routing table in the ‘General’ panel to ensure a dynamic route for the back-office has been received from the back-office router.

## Routing

Status Basic Config Advanced Config Actions

---

General

### Routes

Search

| Dest Prefix       | Next Hop       | Outgoing Interface | Source  |
|-------------------|----------------|--------------------|---------|
| 0.0.0.0/0         | 172.18.175.129 | Cell               | kernel  |
| 10.10.6.0/24      |                | Bridge             | kernel  |
| 10.10.40.0/24     |                | GRE                | dynamic |
| 172.18.175.128/28 |                | Cell               | kernel  |

The ‘OSPF’ panel, displays the state of OSPF routing protocol including route import/export statistics and other OSPF protocol status.

OSPF

Routing Instance MAIN\_OSPF Refresh every  seconds

State up

Preference 150

Import Filter ACCEPT

Export Filter LOCAL\_LAN

### Statistics

|                           |   |
|---------------------------|---|
| Import Updates Received   | 4 |
| Import Updates Rejected   | 0 |
| Import Updates Filtered   | 0 |
| Import Updates Ignored    | 0 |
| Import Updates Accepted   | 4 |
| Import Withdraws Received | 1 |
| Import Withdraws Rejected | 0 |
| Import Withdraws Ignored  | 0 |
| Import Withdraws          | 1 |



The 'Area' table displays status of OSPF areas. The 'Interface' table displays interface state. The 'Neighbor' table displays the routers with which the unit has exchanged OSPF 'Hello' messages and those with which it has established adjacencies (i.e. exchanged routing database).

### Area

Search  x 📶 🔄 👁 🔍 🛠

| ID      | Stub  | Nssa  | Transit | Nssa Translation | Num Interfaces | Num Neighbors |
|---------|-------|-------|---------|------------------|----------------|---------------|
| 0.0.0.0 | false | false | false   | false            | 1              | 1             |

Showing 1 to 1 of 1

### Interface

Search  x 📶 🔄 👁 🔍 🛠

| Name | Virtual Link | Peer Address | Transit Area ID | Network Type | Area ID | State |
|------|--------------|--------------|-----------------|--------------|---------|-------|
| GRE  | false        |              |                 | bcast        | 0.0.0.0 | bdr   |

Showing 1 to 1 of 1

### Neighbor

Search  x 📶 🔄 👁 🔍 🛠

| ID      | Address     | Interface | State   | Priority | Dead Time |
|---------|-------------|-----------|---------|----------|-----------|
| 2.2.2.2 | 192.168.1.4 | GRE       | Full/DR | 128      | 37        |

Showing 1 to 1 of 1

The 'Lsa' table displays all link state advertisements (LSAs) received by this router.

### Lsa

Search  x 📶 🔄 👁 🔍 🛠

| Scope        | Type | Ls ID       | Adv Router | Age | Sequence | Checksum |
|--------------|------|-------------|------------|-----|----------|----------|
| Global       | 0005 | 10.10.40.0  | 2.2.2.2    | 67  | 80000001 | 105e     |
| Global       | 0005 | 10.10.6.255 | 10.10.6.1  | 69  | 80000001 | cb9a     |
| Area 0.0.0.0 | 0002 | 192.168.1.4 | 2.2.2.2    | 21  | 80000002 | 049b     |
| Area 0.0.0.0 | 0001 | 2.2.2.2     | 2.2.2.2    | 21  | 80000004 | 8785     |
| Area 0.0.0.0 | 0001 | 10.10.6.1   | 10.10.6.1  | 22  | 80000002 | d25b     |

Showing 1 to 5 of 5

## Using CLI

In **operational** mode, enter following commands:

> **show routing-state routes**

| DEST PREFIX       | NEXT HOP       | OUTGOING INTERFACE | SOURCE  |
|-------------------|----------------|--------------------|---------|
| 0.0.0.0/0         | 172.18.175.129 | Cell               | kernel  |
| 10.10.6.0/24      | -              | Bridge             | kernel  |
| 10.10.40.0/24     | -              | GRE                | dynamic |
| 172.18.175.128/28 | -              | Cell               | kernel  |

> **show routing-state ospf**

```

routing-state ospf routing-instance MAIN_OSPF
routing-state ospf state up
routing-state ospf preference 150
routing-state ospf import-filter ACCEPT
routing-state ospf export-filter LOCAL_LAN

```



```
routing-state ospf statistics import-updates-received 4
routing-state ospf statistics import-updates-rejected 0
routing-state ospf statistics import-updates-filtered 0
routing-state ospf statistics import-updates-ignored 0
routing-state ospf statistics import-updates-accepted 4
routing-state ospf statistics import-withdraws-received 1
routing-state ospf statistics import-withdraws-rejected 0
routing-state ospf statistics import-withdraws-ignored 0
routing-state ospf statistics import-withdraws-accepted 1
routing-state ospf statistics export-updates-received 7
routing-state ospf statistics export-updates-rejected 2
routing-state ospf statistics export-updates-filtered 4
routing-state ospf statistics export-updates-accepted 1
routing-state ospf statistics export-withdraws-received 1
routing-state ospf statistics export-withdraws-accepted 0
routing-state ospf area 0.0.0.0
  stub          false
  nssa          false
  transit       false
  nssa-translation  false
  num-interfaces  1
  num-neighbors  1
  num-adjacent-neighbors 1
  area-networks  [ ]
routing-state ospf interface GRE
routing-state ospf routing-instance MAIN_OSPF
routing-state ospf state up
routing-state ospf preference 150
routing-state ospf import-filter ACCEPT
routing-state ospf export-filter LOCAL_LAN
routing-state ospf statistics import-updates-received 4
routing-state ospf statistics import-updates-rejected 0
routing-state ospf statistics import-updates-filtered 0
routing-state ospf statistics import-updates-ignored 0
routing-state ospf statistics import-updates-accepted 4
routing-state ospf statistics import-withdraws-received 1
routing-state ospf statistics import-withdraws-rejected 0
routing-state ospf statistics import-withdraws-ignored 0
routing-state ospf statistics import-withdraws-accepted 1
routing-state ospf statistics export-updates-received 7
routing-state ospf statistics export-updates-rejected 2
routing-state ospf statistics export-updates-filtered 4
routing-state ospf statistics export-updates-accepted 1
routing-state ospf statistics export-withdraws-received 1
routing-state ospf statistics export-withdraws-accepted 0
routing-state ospf area 0.0.0.0
  stub          false
  nssa          false
  transit       false
  nssa-translation  false
  num-interfaces  1
```



```

num-neighbors          1
num-adjacent-neighbors 1
area-networks          [ ]
routing-state ospf interface GRE
virtual-link           false
network-type           bcast
area-id                0.0.0.0
state                  bdr
priority               1
cost                   10
hello-interval         10
wait-interval          40
dead-interval          40
retransmit-interval    5
designated-router-id    2.2.2.2
designated-router-address 192.168.1.4
backup-designated-router-id 10.10.6.1
backup-designated-router-address 192.168.6.5

```

| ID      | ADDRESS     | INTERFACE | STATE   | PRIORITY | DEAD TIME |
|---------|-------------|-----------|---------|----------|-----------|
| 2.2.2.2 | 192.168.1.4 | GRE       | Full/DR | 128      | 37        |

| SCOPE        | ADV TYPE | LS ID       | ROUTER    | AGE  | SEQUENCE | CHECKSUM      |
|--------------|----------|-------------|-----------|------|----------|---------------|
| Global       | 0005     | 10.10.40.0  | 2.2.2.2   | 1012 | 80000001 | 105e          |
| Global       | 0005     | 10.10.6.255 | 10.10.6.1 | 1014 | 80000001 | cb9a          |
| Area 0.0.0.0 | 0002     | 192.168.1.4 | 2.2.2.2   | 966  | 80000002 | 049b          |
| Area 0.0.0.0 | 0001     | 2.2.2.2     | 2.2.2.2   | 966  | 80000004 | 8785          |
| Area 0.0.0.0 | 0001     | 10.10.6.1   | 10.10.6.1 |      | 967      | 80000002 d25b |

### BGP

The basic BGP configuration consists of adding a neighbor entry for each peer and configuring an export filter. BGP can operate in two modes: External BGP (EBGP) and Internal (IBGP). EBGP is used between BGP routers that are in different Autonomous (AS) systems and IBGP is used between BGP routers in the same ASes (to redistribute routes learned from external BGP routers to internal BGP routers). The mode is not configured explicitly but is activated based on AS number configuration for the local BGP router and the neighbor. When the AS number is different, BGP operates in EBGP mode and when it is the same it operates in IBGP mode. In the example below, BGP is configured with one external neighbor with LOCAL\_LAN as the export filter.

Navigate to **Routing->Basic Config->BGP**

Select 'LOCAL\_LAN' as the export filter.





▼ BGP

Preference

### Neighbor

Search  x    Add ...    Delete   

| Name        | Peer Type | Peer Address | Local Address | Enabled | Import Filter | Export Filter |
|-------------|-----------|--------------|---------------|---------|---------------|---------------|
| PRIMARY-HUB | static    | 172.16.0.1   |               | true    |               | LOCAL_LAN     |

Showing 1 to 1 of 1

### Configure Neighbor Details

Peer Type: static

Peer Address: 172.16.0.1

Local Address:

Enabled:

Import Filter:  ...

Export Filter: LOCAL\_LAN ...

Passive:

Local As\*: 65550

Peer As\*: 65500

Link Type:  ▼

Next Hop Self:

Hold Time: 30 seconds

Keepalive Time: 10 seconds

Connect Retry Time: 120 seconds

To apply configuration, click **Save**.

---

**NOTE** Please see section 12.2.2.1 for an example on use of BGP to exchange routes over DMVPN network.

---

## Using CLI

In **configuration** mode, enter following commands:

```
% set routing bgp neighbor PRIMARY-HUB peer-address 172.16.0.1
```

```
% set routing bgp neighbor PRIMARY-HUB enabled true
```



```
% set routing bgp neighbor PRIMARY-HUB export-filter LOCAL_LAN
% set routing bgp neighbor PRIMARY-HUB local-as 65550
% set routing bgp neighbor PRIMARY-HUB peer-as 65500
% set routing bgp neighbor PRIMARY-HUB hold-time 30
% set routing bgp neighbor PRIMARY-HUB keepalive-time 10
```

## Monitoring

Navigate to *Routing-> Status*

The user can check the routing table in the 'General' panel to ensure a dynamic route for the back-office has been received from the back-office router.

▼ BGP

### Neighbor

Search x

📶 🔄 👁 🔍 ✎

| Name        | Routing Instance | State | Preference | Import Filter | Export Filter | Statistics - Import Updates Received |
|-------------|------------------|-------|------------|---------------|---------------|--------------------------------------|
| PRIMARY-HUB | inet.main        | up    | 100        | ACCEPT        | LOCAL-LAN     | 1                                    |

Showing 1 to 1 of 1

### Neighbor Details

- ⓘ Routing Instance: inet.main
- ⓘ State: up
- ⓘ Preference: 100
- ⓘ Import Filter: ACCEPT
- ⓘ Export Filter: LOCAL-LAN

#### Statistics

- ⓘ Import Updates Received: 1

- ⓘ Local State: established
- ⓘ Peer Address: 172.16.0.1
- ⓘ Peer As: 65500
- ⓘ Peer ID: 172.16.0.1
- ⓘ Local Address: 172.16.0.3
- ⓘ Hold Time: 15/30
- ⓘ Keepalive Time: 5/10

Finish

## Using CLI

In **operational** mode, enter following commands:

```
>show routing-state bgp
```



```
routing-state bgp neighbor PRIMARY-HUB
routing-instance inet.main
state      up
preference      100
import-filter  ACCEPT
export-filter   LOCAL-LAN
statistics import-updates-received 1
statistics import-updates-rejected 0
statistics import-updates-filtered 0
statistics import-updates-ignored 0
statistics import-updates-accepted 1
statistics import-withdraws-received 0
statistics import-withdraws-rejected 0
statistics import-withdraws-ignored 0
statistics import-withdraws-accepted 0
statistics export-updates-received 8
statistics export-updates-rejected 1
statistics export-updates-filtered 6
statistics export-updates-accepted 1
statistics export-withdraws-received 0
statistics export-withdraws-accepted 0
local-state  established
peer-address 172.16.0.1
peer-as      65500
peer-id      172.16.0.1
local-address 172.16.0.3
hold-time    23/30
keepalive-time 7/10
```

### 3.8.22 GPS Service

#### Understanding

A unit may be equipped with internal GPS support. The GPS service obtains location information from the GPS sources in the system and makes it available as status data to all northbound management interfaces like CLI/SSH, NETCONF, SNMP and WebUI. As of this writing, GPS service supports following data sources on MCR and ECR:

- Standalone GPS receiver in 4G cellular modules (4Gx in the model string).

The following table below displays the approved GPS antennas that can be used.

Table 3-22. Approved GPS Antenna Types



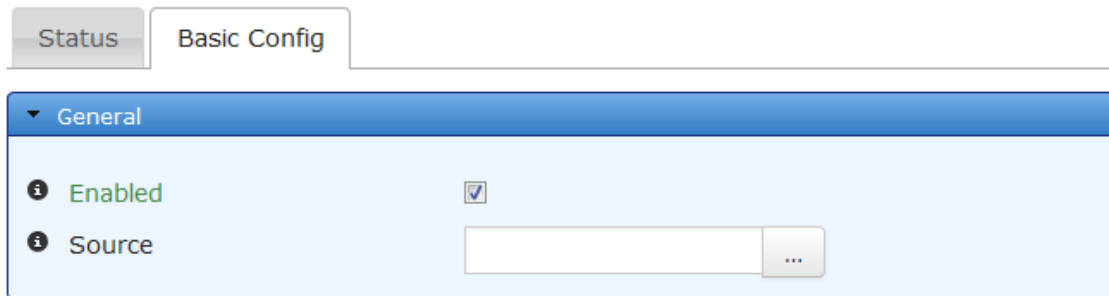
| Application | Location | Frequency Range | Gain | Antenna Description | GE MDS Part Number |
|-------------|----------|-----------------|------|---------------------|--------------------|
| GPS         |          |                 |      |                     | 97-3194A25         |
| GPS         |          |                 |      |                     | 97-3194A33         |

**NOTE** A GPS equipped unit has a dedicated GPS antenna port which provides 3.3V, 100mA max DC bias and can be used with active GPS antennas.

## Configuring

Navigate to *Services->GPS Service--> Basic Config*

### GPS Service



The screenshot shows the 'GPS Service' configuration page. At the top, there are two tabs: 'Status' and 'Basic Config'. The 'Basic Config' tab is active. Below the tabs is a 'General' section with a blue header. Inside this section, there are two rows of configuration options. The first row is 'Enabled', which has a green checkmark and a small square icon to its right. The second row is 'Source', which has a text input field and a small square icon with three dots to its right.

The GPS service has very minimal configuration. The user simply has to enable the GPS service for it to start collecting data from the first detected GPS data source in the system. If there are more sources in the system, then user can select the specific data source by configuring the ‘source’ parameter.

To apply configuration, click **Save**.

## Using CLI

```
% set services gps enabled true
% commit
```

## Monitoring

Navigate to *Services --> GPS Service --> Status*



Status Basic Config Advanced Config Actions

General

Status running

Data

Fix Mode 3d-fix Refresh every seconds

Time 2015-06-08T18:24:35.000Z

Latitude 43.11788946700000

Longitude -77.61127781700000

Altitude 601.0498733520508

Speed 0.0000000000000000e+0

Heading 0.0000000000000000e+0

Sources

Sources

Name Device

|                |              |
|----------------|--------------|
| SLOT1-CELL-GPS | /dev/ttyUSB1 |
|----------------|--------------|

The 'General' panel shows the general status of the service i.e. whether it is running or not. The 'Data' panel displays the GPS location information as reported by the GPS data source. The 'Sources' panel displays the GPS data sources detected in the system. In the above example, GPS service is collecting data from the GPS receiver in the cellular module.

## Using CLI

```
> show services gps
services gps status fix-mode 3d-fix
services gps status time 2015-06-08T18:27:44.000Z
services gps status latitude 43.11787493300000
services gps status longitude -77.61123601700000
services gps status altitude 588.5826816558838
services gps status speed 0.0000000000000000e+0
services gps status heading 0.0000000000000000e+0
NAME      DEVICE
-----
SLOT1-CELL-GPS /dev/ttyUSB1
```

### 3.8.23 Dynamic DNS

#### Understanding

The unit supports Dynamic DNS (DDNS) service that enables update of the dynamic address of an interface (typically, cellular WAN interface) on the unit against a pre-registered fully qualified domain name (FQDN) (for example, pump1.dyndns.org) with a DDNS provider. The update occurs when the interface address changes as well as periodically. This enables a host or application to contact a remote unit using a fixed domain name even if the IP address of the remote unit is dynamic.

There is built in support for DynDNS.com and No-IP.com DDNS providers. The service also supports user specified URL for updating DDNS providers that do not have built-in support.

#### Configuring

Navigate to *Services->DDNS Service--> Basic Config*



## DDNS Service

| Status                    | Basic Config                        | Advanced Config | Actions |
|---------------------------|-------------------------------------|-----------------|---------|
| <b>General</b>            |                                     |                 |         |
| Enabled                   | <input checked="" type="checkbox"/> |                 |         |
| Provider                  | dyn.com                             |                 |         |
| Hostname                  | pump1.dyndns.org                    |                 |         |
| Username                  | test                                |                 |         |
| Password                  | ••••••                              |                 |         |
| Interface                 | Cell                                |                 |         |
| Update Interval           | 1440                                |                 |         |
| Failure Retry Interval    | 5                                   |                 |         |
| Max Failure Retries       | 6                                   |                 |         |
| Https                     | <input type="checkbox"/>            |                 |         |
| Verify Server Certificate | <input type="checkbox"/>            |                 |         |
| CA Certificate            |                                     |                 |         |

- **Provider** – The DDNS service provider .
- **Hostname** – The fully qualified domain name (FQDN) for the unit.
- **Username** – The username for the DDNS service provider account.
- **Password**- The password for the DDNS service provider account.
- **Interface** – The interface whose dynamic IP address needs to be registered with the DDNS service provider.
- **Update Interval** – The interval, in minutes, at which periodic update interval will occur.
- **Failure Retry Interval** – The interval, in seconds, at which retries will occur if connection cannot be made to DDNS service provider.
- **Max Failure Retries** –The maximum number of times to retry connecting to the DDNS service provider for an update.
- **HTTPS** – Whether or not to use HTTPS when sending DDNS updates.
- **Verify Server Certificate** – Whether or not to verify DDNS service provider.
- **CA Certificate** – Locally stored certificate to use to verify DDNS service provider.



For DDNS service providers other than ‘dyn.com’ and ‘no-ip.com’, the user can choose ‘Other’ as the DDNS service provider and enter the URL to which DDNS updates should be posted. Each DDNS service provider has different URL format but with following common fields:

- Username
- Password
- Hostname
- IP address

For example, if service provider XYZ has following format for posting update for hostname=pump1.xyz.com with IP address 1.1.1.1 and with username=test and password=test123:

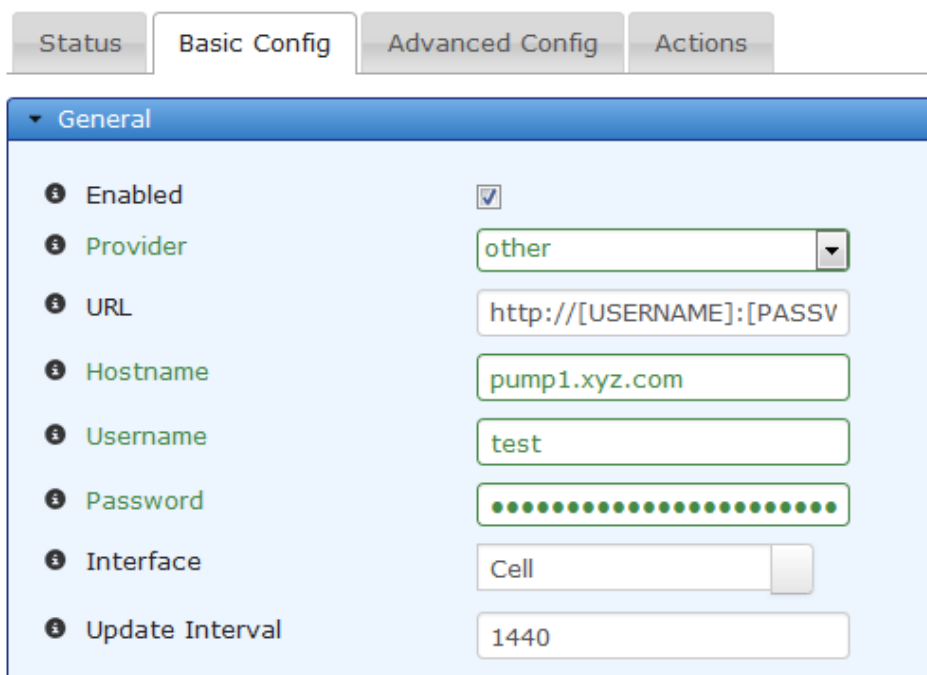
<http://test:test123@xyz.com/update?hostname=pump1.xyz.com&myip=1.1.1.1>

Then, user should enter following in the URL field:

[http://\[USERNAME\]:\[PASSWORD\]@xyz.com/update?hostname=\[HOSTNAME\]&myip=\[IP\]](http://[USERNAME]:[PASSWORD]@xyz.com/update?hostname=[HOSTNAME]&myip=[IP])

The username, password, hostname fields will be replaced with those configured when posting the DDNS update along with dynamic IP address of the configured interface.

## DDNS Service



| Field           | Value                               |
|-----------------|-------------------------------------|
| Enabled         | <input checked="" type="checkbox"/> |
| Provider        | other                               |
| URL             | http://[USERNAME]:[PASSV]           |
| Hostname        | pump1.xyz.com                       |
| Username        | test                                |
| Password        | .....                               |
| Interface       | Cell                                |
| Update Interval | 1440                                |

**NOTE** In firmware versions prior to 4.x.x, the user might need to click the refresh symbol next to ‘DDNS service’ to make the URL field show up after Provider = ‘Other’ is selected.

To apply configuration, click **Save**.

### Using CLI

```
% set services ddns enabled true
% set services ddns provider dyn.com
% set services ddns hostname pump1.dyndns.org
% set services ddns username test
% set services ddns password test123
% set services ddns interface Cell
```



% commit

## Monitoring

Navigate to *Services--> DDNS Service--> Status*

### DDNS Service

| Status                                                                                                                                                                                                                                                                                                                                               | Basic Config                     | Advanced Config | Actions |          |         |                |         |                         |  |                    |                                  |
|------------------------------------------------------------------------------------------------------------------------------------------------------------------------------------------------------------------------------------------------------------------------------------------------------------------------------------------------------|----------------------------------|-----------------|---------|----------|---------|----------------|---------|-------------------------|--|--------------------|----------------------------------|
| <div style="background-color: #e6f2ff; padding: 5px;"> <p>▼ General</p> <table border="0"> <tr> <td>ⓘ Status</td> <td>running</td> </tr> <tr> <td>ⓘ Update State</td> <td>success</td> </tr> <tr> <td>ⓘ Update Failure Reason</td> <td></td> </tr> <tr> <td>ⓘ Update Timestamp</td> <td>Tue, 01 Jan 2013<br/>07:43:00 GMT</td> </tr> </table> </div> |                                  |                 |         | ⓘ Status | running | ⓘ Update State | success | ⓘ Update Failure Reason |  | ⓘ Update Timestamp | Tue, 01 Jan 2013<br>07:43:00 GMT |
| ⓘ Status                                                                                                                                                                                                                                                                                                                                             | running                          |                 |         |          |         |                |         |                         |  |                    |                                  |
| ⓘ Update State                                                                                                                                                                                                                                                                                                                                       | success                          |                 |         |          |         |                |         |                         |  |                    |                                  |
| ⓘ Update Failure Reason                                                                                                                                                                                                                                                                                                                              |                                  |                 |         |          |         |                |         |                         |  |                    |                                  |
| ⓘ Update Timestamp                                                                                                                                                                                                                                                                                                                                   | Tue, 01 Jan 2013<br>07:43:00 GMT |                 |         |          |         |                |         |                         |  |                    |                                  |

- **Status** - Indicates whether the service is enabled/running.
- **Update State**- Current state of DDNS update operation.
- **Update failure reason** – A message indicating the reason for a failed DDNS update.
- **Update Timestamp** – The timestamp of last update.

## Using CLI

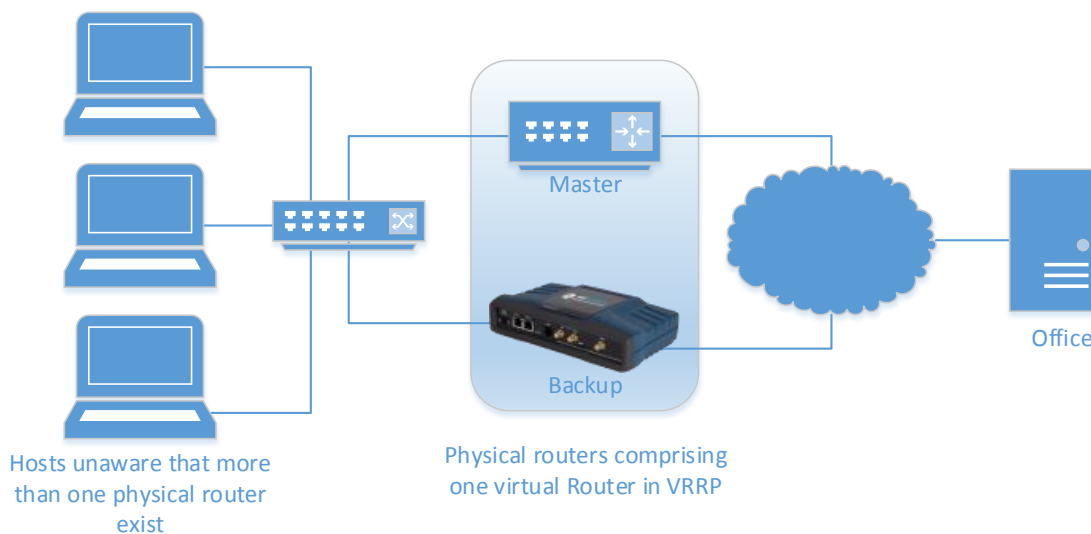
```
> show services ddns
services ddns status update-state success
services ddns status update-failure-reason ""
services ddns status update-timestamp 2013-01-01T07:43:00+00:00
```

## 3.8.24 VRRP – Virtual Router Redundancy Protocol

### Understanding

VRRP is a method of setting up multiple routers to provide redundant routing capability. It is defined in the IETF RFC5798. In VRRP, a group of physical routers are configured similarly with VRRP settings and together they act as one virtual router on the network. Only one physical router is negotiated as the Master router at a time; the remaining routers act as Backup until it has been determined that the Master has gone offline. This failover mechanism is automatic and built into VRRP. The group collectively uses the same Virtual IP (VIP), but it is only active on the Master at any given time. When failover occurs, the next negotiated router becomes the Master and assumes the VIP. This provides reliable network connectivity and simplifies configuration of hosts on the network. The hosts need to be configured to communicate to only one router IP address, the VIP, and whichever physical router is currently designated as the Master will have that VIP address assigned to its interface.





## Configuration

VRRP can be enabled on select interfaces, including Ethernet, Bridge, and VLAN interfaces. For example:

**configure**

```
%set interfaces interface ETH2 vrrp address 192.168.1.1 subnet-mask 255.255.255.0 id 1
priority 100
```

The following items are configurable VRRP settings for each interface:

- **enabled** – whether or not VRRP is enabled on the interface
- **address** – the Virtual IP (VIP) assigned to the physical routers in a VRRP group.
- **subnet-mask** – corresponding subnet-mask to the VIP
- **id** – a numeric value that indicates which VRRP group this router belongs to.
- **priority** – each physical router in a group gets its own priority. The higher the number, the higher the priority that the physical router will be become the Master during negotiation.
- **advertisement-interval** – The Master router advertises its presence to the Backups. This controls the frequency of those advertisements.
- **preemption** – whether or not to allow higher priority routers become Master when they come online.

All physical routers in a VRRP group must be configured with same VIP address/subnet and id. Each router should have a unique priority value. Lastly, each router could have an additional, unique, IP/subnet on the same interface that VRRP is running on to facilitate administration and diagnostics.

## Monitoring

Read-only parameters for interfaces with VRRP show the state of the router:

```
show interfaces-state interface ETH2 vrrp
```

The router status will be displayed as one of the following states:

- **vrrp disabled** – VRRP is disabled on this interface.
- **vrrp initializing** – VRRP is starting.



**vrrp master** – This interface is acting as the Master router. It will have the VIP/subnet applied to it and will be routing traffic.

**vrrp backup** – This interface is acting as one of the Backup routers. It will not have the VIP/subnet applied to it and will not be routing traffic.

### 3.8.25 IP Passthrough

#### Understanding

This service enables an outside interface's (e.g. Cell) IP address to be passed through to a device connected to an inside interface (e.g. Bridge) of Orbit, making Orbit act as a simple modem (like a traditional cable modem). The pass through service also enables user to configure certain traffic to be terminated at Orbit (for example, management) instead getting passed through. This service is typically used for Orbit devices with cellular interfaces where the Orbit is connected to the end-device via LAN and the IP address received from the cellular network needs to be passed to the end-device so it can be accessed using that address from the network.

#### Configuration

##### Using Web UI

Navigate to *Services->IP Passthrough->Basic Config*.

Click 'Enable' to enable the passthrough service.

The screenshot displays the 'IP Passthrough Service' configuration page. On the left is a navigation menu with 'Services' expanded to show various services, including 'IP Passthrough'. The main content area has two tabs: 'Status' and 'Basic Config'. Under the 'Basic Config' tab, the 'General' section is expanded. It contains the following settings: 'Enabled' (checked), 'From Interface' (Cell), and 'To Interface' (Bridge). Below these is the 'Local Service' section, which includes a search bar, 'Add ...' and 'Delete' buttons, and a table with columns for 'Name', 'Protocol', and 'Port'. The table is currently empty, with the text 'Table is empty' at the bottom right.

Add any local service that needs to be captured and terminated at the Orbit itself instead of getting passed through to the attached end-device. This is typically required to enable remote management of Orbit itself. The example below shows, SSH service being added as a local service. With this configuration any traffic destined for the cellular address on port 22 will be routed to Orbit instead of getting passed through to the end device. One can similarly configure entries for HTTP (TCP port 80) or HTTPS (tcp port 443) to enable remote access to Orbit's Web UI.



### Local Service

Search  x Add ... Delete Signal Refresh Eye Search Tools

| Name | Protocol | Port |
|------|----------|------|
| SSH  | tcp      | 22   |

Showing 1 to 1 of 1

#### Configure Local Service Details

**Protocol\***

**Port\***

Finish

To apply configuration, click **Save**.

### Using CLI

In configuration mode, enter following commands:

```
% set services ip-passthrough enabled true
% set services ip-passthrough local-service SSH protocol tcp port 22
% set services ip-passthrough local-service HTTP protocol tcp port 80
% set services ip-passthrough local-service HTTPS protocol tcp port 443
% commit
```

### Monitoring

#### Using Web UI

Navigate to *Services->IP Passthrough->Status*

## IP Passthrough Service

Status Basic Config

▼ General

|               |         |
|---------------|---------|
| <b>Status</b> | running |
|---------------|---------|



## 3.9 Public Key and Certificates

### 3.9.1 Certificate Management and 802.1X Authentication

#### Understanding

A RADIUS server can be configured for 802.1X device authentication on the on the Orbit MCR; WPA/WPA2-Enterprise privacy mode on the Wi-Fi or EAP security mode on the NX915 and LNxxx radio interfaces.

The device uses x509 public certificates and private keys for the following services:

- Secure Reprogramming
- Syslog over TLS
- IPsec VPN/IMA (when using pub-key, EAP-TLS or EAP-TTLS based authentication)
- WiFi (when doing EAP-TLS authentication in station mode)
- NxRadio (when **security-mode** is set to *EAP* on Remote units)

Certificates can be imported into the device using one of two methods: manually or via SCEP. Note that certificates for secure reprogramming can only be imported using the manual method.

The device can import certificates that are in DER, PEM, or encrypted PEM format. The device can import private keys that are in DER, PEM or encrypted PEM.

#### 3.9.2 Private Keys

The device can manually import private keys, or can generate a new private key of a specified length.

From the WebUI, navigate to *Certificate Management / Basic Config*. The **Private Keys** section shows the private keys currently loaded into the device.

#### Certificate Management ↕

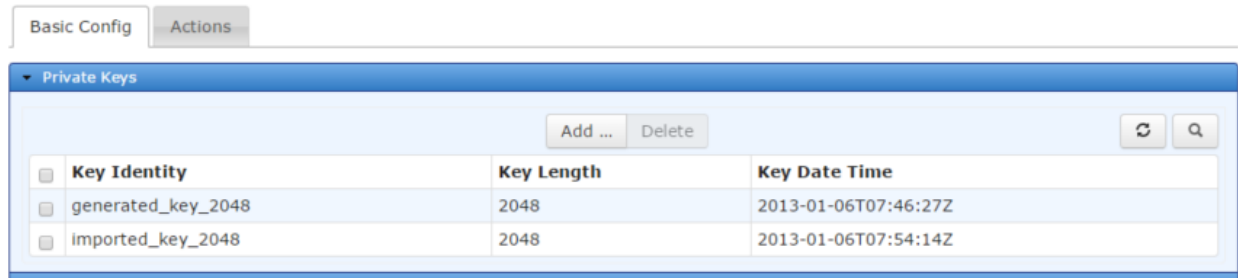


Figure 3-229. Private Keys

Ensure the CLI is in operational mode and follow the example below to view installed private keys:

```
> show pki private-keys show-all
```

| KEY IDENTITY       | KEY LENGTH | KEY DATE TIME        |
|--------------------|------------|----------------------|
| generated_key_2048 | 2048       | 2013-01-06T07:46:27Z |
| imported_key_2048  | 2048       | 2013-01-06T07:54:14Z |

#### Deleting

The device may delete a private key by clicking the **Delete** button on the web user interface or using the CLI in operational mode. See the following example for deleting private keys via the CLI:

```
> request pki private-keys delete key-identity generated_key_2048
```



## Configuring - Generation

To start generating a new private key, navigate to *System / Certificate Management ---> Actions / Generate Private Key*. Click on the **Begin Generation** button once the key identity and key size (in bits) is configured.

### Certificate Management

Basic Config Actions

Generate Private Key

**Generate Private Key**

Key Identity \* generated\_key\_2048

Key Size \* 2048

1024

1536

2048

3072

4096

Begin Generation

Figure 3-230. Generate Private Key

The device requires two parameters when generating a new private key.

- **Key Identity** - The ID to assign to the key once it is generated
- **Key Size** - The number of bits in the key. Allowed sizes include 1024, 1536, 2048, 3072, and 4096

The following example shows how to have the device generate a private key of length 2048 bits with the identity generated\_key\_2048:

```
> request pki private_keys generate key-identity generated_key_2048 key-size 2048
```

## Monitoring - Generation

Once the generation is begun, the process may be cancelled by clicking the **Cancel Generation** button. The current status of the generation process is displayed on the web page. Note that the web page does not display the current status if the device has not been instructed to generate a private key (in other words, if the state is “inactive”).

### Certificate Management

Basic Config Actions

Generate Private Key

**Generate Private Key**

Key Identity \* generated\_key\_2048

Key Size \* 2048

Begin Generation

**Generation Status**

Current State complete

Details Successfully generated private key generated\_key\_2048 with 2048 bits

Percent Complete 100%



**Figure 3-231. Generate Private Key Monitoring**

The generation status contains the following items:

- **Current State** – The status of the generation task:
  - inactive
  - processing
  - cancelling
  - complete
  - failure
  - cancelled
- **Detailed Message** – The details regarding the operation, such as “*Generating private key*”
- **Size** – The total number of bytes in the key (not displayed on the web UI)
- **Bytes Transferred** – The number of bytes already transferred or processed (not displayed on the web UI)
- **Percent Complete** – The percentage complete for the operation

To view the status of the generation process in the CLI, ensure the CLI is in operational mode and then follow the example below:

```
> show pki private-keys generate-status
pki private-keys generate-status state complete
pki private-keys generate-status detailed-message "Successfully generated private key
generated_key_2048 with 2048 bits"
pki private-keys generate-status size 256
pki private-keys generate-status bytes-transferred 256
pki private-keys generate-status percent-complete 100
```

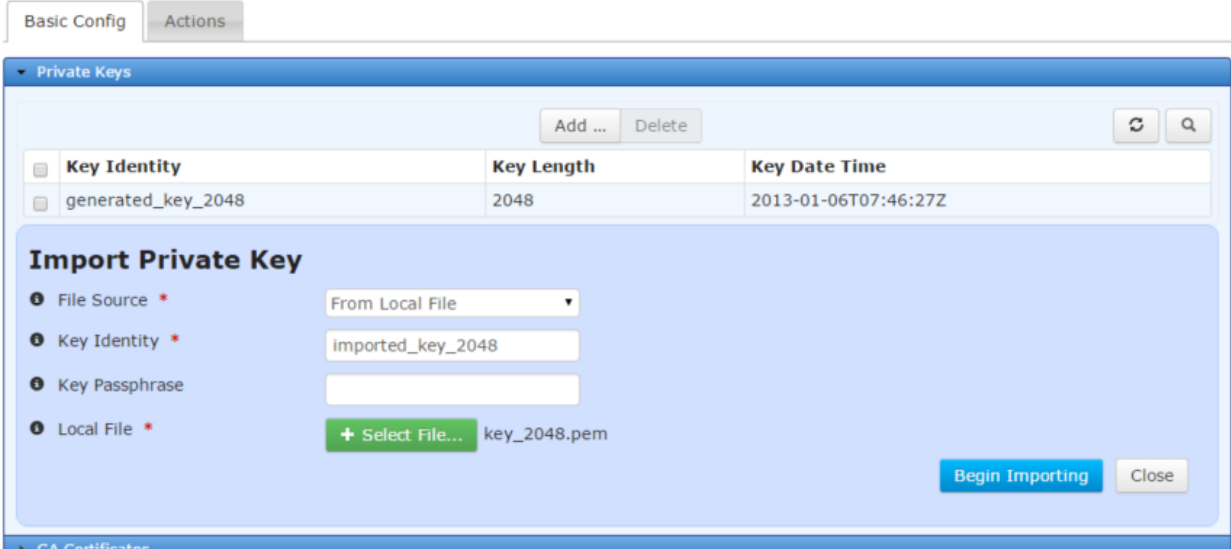
## Configuring - Import

The following example shows how to have the device import a private key by uploading a local file through the web browser.

Navigate to the **Private Keys** section in *Certificate Management / Basic Config*.

Click on the **Add** button, and then click on the **Begin Importing** button once the key identity, the optional key passphrase, and the file source are configured.

## Certificate Management



The screenshot shows the 'Certificate Management' web interface. At the top, there are tabs for 'Basic Config' and 'Actions'. Below this is a section titled 'Private Keys' with a table containing one entry: 'generated\_key\_2048' with a key length of 2048 and a key date time of 2013-01-06T07:46:27Z. Below the table is a form titled 'Import Private Key' with the following fields: 'File Source' (set to 'From Local File'), 'Key Identity' (set to 'imported\_key\_2048'), 'Key Passphrase' (empty), and 'Local File' (set to 'key\_2048.pem'). There are 'Add ...' and 'Delete' buttons at the top right of the table, and 'Begin Importing' and 'Close' buttons at the bottom right of the form.



**Figure 3-232. Import Private Key**

The MCR supports file uploads through a web browser from a local file on the user's PC. The MCR also supports HTTP, FTP, TFTP, and SFTP file downloads using external remote servers.

- **File Source** - File transfer method to use. Available choices are From Local File (DEFAULT), From HTTP Server, From FTP Server, From TFTP Server, and From SFTP Server. Local file uploads are only available through the web UI and not through the CLI
- **Key Identity** - The ID to assign to the key once it is imported
- **Key Passphrase** – For encrypted PEM keys, the passphrase necessary to decrypt the key
- **Local File** - For a local file, the file to upload as chosen by the file dialog popped up by the **Select File...** button
- **URL** - For HTTP, the location of the source file
- **Server Address** - For FTP, TFTP, and SFTP, the remote server's host name or IP address
- **File Path** - For FTP, TFTP, and SFTP, the path to the source file on the remote server
- **User Name** - For FTP and SFTP, the user name on the remote server
- **Password** - For FTP and SFTP, the password on the remote server
- **Control Port** - For FTP, the TCP control port (advanced setting - use default)
- **Data Port** - For FTP, the TCP data port (advanced setting - use default)
- **Block Size** - For TFTP, the block size as defined in RFP 2348 (advanced setting - use default)
- **Timeout** - For FTP, TFTP, and SFTP, the timeout in seconds (advanced setting - use default)

The following example shows how to have the device download a private key file (named imported\_key\_2048.pem) from a TFTP server running on a host (address 192.168.1.10) that is accessible from the MCR (e.g. a locally connected host or remote host accessible via cellular interface). To start the private key import from the CLI, enter the following command to download the private key file from the TFTP server:

```
> request pki private-keys import key-identity imported_key_2048 filename key_2048.pem  
manual-file-server { tftp { address 192.168.1.10 } }
```

## Monitoring - Import

Once the import of a private key is begun, the process may be cancelled by clicking the **Cancel Import** button. The current status of the import process is displayed on the web page. Note that the web page does not display the current status if the device has not been instructed to import a private key (in other words, if the state is “inactive”).

**Import Private Key**

File Source \*

Key Identity \*

Key Passphrase

Local File \*  key\_2048.pem

**Import Status**

Current State complete

Details Successfully imported private key

Percent Complete



**Figure 3-233. Import Private Key Monitoring**

The import status contains the following items:

- **Current State** – The status of the import task:
  - inactive
  - transferring
  - processing
  - cancelling
  - complete
  - failure
  - cancelled
- **Detailed Message** – The details regarding the operation, such as “*Transferring private key*”
- **Size** – The total number of bytes in the file (not displayed on the web UI)
- **Bytes Transferred** – The number of bytes already transferred or processed (not displayed on the web UI)
- **Percent Complete** – The percentage complete for the operation

To view the status of the import process in the CLI, ensure the CLI is in operational mode and then follow the example below:

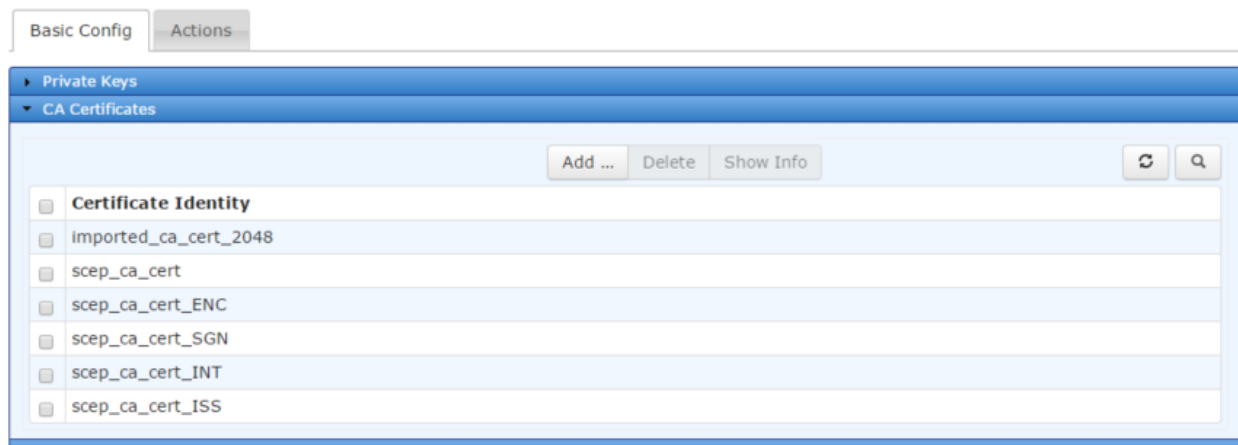
```
> show pki private-keys import-status
pki private-keys import-status state complete
pki private-keys import-status detailed-message "Successfully imported private key"
pki private-keys import-status size 1191
pki private-keys import-status bytes-transferred 1191
pki private-keys import-status percent-complete 100
```

### 3.9.3 CA Certificates

The device can manually import CA certificates or obtain them via the SCEP protocol.

From the WebUI, navigate to *Certificate Management / Basic Config*. The **CA Certificates** section shows the CA certificates currently loaded into the device.

#### Certificate Management



**Figure 3-234. CA Certificates**

Ensure the CLI is in operational mode and follow the example below to view the installed CA certificates:

```
> show pki ca-certs show-all
CERT IDENTITY
```





```
-----
imported_ca_cert_2048
scep_ca_cert
scep_ca_cert_ENC
scep_ca_cert_SGN
scep_ca_cert_INT
scep_ca_cert_ISS
```

When using the SCEP protocol, additional CA server files sent as part of the request and needed later are saved with the base name selected for the CA server and an added extension. Some of the additional files that may be added are:

- `_ENC` , SCEP encryption certificate
- `_SGN` , SCEP digital signature certificate

## Deleting

The device may delete a CA certificate by clicking the **Delete** button on the web user interface or using the CLI in operational mode. See the following example for deleting CA certificates via the CLI:

```
> request pki ca-certs delete cert-identity imported_ca_cert_2048
```

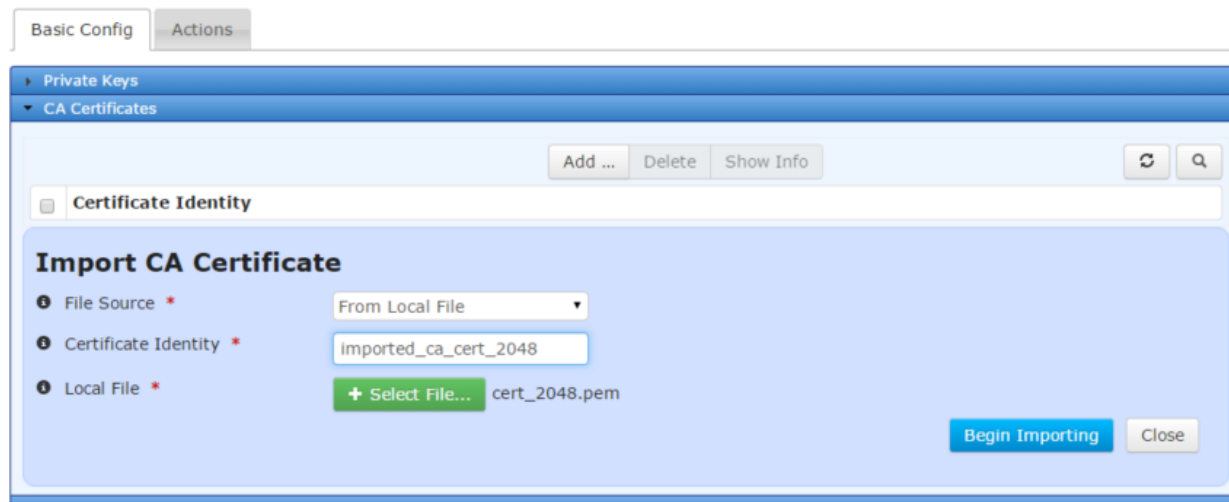
## Configuring

The following example shows how to have the device import a CA certificate by uploading a local file through the web browser.

Navigate to the **CA Certificates** section in *Certificate Management / Basic Config*.

Click on the **Add** button, and then click on the **Begin Importing** button once the certificate identity and the file source are configured.

## Certificate Management



**Figure 3-235. Import CA Certificate**

The MCR supports file uploads through a web browser from a local file on the user's PC. The MCR also supports HTTP, FTP, TFTP, SFTP, and SCEP file downloads using external remote servers.

- **File Source** - File transfer method to use. Available choices are From Local File (DEFAULT), From HTTP Server, From FTP Server, From TFTP Server, From SFTP Server, and From SCEP Server. Local file uploads are only available through the web UI and not through the CLI



- **Certificate Identity** - The ID to assign to the certificate once it is imported
- **Local File** - For a local file, the file to upload as chosen by the file dialog popped up by the **Select File...** button
- **URL** - For HTTP, the location of the source file
- **Server Address** - For FTP, TFTP, and SFTP, the remote server's host name or IP address
- **File Path** - For FTP, TFTP, and SFTP, the path to the source file on the remote server
- **User Name** - For FTP and SFTP, the user name on the remote server
- **Password** - For FTP and SFTP, the password on the remote server
- **Control Port** - For FTP, the TCP control port (advanced setting - use default)
- **Data Port** - For FTP, the TCP data port (advanced setting - use default)
- **Block Size** - For TFTP, the block size as defined in RFP 2348 (advanced setting - use default)
- **Timeout** - For FTP, TFTP, and SFTP, the timeout in seconds (advanced setting - use default)
- **Certificate Server Identity** - For SCEP, the ID of a predefined certificate server to communicate with via the SCEP protocol
- **Issuing CA Server Identity** - For SCEP, the ID of a predefined issuing CA server

The following example shows how to have the device download a CA certificate file (named `ca_cert_2048.pem`) from a TFTP server running on a host (address `192.168.1.10`) that is accessible from the MCR (e.g. a locally connected host or remote host accessible via cellular interface). To start the CA certificate import from the CLI, enter the following command to download the CA certificate file from the TFTP server:

```
> request pki ca-certs import cert-identity imported_ca_cert_2048 file { filename  
ca_cert_2048.pem manual-file-server { tftp { address 192.168.1.10 } } }
```

The following example shows how to have the device download a CA certificate file (named `ca_cert_2048.pem`) from a predefined SCEP server that is accessible from the MCR (e.g. a locally connected host or remote host accessible via cellular interface). To start the CA certificate import from the CLI, enter the following command to download the CA certificate file from the SCEP server:

```
> request pki ca-certs import cert-identity scep_ca_cert scep {  
ca-issuer-identity predefined_ca_server cert-server-identity predefined_cert_server }
```

## Monitoring - Import

Once the import of a CA certificate is begun, the process may be cancelled by clicking the **Cancel Import** button. The current status of the import process is displayed on the web page. Note that the web page does not display the current status if the device has not been instructed to import a CA certificate (in other words, if the state is “inactive”).

**Import CA Certificate**

File Source \*

Certificate Identity \*

Local File \*

**Import Status**

Current State

Details

Percent Complete



**Figure 3-236. Import CA Certificate Monitoring**

The import status contains the following items:

- **Current State** – The status of the import task:
  - inactive
  - transferring
  - processing
  - cancelling
  - complete
  - failure
  - cancelled
- **Detailed Message** – The details regarding the operation, such as “*Transferring CA certificate*”
- **Size** – The total number of bytes in the file (not displayed on the web UI)
- **Bytes Transferred** – The number of bytes already transferred or processed (not displayed on the web UI)
- **Percent Complete** – The percentage complete for the operation

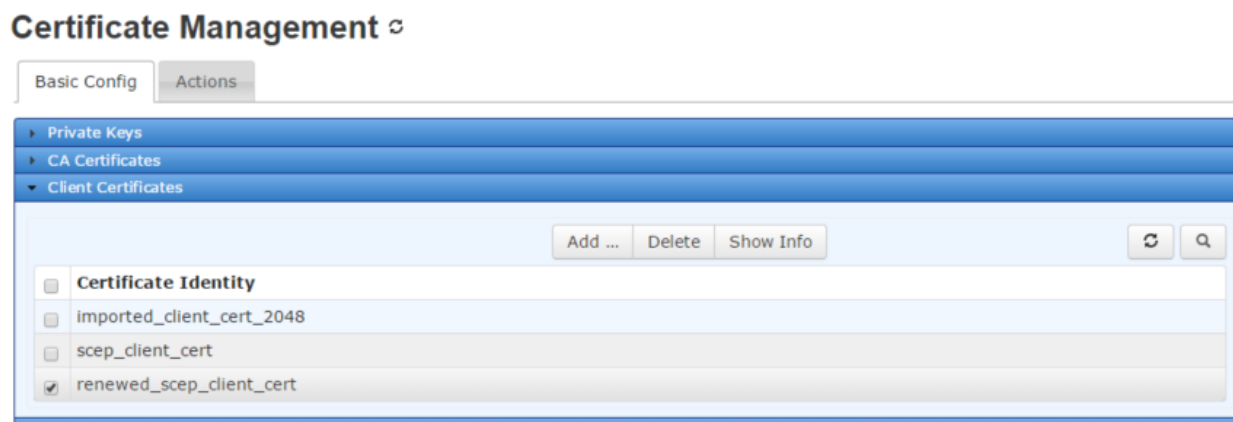
To view the status of the import process in the CLI, ensure the CLI is in operational mode and then follow the example below:

```
> show pki ca-certs import-status
pki ca-certs import-status state complete
pki ca-certs import-status detailed-message "Successfully imported CA certificate"
pki ca-certs import-status size 1586
pki ca-certs import-status bytes-transferred 1586
pki ca-certs import-status percent-complete 100
```

### 3.9.4 Client Certificates

The device can manually import client certificates or obtain them via the SCEP protocol. When obtaining a client certificate via the SCEP protocol, the SCEP server may be instructed to return a new certificate or renew an existing certificate.

From the WebUI, navigate to *Certificate Management / Basic Config*. The **Client Certificates** section shows the client certificates currently loaded into the device.



**Figure 3-237. Client Certificates**

Ensure the CLI is in operational mode and follow the example below to view the installed client certificates:



```
> show pki client-certs show-all
CERT IDENTITY
-----
imported_client_cert_2048
scep_client_cert
renewed_scep_client_cert
```

## Deleting

The device may delete a client certificate by clicking the **Delete** button on the web user interface or using the CLI in operational mode. See the following example for deleting CA certificates via the CLI:

```
> request pki client-certs delete cert-identity imported_client_cert_2048
```

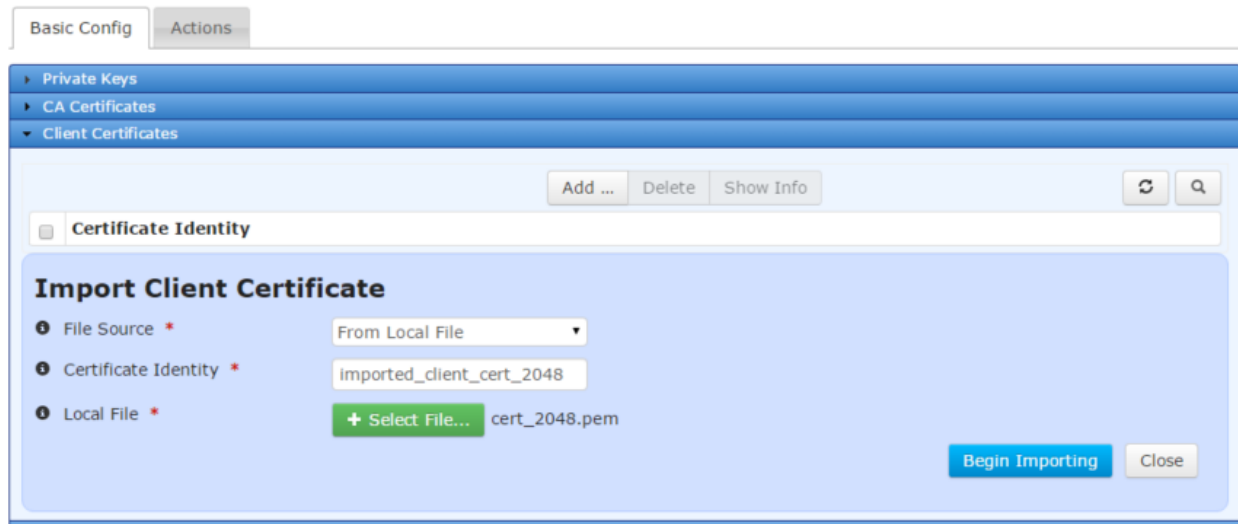
## Configuring

The following example shows how to have the device import a client certificate by uploading a local file through the web browser.

Navigate to the **Client Certificates** section in *Certificate Management / Basic Config*.

Click on the **Add** button, and then click on the **Begin Importing** button once the certificate identity and the file source are configured.

## Certificate Management



**Figure 3-238. Import Client Certificate**

The MCR supports file uploads through a web browser from a local file on the user's PC. The MCR also supports HTTP, FTP, TFTP, SFTP, and SCEP file downloads using external remote servers.

- **File Source** - File transfer method to use. Available choices are From Local File (DEFAULT), From HTTP Server, From FTP Server, From TFTP Server, From SFTP Server, and From SCEP Server. Local file uploads are only available through the web UI and not through the CLI
- **Certificate Identity** - The ID to assign to the certificate once it is imported
- **Local File** - For a local file, the file to upload as chosen by the file dialog popped up by the **Select File...** button
- **URL** - For HTTP, the location of the source file
- **Server Address** - For FTP, TFTP, and SFTP, the remote server's host name or IP address
- **File Path** - For FTP, TFTP, and SFTP, the path to the source file on the remote server



- **User Name** - For FTP and SFTP, the user name on the remote server
- **Password** - For FTP and SFTP, the password on the remote server
- **Control Port** - For FTP, the TCP control port (advanced setting - use default)
- **Data Port** - For FTP, the TCP data port (advanced setting - use default)
- **Block Size** - For TFTP, the block size as defined in RFP 2348 (advanced setting - use default)
- **Timeout** - For FTP, TFTP, and SFTP, the timeout in seconds (advanced setting - use default)
- **Certificate Server Identity** – For SCEP, the ID of a predefined certificate server to communicate with via the SCEP protocol
- **Issuing CA Server Identity** - For SCEP, the ID of a predefined issuing CA server
- **Certificate Info Identity** - For SCEP, the ID of a predefined set of certificate information used as the source for the common X.509 fields, such as country and locale
- **Key Identity** - For SCEP, the ID of an existing private key used to create the certificate
- **Import Intent** - For SCEP, determines whether to create a new certificate or renew an existing certificate
- **CA Challenge String** - For SCEP when creating a new certificate, the challenge string from the CA server that must be provided as part of the new client certificate request
- **Existing Certificate Identity** - For SCEP when renewing an existing certificate, the identity of the existing client certificate
- **Existing Key Identity** - For SCEP when renewing an existing certificate, the identity of the private key used to create the existing client certificate

The following example shows how to have the device download a client certificate file (named cert\_2048.pem) from a TFTP server running on a host (address 192.168.1.10) that is accessible from the MCR (e.g. a locally connected host or remote host accessible via cellular interface). To start the client certificate import from the CLI, enter the following command to download the client certificate from the TFTP server:

```
> request pki client-certs import cert-identity scep_client_cert scep { filename cert_2048.pem  
manual-file-server { tftp { address 192.168.1.10 } } }
```

The following example shows how to have the device import a new client certificate from a predefined SCEP server that is accessible from the MCR (e.g. a locally connected host or remote host accessible via cellular interface). To start the client certificate import from the CLI, enter the following command to download the new client certificate from the SCEP server:

```
> request pki client-certs import cert-identity scep_client_cert scep {  
cert-server-identity predefined_cert_server ca-issuer-identity predefined_ca_server cert-info-  
identity predefined_cert_info ca-cert-identity scep_ca_cert private-key-identity  
imported_key_2048 ca-challenge 36DE2A1E53BECF9AE5BB3E0B12D4C85E }
```

The following example shows how to have the device import a renewed client certificate from a predefined SCEP server that is accessible from the MCR (e.g. a locally connected host or remote host accessible via cellular interface). To start the client certificate import from the CLI, enter the following command to download the renewed client certificate from the SCEP server:

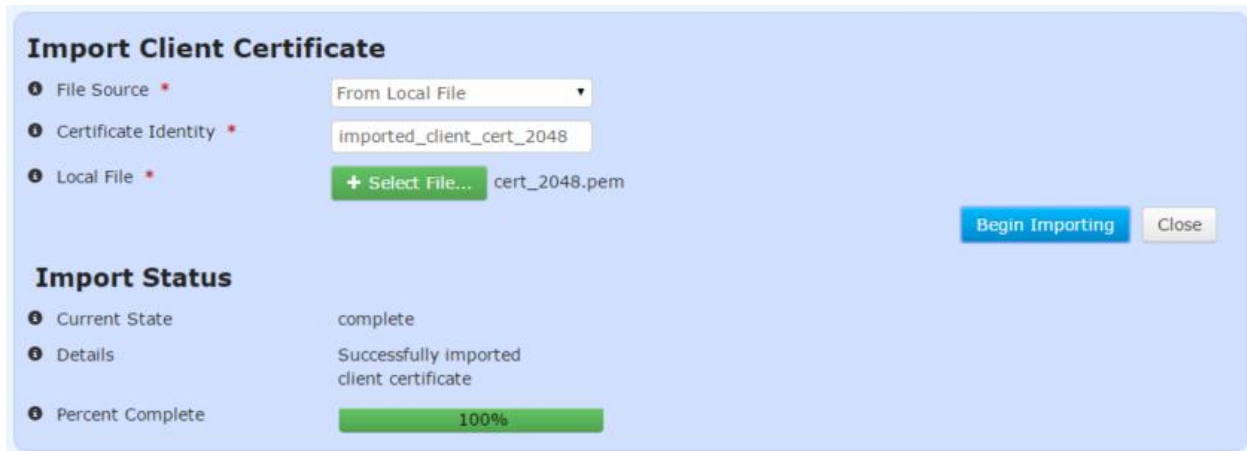
```
> request pki client-certs import cert-identity renewed_scep_client_cert scep { cert-server-  
identity predefined_cert_server ca-issuer-identity predefined_ca_server cert-info-identity  
predefined_cert_info ca-cert-identity scep_ca_cert private-key-identity imported_key_2048  
existing-cert-identity scep_client_cert existing-private-key-identity imported_key_2048 }
```

## Monitoring - Import

Once the import of a client certificate is begun, the process may be cancelled by clicking the **Cancel Import** button. The current status of the import process is displayed on the web page. Note that the web



page does not display the current status if the device has not been instructed to import a CA certificate (in other words, if the state is “inactive”).



**Figure 3-239. Import Client Certificate Monitoring**

The import status contains the following items:

- **Current State** – The status of the import task:
  - inactive
  - transferring
  - processing
  - cancelling
  - complete
  - failure
  - cancelled
- **Detailed Message** – The details regarding the operation, such as “*Transferring client certificate*”
- **Size** – The total number of bytes in the file (not displayed on the web UI)
- **Bytes Transferred** – The number of bytes already transferred or processed (not displayed on the web UI)
- **Percent Complete** – The percentage complete for the operation

To view the status of the import process in the CLI, ensure the CLI is in operational mode and then follow the example below:

```
> show pki client-certs import-status
pki client-certs import-status state complete
pki client-certs import-status detailed-message "Successfully imported client certificate"
pki client-certs import-status size 1586
pki client-certs import-status bytes-transferred 1586
pki client-certs import-status percent-complete 100
```

For SCEP imports, additional status is displayed in the web page:

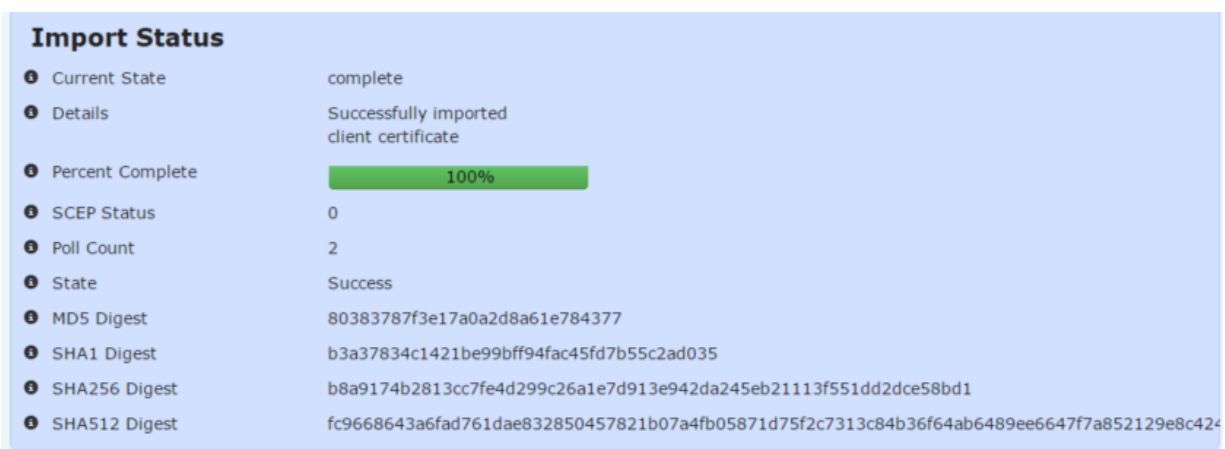


Figure 3-240. Import Client Certificate via SCEP Monitoring

The additional status related to SCEP contains the following items:

- **SCEP Status** – The last status returned from the SCEP server
- **Poll Count** – The number of times the SCEP server has been polled for completion
- **State** – The state of the SCEP transfer
- **MD5 Digest** – The SCEP request’s MD5 digest
- **SHA1 Digest** – The SCEP request’s SHA1 digest
- **SHA256 Digest** – The SCEP request’s SHA256 digest
- **SHA512 Digest** – The SCEP request’s SHA512 digest

To view the status of the import process in the CLI, ensure the CLI is in operational mode and then follow the example below:

```
> show pki client-certs import-scep-status
pki client-certs import-scep-status last-status 0
pki client-certs import-scep-status poll-count 2
pki client-certs import-scep-status state Success
pki client-certs import-scep-status req-fp-md5 80383787f3e17a0a2d8a61e784377
pki client-certs import-scep-status req-fp-sha1
b3a37834c1421be99bff94fac45fd7b55c2ad035
pki client-certs import-scep-status req-fp-sha256
b8a9174b2813cc7fe4d299c26a1e7d913e942da245eb21113f551dd2dce58bd1
pki client-certs import-scep-status req-fp-sha512
fc9668643a6fad761dae832850457821b07a4fb05871d75f2c7313c84b36f64ab6489ee6647f
7a852129e8c42474ae4af4eab46658cba2fe73308f79b632
```

### 3.9.5 Firmware Certificates

The device can manually import firmware certificates.

From the WebUI, navigate to *Certificate Management / Basic Config*. The **Firmware Certificates** section shows the firmware certificates currently loaded into the device.



## Certificate Management

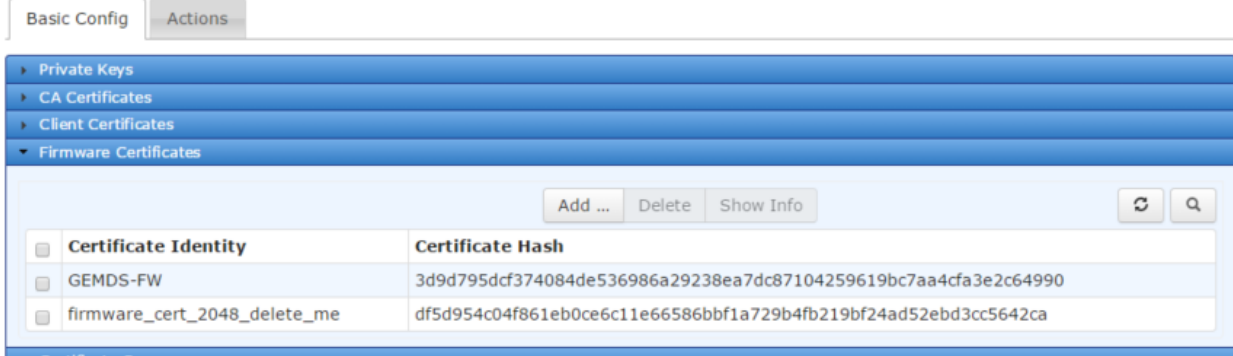


Figure 3-241. Firmware Certificates

Ensure the CLI is in operational mode and follow the example below to view the installed firmware certificates:

```
> show pki firmware-certs show-all
```

```

CERT IDENTITY          CERT HASH
-----
GEMDS-FW               3d9d795dcf374084de536986a29238ea7dc87104259619bc7aa4cfa3e2c64990
firmware_cert_2048_delete_me  df5d954c04f861eb0ce6c11e66586bbf1a729b4fb219bf24ad52ebd3cc5642ca

```

### Deleting

The device may delete a firmware certificate by clicking the **Delete** button on the web user interface or using the CLI in operational mode. See the following example for deleting CA certificates via the CLI:

```
> request pki firmware-certs delete cert-identity firmware_cert_2048_delete_me
```

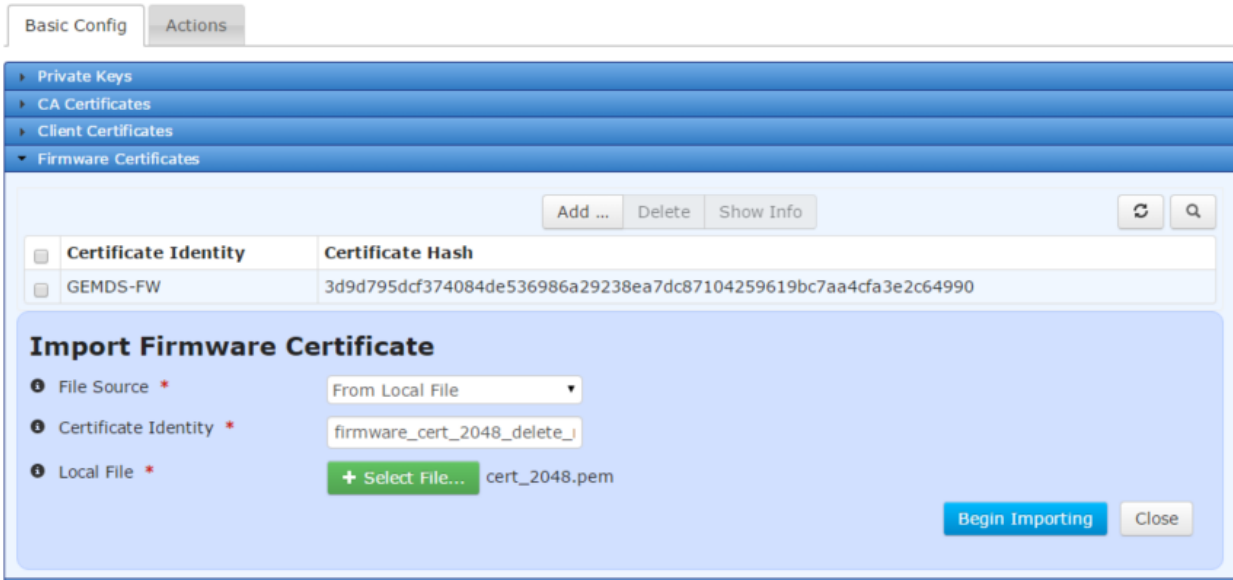
### Configuring

The following example shows how to have the device import a firmware certificate by uploading a local file through the web browser.

Navigate to the **Firmware Certificates** section in *Certificate Management / Basic Config*.

Click on the **Add** button, and then click on the **Begin Importing** button once the certificate identity and the file source are configured.

## Certificate Management







**Figure 3-242. Import Firmware Certificate**

The MCR supports file uploads through a web browser from a local file on the user's PC. The MCR also supports HTTP, FTP, TFTP, and SFTP file downloads using external remote servers.

- **File Source** - File transfer method to use. Available choices are From Local File (DEFAULT), From HTTP Server, From FTP Server, From TFTP Server, and From SFTP Server. Local file uploads are only available through the web UI and not through the CLI
- **Certificate Identity** - The ID to assign to the certificate once it is imported
- **Local File** - For a local file, the file to upload as chosen by the file dialog popped up by the **Select File...** button
- **URL** - For HTTP, the location of the source file
- **Server Address** - For FTP, TFTP, and SFTP, the remote server's host name or IP address
- **File Path** - For FTP, TFTP, and SFTP, the path to the source file on the remote server
- **User Name** - For FTP and SFTP, the user name on the remote server
- **Password** - For FTP and SFTP, the password on the remote server
- **Control Port** - For FTP, the TCP control port (advanced setting - use default)
- **Data Port** - For FTP, the TCP data port (advanced setting - use default)
- **Block Size** - For TFTP, the block size as defined in RFP 2348 (advanced setting - use default)
- **Timeout** - For FTP, TFTP, and SFTP, the timeout in seconds (advanced setting - use default)

The following example shows how to have the device download a firmware certificate file (named `firmware_cert_2048.pem`) from a TFTP server running on a host (address `192.168.1.10`) that is accessible from the MCR (e.g. a locally connected host or remote host accessible via cellular interface). To start the firmware certificate import from the CLI, enter the following command to download the firmware certificate file from the TFTP server:

```
> request pki firmware-certs import cert-identity firmware_cert_2048 filename  
firmware_cert_2048.pem manual-file-server { tftp { address 192.168.1.10 } }
```

## Monitoring - Import

Once the import of a firmware certificate is begun, the process may be cancelled by clicking the **Cancel Import** button. The current status of the import process is displayed on the web page. Note that the web page does not display the current status if the device has not been instructed to import a firmware certificate (in other words, if the state is "inactive").

The screenshot shows a web interface titled "Import Firmware Certificate". It has three input fields: "File Source" set to "From Local File", "Certificate Identity" set to "firmware\_cert\_2048\_delete\_", and "Local File" with a green "+ Select File..." button and the filename "cert\_2048.pem". There are "Begin Importing" and "Close" buttons. Below is an "Import Status" section with three items: "Current State" is "complete", "Details" is "Successfully imported firmware certificate", and "Percent Complete" is a green progress bar at "100%".

**Figure 3-243. Import Firmware Certificate Monitoring**

The import status contains the following items:



- **Current State** – The status of the import task:
  - inactive
  - transferring
  - processing
  - cancelling
  - complete
  - failure
  - cancelled
- **Detailed Message** – The details regarding the operation, such as “*Transferring CA certificate*”
- **Size** – The total number of bytes in the file (not displayed on the web UI)
- **Bytes Transferred** – The number of bytes already transferred or processed (not displayed on the web UI)
- **Percent Complete** – The percentage complete for the operation

To view the status of the import process in the CLI, ensure the CLI is in operational mode and then follow the example below:

```
> show pki firmware-certs import-status
pki ca-certs firmware-certs state complete
pki ca-certs firmware-certs detailed-message "Successfully imported firmware certificate"
pki ca-certs firmware-certs size 1586
pki ca-certs firmware-certs bytes-transferred 1586
pki ca-certs firmware-certs percent-complete 100
```

### 3.9.6 SCEP and CA Configuration

The process of interacting with a SCEP server involves getting the currently published certificate(s) from the CA and then making a request for a client certificate with information and key material.

Before any attempt to interact with the SCEP server, the SCEP server itself, the CA associated with the SCEP server must be identified and the certificate information must be defined.

#### Configuring

The certificate server is defined under certificate-server. In the operation shown below, we define the SCEP server.

```
> set pki certificate-servers certificate-server predefined_cert_server server-type scep scep-
server-setting uri 10.15.60.39/certserv/mscep/mscep.dll poll-interval 5 retry-count 120
digest-algo sha256 encrypt-algo aes128_cbc
```

This defines the server that is running the SCEP protocol on an accessible network. The unit will append an 'http://' to the URL so it must not be entered as part of the uri parameter in the configuration. Note also, the above is just an example. The IP address, specific port (if different from the default) and path to .dll or .cgi or other SCEP server mechanism must be obtained from the System Administration or Security personnel.

The configuration of the Certificate Authority that will be accessed at the above server is setup in a second command under ca-servers.

```
> set pki ca-servers ca-server predefined_ca_server ca-fingerprint
8777AF0253204589452ECC3CDB9DEC77
```

The fingerprint of the CA server is another data item obtained from the System Administrator or Security personnel. The CA server name is the name that will be referenced in the SCEP operations described below. In general, it is simply for reference and does not have to be a specific name. In fact, it can be the same name as the ca-server if this helps to remember it. Also, client certificate information that goes in



the “Subject” portion of an X.509 certificate must be configured. Some fields may be fixed/required by the specific SCEP server.

The CA fingerprint on the MCR should contain only alpha-numeric characters without spaces or separators (i.e. commas, colons etc.).

```
> set pki cert-info certificate-info predefined_cert_info
```

**Possible completions:**

```
common-name-x509 -
country-x509 -
locale-x509 -
org-unit-x509 -
organization-x509 -
pkcs9-email-x509 -
state-x509 -
```

The parameters that must be entered for the client certificate information must again be obtained from the System Administration or Security personnel. The common name will always be required. Other parameters may be required.

Here is an example:

```
> set pki cert-info certificate-info predefined_cert_info organization-x509 "GE MDS LLC" org-
unit-x509 Engineering common-name-x509 00102200000102030411223344556670
```

## Obtaining a New Certificate

To obtain a new client certificate from a SCEP server, the first step is to request the CA certificate from the SCEP server.

```
> request pki ca-certs import cert-identity scep_ca_cert scep {
ca-issuer-identity predefined_ca_server cert-server-identity predefined_cert_server }
```

The next step is to request the new client certificate from the SCEP server.

```
> request pki client-certs import cert-identity scep_client_cert scep {
cert-server-identity predefined_cert_server ca-issuer-identity predefined_ca_server cert-info-
identity predefined_cert_info ca-cert-identity scep_ca_cert private-key-identity
imported_key_2048 ca-challenge 36DE2A1E53BECF9AE5BB3E0B12D4C85E }
```

## Renewing an Existing Certificate

At some point, the dates on the certificate will need to be renewed due to time or security policy. A client certificate can be renewed using the existing certificate with the same key as originally used when it was generated. An alternative is to provide a new key and identify for the certificate that is to be renewed and rekeyed.

The following example shows how to new an existing client certificate from the SCEP server:

```
> request pki client-certs import cert-identity renewed_scep_client_cert scep { cert-server-
identity predefined_cert_server ca-issuer-identity predefined_ca_server cert-info-identity
predefined_cert_info ca-cert-identity scep_ca_cert private-key-identity imported_key_2048
existing-cert-identity scep_client_cert existing-private-key-identity imported_key_2048 }
```





## 4.0 TECHNICAL REFERENCE

### 4.1 Troubleshooting

All units must meet the basic requirements listed below for proper operation. Check these items first when troubleshooting a system problem:

- Adequate and stable primary power
- Secure connections (antennas, data and power)
- A clear transmission path between associated units
- An efficient, properly installed antenna system
- Proper configuration of unit settings
- Correct interface between the unit and other equipment

#### 4.1.1 LED Status Indicators

The LEDs on the unit are visual indications of the status of the device. These indicators can provide useful information when troubleshooting. Refer to Table 4-3, Table 4-4, Table 4-5, and Table 4-6.

Depending on the interfaces ordered, the NIC1 and NIC2 slot can be populated with a Cellular modem, a WiFi interface, an LnRadio interface or an NxRadio interface. Described in Table 4-1 below, are the possible NIC1 and NIC2 LED combinations based on the product configuration ordered.



**Figure 4-1. LED Status Indicators**

**Table 4-1. NIC LED Descriptions**

| Product Configuration | NIC1     | NIC2                      |
|-----------------------|----------|---------------------------|
| MCR-4G + WiFi         | Cellular | WiFi                      |
| MCR-4G Only           | Cellular | Off                       |
| MCR-3G + WiFi         | Cellular | WiFi                      |
| MCR-3G Only           | Cellular | Off                       |
| MCR-WiFi only         | Off      | WiFi                      |
| MCR-900 + 4G          | Cellular | 900 ISM (NxRadio)         |
| MCR-900 + WiFi        | WiFi     | 900 ISM (NxRadio)         |
| MCR-900 + 3G          | Cellular | 900 ISM (NxRadio)         |
| MCR-900 Only          | Off      | 900 ISM (NxRadio)         |
| MCR-LN + 3G           | Cellular | Lic. Narrowband (LnRadio) |
| MCR-LN + WiFi         | WiFi     | Lic. Narrowband (LnRadio) |
| MCR-LN + 3G           | Cellular | Lic. Narrowband (LnRadio) |
| MCR-LN Only           | Off      | Lic. Narrowband (LnRadio) |



**Table 4-2. ECR NIC LED Descriptions**

| <b>Product Configuration</b> | <b>NIC1</b> | <b>NIC2</b>               |
|------------------------------|-------------|---------------------------|
| ECR-4G + WiFi                | Cellular    | WiFi                      |
| ECR-4G Only                  | Cellular    | Off                       |
| ECR-3G + WiFi                | Cellular    | WiFi                      |
| ECR-3G Only                  | Cellular    | Off                       |
| ECR-WiFi only                | Off         | WiFi                      |
| ECR-900 + WiFi               | WiFi        | 900 ISM (NxRadio)         |
| ECR-900 Only                 | Off         | 900 ISM (NxRadio)         |
| ECR-LN + WiFi                | WiFi        | Lic. Narrowband (LnRadio) |
| ECR-LN Only                  | Off         | Lic. Narrowband (LnRadio) |

**Table 4-3. Cell Interface LED Descriptions**

| <b>LED - NIC1</b> | <b>LED State</b> | <b>Description</b>     |
|-------------------|------------------|------------------------|
| Cell Interface    | Off              | No cellular connection |
|                   | Solid green      | Cell connection        |

**Table 4-4. WiFi Interface LED Descriptions**

| <b>LED - NIC1</b> | <b>LED State</b> | <b>Description</b>                                 |
|-------------------|------------------|----------------------------------------------------|
| WiFi Interface    | Off              | Interface disabled                                 |
| Access Point Mode | Solid Green      | Operating as AP and at least one client connection |
|                   | Solid Red        | Operating as an AP and no client connection        |
| Station Mode      | Off              | No connection                                      |
|                   | Solid Green      | Wi-Fi connection established.                      |

**Table 4-5. NxRadio Interface LED Descriptions**

| <b>LED - NIC2</b> | <b>State</b> | <b>Description</b>                                 |
|-------------------|--------------|----------------------------------------------------|
| NxRadio Interface | Off          | Interface disabled                                 |
| Access Point Mode | Blink Red    | NIC Initialization                                 |
|                   | Solid Red    | No Remotes connected                               |
|                   | Solid Green  | Linked with at least 1 Remote                      |
| Remote Mode       | Blink Red    | NIC Initialization / Not linked to an Access Point |
|                   | Solid Green  | Linked with Access Point                           |



**Table 4-6. LnRadio Interface LED Descriptions**

| LED - NIC2        | State       | Description                                           |
|-------------------|-------------|-------------------------------------------------------|
| LnRadio Interface | Off         | Interface disabled                                    |
| Access Point Mode | Blink Red   | LN NIC Initialization                                 |
|                   | Solid Red   | No Remotes connected                                  |
|                   | Solid Green | Linked with at least 1 Remote                         |
| Remote Mode       | Blink Red   | LN NIC Initialization / Not linked to an Access Point |
|                   | Solid Green | Linked with Access Point                              |

**NOTE** In addition to the LEDs listed on the previous page, the Ethernet connector has two embedded LEDs. A yellow indicates a link at 100 Mbps operation. A flashing green indicates Ethernet data traffic.

## 4.2 Technical Specifications

### GENERAL

Input Power

11 to 55 VDC, NOMINAL

10 to 60 VDC, 15 Watts maximum (depending on configuration)

Below are power consumption figures for common configurations:

Typical High Throughput Wi-Fi power consumption <= 4.1 Watts

Minimum Wi-Fi power consumption <= 3.4 Watts

**Table 4-7. Orbit MCR-4G Power Consumption:**

Power Consumption (nominal, 25C, **Cellular Only**)

| Mode                         | Power | 13.8V |
|------------------------------|-------|-------|
| Connected (Idle)             | 4.0W  | 292mA |
| Connected (Typical Download) | 4.3W  | 310mA |

**Table 4-8. Orbit MCR-3G Power Consumption:**

Power Consumption (nominal, 25C, **Cellular Only**)

| Mode                         | Power | 13.8V |
|------------------------------|-------|-------|
| Connected (Idle)             | 2.5W  | 182mA |
| Connected (Typical Download) | 3.2W  | 235mA |



**Table 4-9.Orbit MCR-900 Power Consumption:**

Power Consumption (nominal, Output Power = 1W, 25C)

| Mode                          | Power | 13.8V |
|-------------------------------|-------|-------|
| AP (Idle)                     | 4.0W  | 293mA |
| AP (50% Duty)                 | 5.3W  | 382mA |
| Remote (Associated, Idle)     | 3.2W  | 235mA |
| Remote (Associated, 50% Duty) | 5.0W  | 365mA |

**Table 4-10.Orbit MCR-LN Power Consumption:**

Power Consumption (nominal, Output Power = 1W, 25C)

| Mode                          | Power | 13.8V |
|-------------------------------|-------|-------|
| AP (Idle)                     | 12.6W | 910mA |
| AP (50% Duty)                 | 13.1W | 950mA |
| Remote (Associated, Idle)     | 4.8W  | 350mA |
| Remote (Associated, 50% Duty) | 10.8W | 780mA |

|                  |                                                                                                         |
|------------------|---------------------------------------------------------------------------------------------------------|
| Ethernet Port(s) | RJ-45 10/100 Mbps Auto-MDIX                                                                             |
| Serial Port(s)   | RJ-45, supporting RS-232/RS-485                                                                         |
| LAN Protocols    | 802.3 (Ethernet) 802.1D (Spanning Tree) TCP/IP, DHCP, ICMP, IGMP, FTP, TFTP, SFTP, UDP, SNMP, VPN, VLAN |
| Networking       | DHCP, Port Forwarding, NAT, VLAN, SNMP                                                                  |
| Configuration    | Serial console, SSH, HTTP/HTTPS, Configuration files                                                    |
| Security         | Encryption, Password access, Radius, Firewall, SCEP, VPN                                                |

**Physical**

---

|         |                                                                    |
|---------|--------------------------------------------------------------------|
| Size    | 8.0" long (20.32 cm), 4.8" wide (12.192 cm), 1.75" High (4.445 cm) |
| Housing | Die-cast Aluminum                                                  |
| Weight  | 2 lbs. (without mounting hardware)                                 |

**Environmental**

---

|                             |                |
|-----------------------------|----------------|
| Operating Temperature Range | -40°C to +70°C |
|-----------------------------|----------------|






---

**NOTE** For Orbit ECR equipped with LN400 or LN900, the maximum continuous duty cycle while operating at 70C is 10%

---

**NOTE** Operating temperature range may be reduced based on model configuration. See product label for detail.

---



**Caution:** This device may exceed safe handling temperatures when operated in an ambient temperature above 55°.

### Agency/Regulatory Approvals

---

#### FCC

WiFi – M4Y-ZCN722MV1  
 4G cell (E4V) – PKRNVWE362  
 3G Cell – RI7HE910  
 4G cell (4G1..4G5) – N7NMC7355  
 4G cell (4GP) – N7NMC7354B  
 NX915 – E5MDS-NX915  
 LN400 – E5MDS-LN400  
 LN900 – E5MDS-LN900

#### IC - Industry

WiFi – 3195A-ZCN722MV1  
 4G cell (E4V) - 3229B-E362  
 3G Cell – 5131A-HE910  
 NX915 – 101D-NX915  
 LN400 – 101D-LN400  
 LN900 – 101D-LN900

### 2.4 GHz WiFi Specifications

---

|                        |                                                             |
|------------------------|-------------------------------------------------------------|
| Protocol               | IEEE 802.11b/g/n OFDM 6 to 54Mbps, CCK 1 to 11Mbps          |
| Frequency Range        | 2400 to 2500 MHz                                            |
| Maximum Transmit Power | 18 dBm (Default is 15 dBm)                                  |
| Permissible Antennas   | GE MDS 97-4278A36<br>GE MDS 97-4278A34<br>GE MDS 97-4278A35 |
| FCC                    | Part 15C                                                    |
| FCC ID                 | M4Y-ZCN722MV1                                               |
| WiFi Antenna Connector | Female Reverse SMA                                          |

### 4G LTE/CDMA (Verizon Only)

---

LTE 1900(B2), AWS (B4), 850(B5), 700 (B13), 700(B17), 1900(B25)  
 CDMA 1xRTT/EV-DO Rev A - 800(BC0), 1900(BC1), 800(BC10)



### 4G LTE, HSPA+, GSM/GPRS (EMEA/APAC)

---

LTE 2100(B1), 1800(B3), 2600(B7), 900(B8), 800(B20) MHz  
GSM/GPRS/EDGE 850/900/1800/1900 MHz  
UMTS/HSPA/HSPA+ 2100(B1), 1900(B2), 850(B5), 900(B8) MHz

### 4G LTE, HSPA+, GSM/GPRS (North America)

---

LTE 1900(B2), AWS (B4), 850(B5), 700 (B13), 700(B17), 1900(B25)  
GSM/GPRS/EDGE 850/900/1800/1900 MHz  
UMTS/HSPA/HSPA+ 2100(B1), 1900(B2), AWS (B4), 850(B5), 900(B8) MHz

### 3G Cell

---

GSM/GPRS/EDGE 850/900/1800/1900 MHz  
UMTS/HSPA/HSPA+ 800/850, 900, AWS1700, 1900, 2100 MHz

### 900 MHz ISM - Unlicensed

---

|                                                   |                                                                                                                   |
|---------------------------------------------------|-------------------------------------------------------------------------------------------------------------------|
| Frequency Range                                   | 902 to 928 MHz                                                                                                    |
| Power Output                                      | 20 dBm to 30 dBm in 1.0 dBm steps (DEFAULT = 30 dBm)                                                              |
| Output Impedance                                  | 50 Ohms                                                                                                           |
| Permissible Antennas                              | GE MDS 93-/97-3194A14, 10dBd (12.15dBi) YAGI Antenna<br>GE MDS 93-/97-3194A23, 7dBd (9.15dBi) 5/8 wavelength OMNI |
| Antenna Connector                                 | TNC female                                                                                                        |
| Number of Frequency Channels                      | Selectable 50 to 81 for FHSS, 1 to 20 for DTS                                                                     |
| Channel Separation                                | 307.5 kHz minimum                                                                                                 |
| Modulation Type                                   | 2-Level GFSK / 4-Level GFSK                                                                                       |
| Data Rates                                        | 125, 250, 500, 1000, 1000W, 1250 kbps                                                                             |
| Peak Frequency Deviation                          | 1250 kbps / 4-level GFSK: 550 kHz                                                                                 |
| Beacon Interval                                   | 10 to 300 ms (DEFAULT is 150)                                                                                     |
| Dwell Time                                        | 10 to 400 ms (DEFAULT is 50)                                                                                      |
| FCC Part 15.247 under modular rules per DA00-1407 |                                                                                                                   |
| FCC ID                                            | E5MDS-NX915                                                                                                       |
| ICID                                              | 101D-NX915                                                                                                        |
| Modulation rate / bandwidth combinations          | See Table 3-9                                                                                                     |



## 400 MHz Licensed Narrowband

---

|                                                        |                                                                                                                                                                                                                                                                                                                                                                                                                                                                                         |
|--------------------------------------------------------|-----------------------------------------------------------------------------------------------------------------------------------------------------------------------------------------------------------------------------------------------------------------------------------------------------------------------------------------------------------------------------------------------------------------------------------------------------------------------------------------|
| Frequency Range(s)                                     | 406 to 470 MHz<br>330 to 406 MHz                                                                                                                                                                                                                                                                                                                                                                                                                                                        |
| Power Output                                           | 30 dBm to 40 dBm in 1.0 dBm steps (DEFAULT = 40 dBm)                                                                                                                                                                                                                                                                                                                                                                                                                                    |
| Output Impedance                                       | 50 Ohms                                                                                                                                                                                                                                                                                                                                                                                                                                                                                 |
| Permissible Antennas                                   | Various options based on user license, including ..<br>GE MDS 93-/97-3194A18, 406-430MHz, 7dBi OMNI w/16" Jumper N-F Conn & Mnt<br>GE MDS 93-/97-3194A19, 430-450MHz, 7dBi OMNI w/16" Jumper N-F Conn & Mnt<br>GE MDS 93-/97-3194A26, 450-470MHz, 11 dBi OMNI w/N-F Conn & Mnt<br>GE MDS 93-/97-3194A02, 406-430MHz, 12 dBi YAGI w/N-F Conn & Mnt<br>GE MDS 93-/97-3194A04, 406-430MHz, 12 dBi YAGI w/N-F Conn & Mnt<br>GE MDS 93-/97-3194A06, 450-470MHz, 12 dBi YAGI w/N-F Conn & Mnt |
| Antenna Connector                                      | TNC female                                                                                                                                                                                                                                                                                                                                                                                                                                                                              |
| Modulation Type                                        | QAM (QPSK, 16QAM, 64QAM)                                                                                                                                                                                                                                                                                                                                                                                                                                                                |
| Data Rates                                             | 20, 40, 60 kbps (in 12.5Khz)<br>40, 80, 120 kbps (in 25.0Khz)                                                                                                                                                                                                                                                                                                                                                                                                                           |
| FCC Part 90 under limited modular rules per KDB 996369 |                                                                                                                                                                                                                                                                                                                                                                                                                                                                                         |
| FCC ID                                                 | E5MDS-LN400                                                                                                                                                                                                                                                                                                                                                                                                                                                                             |
| IC                                                     | 101D-LN400                                                                                                                                                                                                                                                                                                                                                                                                                                                                              |



## 900 MHz Licensed Narrowband

---

|                        |                                                                                                                                                                                                                                                                        |
|------------------------|------------------------------------------------------------------------------------------------------------------------------------------------------------------------------------------------------------------------------------------------------------------------|
| Frequency Range        | 896 to 960 MHz                                                                                                                                                                                                                                                         |
| Power Output           | 30 dBm to 40 dBm in 1.0 dBm steps (DEFAULT = 40 dBm)                                                                                                                                                                                                                   |
| Output Impedance       | 50 Ohms                                                                                                                                                                                                                                                                |
| Permissible Antennas   | Various options based on user license, including ..<br>GE MDS 93-/97-3194A17, 902-928MHz, 9dBi OMNI w/16" Jumper N-F Conn<br>GE MDS 93-/97-3194A14, 902-960MHz, 12 dBi YAGI 6 Elementw/N-F Conn<br>GE MDS 93-/97-3194A13, 902-960MHz, 8.5 dBi YAGI 3 Elementw/N-F Conn |
| Antenna Connector      | TNC female                                                                                                                                                                                                                                                             |
| Modulation Type        | QAM (QPSK, 16QAM, 64QAM)                                                                                                                                                                                                                                               |
| Data Rates             | 20, 40, 60 kbps (in 12.5Khz)<br>40, 80, 120 kbps (in 25.0Khz)                                                                                                                                                                                                          |
| FCC Part 90 & Part 101 |                                                                                                                                                                                                                                                                        |
| FCC ID                 | E5MDS-LN900                                                                                                                                                                                                                                                            |
| IC                     | 101D-LN900                                                                                                                                                                                                                                                             |

---

**NOTE** All specifications are subject to change without notice or obligation.

---





## 5.0 Glossary of Terms and Abbreviations

If you are new to wireless communications systems, some of the terms used in this guide may be unfamiliar. The following glossary explains many of these terms and will prove helpful in understanding the operation of the unit. While some of these terms may not appear in the text, they are included here to promote a more complete understanding of wireless technology.

**Antenna System Gain:** A figure, normally expressed in dB, representing the power increase resulting from the use of a gain-type antenna. System losses (from the feedline and coaxial connectors, for example) are subtracted from this figure to calculate the total antenna system gain.

**Bit:** The smallest unit of digital data, often represented by a one or a zero. Eight bits (plus start, stop, and parity bits) usually comprise a byte.

**Bits-per-second:** See *BPS*.

**BPS (Bits-per-second):** A measure of the information transfer rate of digital data across a communication channel.

**Bridging:** (see Ethernet Bridging)

**Byte:** A string of digital data usually made up of eight data bits and start, stop and parity bits.

**CLI:** Command Line Interface. A method of user control where commands are entered as character strings to set configuration and operating parameters.

**CTS:** Clear to Send

**Decibel (dB):** A measure computed from the ratio between two signal levels. Frequently used to express the gain (or loss) of a system.

**Data Circuit-terminating Equipment:** See *DCE*.

**Data Communications Equipment:** See *DCE*.

**Data Terminal Equipment:** See *DTE*.

**dBi:** Decibels referenced to an “ideal” isotropic radiator in free space, frequently used to express antenna gain.

**dBm:** Decibels referenced to one milliwatt. An absolute unit used to measure signal power, as in transmitter power output, or received signal strength.

**DCE (Data Circuit-terminating Equipment)** (or Data Communications Equipment): In data communications terminology, this is the “modem” side of a computer-to-modem connection. The unit described in this manual is hardwired as a DCE device.

**DTE (Data Terminal Equipment):** A device that provides data in the form of digital signals at its output. DTE connects to the DCE device.

**ETH:** Ethernet

**Ethernet Bridging:** Involves combining an Ethernet interface with one or more other interfaces under a single interface.

**Fade Margin:** The greatest tolerable reduction in average received signal strength that will be anticipated under most conditions. It provides an allowance for reduced signal strength due to multipath, slight antenna movement or changing atmospheric losses. A fade margin of 20 to 30 dB is usually sufficient in most systems.

**Frame:** A segment of data that adheres to a specific data protocol and contains definite start and end points. It provides a method of synchronizing transmissions.



**Hardware Flow Control:** A feature used to prevent data buffer overruns when the unit is handling high-speed data from an RTU or PLC. When the buffer approaches overflow, the unit drops the clear-to-send (CTS) line, which instructs the RTU or PLC to delay further transmission until CTS again returns to the high state.

**Host Computer:** The computer installed at the master unit, which controls the collection of data from one or more remote sites.

**IP:** Internet Protocol

**LAN:** Local Area Network

**LED:** Light Emitting Diode

**LNxxx:** Orbit NIC module supporting licensed narrowband operation.

**LN400:** Orbit NIC module supporting licensed narrowband operation at 400 MHz.

**LN900:** Orbit NIC module supporting licensed narrowband operation at 900 MHz.

**mA:** Milliamperes

**MAC:** Media Access Control

**Narrowband:** These are channel sizes of 25KHz and down. The LN NIC module supports Licensed Narrowband.

**NIC:** Network Interface Card. This is another name for the modules that are selectively included in the product based on Orbit MCR order entry.

**NX915:** Orbit NIC module supporting unlicensed operation at 900 MHz.

**Poll:** A request for data issued from the host computer (or master PLC) to a Remote unit.

**PLC (Programmable Logic Controller):** A dedicated microprocessor configured for a specific application with discrete inputs and outputs. It can serve as a host or as an RTU.

**PPM:** Parts per Million

**Programmable Logic Controller:** See *PLC*.

**Remote Terminal Unit:** See *RTU*.

**RTS:** Request-to-send

**RTU:** Remote Terminal Unit. A data collection device installed at a Remote unit site.

**RX:** Abbreviation for "Receive."

**SAF (Store and Forward):** An available feature of the unit whereby data is stored by a designated Remote, and then retransmitted to a station beyond the communication range of the AP.

**SCADA (Supervisory Control And Data Acquisition):** An overall term for the functions commonly provided through a multiple address radio system.

**SCEP (Simple Certificate Enrollment Protocol):** A scalable protocol for networks based on digital certificates, which can be requested by users without the need for assistance or manual intervention from a system administrator.

**Signal-to-Noise Ratio:** See *SNR*.

**SNR (Signal-to-Noise ratio):** A measure of how well the signal is being received at a radio relative to noise on the channel.

**SSH:** Secure Shell protocol for a network that allows users to open a window on a local PC and connect to a remote PC as if they were present at the remote.



**SSID (Service Set Identifier):** A name that identifies a particular 802.11 wireless LAN.

**Supervisory Control And Data Acquisition:** See *SCADA*.

**Telnet:** A terminal emulation protocol that enables an Internet user to communicate with a Remote device for management activities as if it were locally connected to a PC.

**TX:** Abbreviation for “Transmit.”

**WAN:** Wide Area Network







## 6.0 APPENDIX A – Command Line Interface (CLI) Features

### 6.1 Operational Mode

Operational Mode is the initial mode that the CLI is in right after logging in. Users can view operational and configuration data but cannot change configuration data. The prompt will show a “>” character when it is in operational mode.

### 6.2 Configuration Mode

Configuration mode is entered when the user types “configure” after logging in. Configuration Mode can be exited by typing “exit”, which brings the user back to Operational Mode. Configuration data can only be altered while the user is in Configuration Mode. The prompt will have a “%” character when it is in configuration mode.

### 6.3 Changing Configuration Data

Configuration data can only be changed while the CLI is in Configuration Mode. Changing configuration requires the two-step process described earlier, where changes can be made first and then must be committed to complete the process.

Once all the changes have been made, they can be committed using the “commit” command. If there is an error during the commit due to missing data, conflicting settings, or other issue, then none of the changes will be committed and the CLI will provide feedback regarding the error. The changes that were pending will still be pending at that point. This gives the user the opportunity to discard the changes or to modify them and then try to commit them again.

### 6.4 Inputting Values

The format for each node in the data model is encoded in the data model itself. The CLI enforces the user input to be compliant to that format. There are several different formats of input, including numerics, strings, and limitations on the range and length of input. The CLI will provide assistance to the user when inputting values when the tab-completion feature is used (see Tab-completion section below).

The example below shows the “possible completions” when the TAB key is pressed after the word “location”. In this case, the node “location” can take a value that is a string with 0-255 characters.

```
% set system location
Possible completions:
  <string, min: 0 chars, max: 255 chars>
% set system location "Rochester, NY"
[ok][2012-06-19 00:56:49]

[edit]
% commit
Commit complete.
[ok][2012-06-19 00:57:01]
```

### 6.5 Input of a List of Values

A node can take a list of values if it has been defined that way in the data model. The CLI will indicate a node can take a list by displaying a bracket [, as shown below at the end of the possible completions information. Items in the list are separated by a space character.

This example shows that there are three ways to input values to a list node:



**% set system dns search**

**Possible completions:**

**<IP address> <string, min: 1 chars, max: 253 chars>**

1. Without brackets, the value will be appended to the existing list gemds

**% set system dns search gemds**

2. With brackets, for a list that contains one value: “[ gemds ]”

**% set system dns search [gemds]**

3. With brackets, for a list that contains more than one value: “[ ge gemds ]”

**% set system dns search [ge gemds]**

## 6.6 Tab-Completion

Tab-completion is a powerful feature that presents CLI users with assistance while typing. Depending on the text that was already typed, tab-completion will display different possible completions.

When the tab key is pressed and no text has been typed, the CLI shows all of the possible commands that can be typed, as shown below. In this example, the CLI is in configuration mode and the following commands are relevant to configuration mode only.

**%**

**Possible completions:**

**annotate - Add a comment to a statement**

**commit - Commit current set of changes**

**compare - Show configuration differences**

**copy - Copy a dynamic element**

**delete - Delete a data element**

**edit - Edit a sub-element**

**exit - Exit from this level**

**help - Provide help information**

**insert - Insert a parameter**

**move - Move a parameter**

**quit - Exit from this level**

**rename - Rename an identifier**

**request - Make system-level requests**

**resolved - Conflicts have been resolved**

**revert - Copy configuration from running**

**rollback - Roll back database to last committed version**

**run - Run an operational-mode command**

**set - Set a parameter**

**show - Show a parameter**

**status - Display users currently editing the configuration**

**tag - Manipulate statement tags**

**top - Exit to top level and optionally run command**

**up - Exit one level of configuration**

**validate - Validate current configuration**

When the tab key is pressed after a typed command, then the CLI will show the user all the possible options that are pertinent to that command. In the example below the tab key was pressed after the word “set”. The list of possible completions is shown to user.

**% set**

**Possible completions:**

**SNMP-Community-MIB**

**SNMP-Target-MIB**



- SNMP-User-Based-SM-MIB
- SNMP-View-Based-ACM-MIB
- file-servers -
- interfaces - Interface parameters.
- logging-
- pki - Public Key and Certificate Options
- routing -
- services - Services which are configurable on this system
- system - System group configuration

When the tab key is pressed after the name of a data node that the user is trying to configure, then the CLI will show the user the format of the data that is acceptable for that data node. In the example below, the tab key was pressed after the word “search”. In this case, the node “search” can take a list of values that are IP addresses or strings, each with 0-255 characters.

```
% set system dns search
Possible completions:
<IP address> <string, min: 1 chars, max: 253 chars>

% set system dns search mds
```

## 6.7 CLI Environment

There are a number of session variables in the CLI. They are only used during the session and are not persistent. Their values are inspected using “show cli” and set using “set” in operational mode.

```
> show cli
autowizard true;
complete-on-space true;
display-level 99999999;
history 100;
idle-timeout 1800;
ignore-leading-space false;
output {
  file terminal;
}
paginate true;
prompt1 \u@\h\M \t> ;
prompt2 \u@\h\M \t% ;
screen {
  length 24;
  width 80;
}
show {
  defaults false;
}
terminal linux;
```

The different values control different parts of the CLI behavior.

### autowizard (true | false)

- When enabled, the CLI will prompt the user for required settings when a new identifier is created and for mandatory action parameters.
- For example, the “filename” parameter will be requested from the user since it is mandatory and yet it was not supplied in the initial request:



**% request system firmware reprogram-inactive-image preconfigured-file-server**  
**{configuration\_name fs1}**

**Value for 'filename' (<string>): fw.pkg**

- To avoid prompting, it is recommended to disable the **autowizard** before pasting in a list of commands. A good practice is to start all such scripts with a line that disables the

**autowizard:**

**set autowizard false**

...

**set autowizard true**

**complete-on-space (true | false)**

- Controls if command completion should be attempted when <space> is entered. Entering <tab> always results in command completion.

**ignore-leading-space (true | false)**

- Controls if leading spaces should be ignored or not. This is useful to turn off when pasting commands into the CLI.

**history (<integer>)**

- Size of CLI command history.

**idle-timeout (<seconds>)**

- Maximum idle time before being logged out. Use 0 (zero) for infinity.

**paginate (true | false)**

- Some commands paginate their output, for example. This can be disabled or enabled. It is enabled by default.

**screen width (<integer>)**

- Current width of terminal. This is used when paginating output to get proper line count.

**screen length (<integer>)**

- Current length of terminal. This is used when paginating output to get proper line count.

**terminal (string)**

- Terminal type. This setting is used for controlling how line editing is performed. Supported terminals are: dumb, vt100, xterm, linux, and ansi. Other terminal types may also work, but have no explicit support.

## 6.8 Command Output Processing

It is possible to process the output from a command using an output redirect. This is done using the | character. The commands can be chained to achieve more complex processing.

**> show configuration |**

**Possible completions:**

**annotation** - Show only statements whose annotation matches a pattern

**context match** - context match

**count** - Count the number of lines in the output

**csv** - Emit table output in CSV format

**de-select** - select columns to not include

**details** - Display details

**display** - Display options

**except** - Show only text that does not matches a pattern

**extended** - Show referring elements

**find** - Search for the first occurrence of a pattern

**hide** - Hide display options



- linnum** - Enumerate lines in the output
- match** - Show only text that matches a pattern
- match-all** - All selected filters must match
- match-any** - At least one filter must match
- more** - Paginate output
- nomore** - Suppress pagination
- select** - Select additional columns
- tab** - Enforce table output
- tags** - Show only statements whose tags matches a pattern
- until** - Display until the first occurrence of a pattern

```
admin@(none) 17:20:27> show configuration |
```

## 6.9 Count the Number of Lines in the Output

This redirect target counts the number of lines in the output. For example:

```
> show configuration | count
[ok][2007-08-31 13:49:44]
Count: 99 lines
> show configuration interfaces | count
[ok][2007-08-31 13:50:12]
Count: 90 lines
```

## 6.10 Search for a String in the Output

The match target is used to only include lines matching a regular expression. For example:

```
> show configuration logging | match date
event-rules date_time_from_ntp {
event-rules date_time_from_user {
event-rules date_time_not_set {
```

In the example above only lines containing “date” are shown. Similarly lines not containing a regular expression can be included.

```
> show interface-state | except counters
interfaces supported-interfaces bridge true
interfaces interface eth0
if-index 2
status mac-address 1e:ed:19:27:1a:b3
status mtu 1500
status link up
status ipv4 address [ 192.168.1.10/24 ]
status ipv6 address [ fe80::1ced:19ff:fe27:1ab3/64 ]
```

It is also possible to display the output starting at the first match of a regular expression, using the find target. For example:

```
> show interface-state | find tx
status counters tx_aborted_errors 0
status counters tx_bytes 238574
status counters tx_carrier_errors 0
status counters tx_compressed 0
status counters tx_dropped 0
status counters tx_errors 0
status counters tx_fifo_errors 0
status counters tx_heartbeat_errors 0
```



```
status counters tx_packets 1731
status counters tx_window_errors 0
```

Output can also be ended when a line matches a regular expression. This is done with the until target. For example:

```
> show interface-state | find tx | until compressed
status counters tx_aborted_errors 0
status counters tx_bytes 250246
status counters tx_carrier_errors 0
status counters tx_compressed 0
```

## 6.11 Regular Expressions

The regular expressions is a subset of the regular expressions found in egrep and in the AWK programming language. Some common operators are:

|           |                                                                                                                                        |
|-----------|----------------------------------------------------------------------------------------------------------------------------------------|
| .         | Matches any character.                                                                                                                 |
| ^         | Matches the beginning of a string.                                                                                                     |
| \$        | Matches the end of a string.                                                                                                           |
| [abc...]  | Character class, which matches any of the characters abc...<br>Character ranges are specified by a pair of characters separated by a - |
| [^abc...] | negated character class, which matches any character except abc...                                                                     |
| r1   r2   | Alternation. It matches either r1 or r2.                                                                                               |
| r1r2      | Concatenation. It matches r1 and then r2.                                                                                              |
| r+        | Matches one or more rs.                                                                                                                |
| r*        | Matches zero or more rs.                                                                                                               |
| r?        | Matches zero or one rs.                                                                                                                |
| (r)       | Grouping. It matches r.                                                                                                                |

For example, to only display uid and gid you can do the following:

```
> show configuration | match "(uid) | (gid)"
uid 1000;
gid 100;
uid 1000;
gid 100;
uid 1000;
gid 100;
uid 1000;
gid 100;
```

## 6.12 Display Line Numbers

The linum target causes a line number to be displayed at the beginning of each line in the display.

```
> show configuration | match "(uid) | (gid)" | linum
1: uid 1019;
2: gid 1013;
3: uid 1019;
4: gid 1013;
5: uid 1019;
6: gid 1013;
7: uid 1019;
```



8: gid 1013;

## 6.13 Showing Information

Reserved for a future release.

## 6.14 Control Sequences

The default key strokes for editing the command line and moving around the command history are as follows.

|                                                              |                                         |
|--------------------------------------------------------------|-----------------------------------------|
| Move the cursor back one character                           | Ctrl-b or Left Arrow                    |
| Move the cursor back one word                                | Esc-b or Alt-b                          |
| Move the cursor forward one character                        | Ctrl-f or Right Arrow                   |
| Move the cursor forward one word                             | Esc-f or Alt-f                          |
| Move the cursor to the beginning of the command line         | Ctrl-a or Home                          |
| Move the cursor to the end of the command line               | Ctrl-e or End                           |
| Delete the character before the cursor                       | Ctrl-h, Delete, or Backspace            |
| Delete the character following the cursor                    | Ctrl-d                                  |
| Delete all characters from the cursor to the end of the line | Ctrl-k                                  |
| Delete the whole line                                        | Ctrl-u or Ctrl-x                        |
| Delete the word before the cursor                            | Ctrl-w, Esc-Backspace, or Alt-Backspace |
| Delete the word after the cursor                             | Esc-d or Alt-d                          |
| Insert the most recently deleted text at the cursor          | Ctrl-y                                  |
| Scroll backward through the command history                  | Ctrl-p or Up Arrow                      |
| Scroll forward through the command history                   | Ctrl-n or Down Arrow                    |
| Search the command history in reverse order                  | Ctrl-r                                  |
| Show a list of previous commands                             | run the "show cli history" command      |
| Capitalize the word at the cursor                            | Esc-c                                   |
| Change the word at the cursor to lowercase                   | Esc-l                                   |
| Change the word at the cursor to uppercase                   | Esc-u                                   |
| Abort a command/Clear line                                   | Ctrl-c                                  |
| Quote insert character                                       | Ctrl-v/ESC-q                            |
| Redraw the screen                                            | Ctrl-l                                  |
| Transpose characters                                         | Ctrl-t                                  |
| Enter multi-line mode                                        | ESC-m                                   |

## 6.15 Commands

The commands available to the user differs, depending on whether the CLI is in operational mode or configuration mode. The following commands are describe in the next sections:

| Operational Mode Commands | Configuration Mode Commands |
|---------------------------|-----------------------------|
| commit                    | annotate                    |
| configure                 | commit                      |
| exit                      | compare                     |
| help                      | copy                        |
| ping                      | delete                      |





|            |          |
|------------|----------|
| quit       | edit     |
| script     | exit     |
| set        | help     |
| request    | insert   |
| set-path   | move     |
| show       | quit     |
| ssh        | rename   |
| telnet     | request  |
| top        | resolved |
| traceroute | revert   |
| up         | rollback |
|            | run      |
|            | set      |
|            | show     |
|            | status   |
|            | tag      |
|            | top      |
|            | up       |
|            | validate |
|            | exit     |

## 6.16 Operational Mode Commands

**commit** (abort | confirm) [persist-id <id>]

- Abort or confirm a pending confirming commit. A pending confirming commit will also be aborted if the CLI session is terminated without doing commit confirm (default is confirm). If the confirming commit was initiated with a persist argument, then the same token needs to be supplied using the persist-id argument to this command.

**Configure** (private, exclusive, shared)

- Enter configure mode. The default is private.
  - Private - Edit private copy of running configuration.
  - Exclusive - Lock and edit candidate configuration.
  - Shared - Edit candidate configuration without locking it.

**exit**

- Exits the CLI session.

**help** <command>

- Display help text related to <command>.

**ping**

- Ping an IP address or hostname.

**quit**

- Quit current operation.



## request

- Performs a Remote Procedure Call, which instructs the device to perform some operation, i.e., a reboot.

## script

- Script actions..

## set [environment]

- Set environment..

## set-path

- Set relative show path.

## show <command>

- The “show” command can be used to view information. Notice the information displayed is different, depending on which mode the CLI is in. The text which follows shows operational data when the CLI is in operational mode. Note that the following are examples and will vary from one system to the next:

```
> show configuration system
contact      Mark;
name        Orbit1;
location     Tank1;
clock {
  timezone-location America/New_York;
}
ntp {
  use-ntp true;
  ntp-server 216.171.112.36 {
    enabled true;
  }
}
dns {
  server [ 68.94.156.1 68.94.157.1 ];
}
tamper-detection {
  magnetometer {
    enabled false;
  }
}
pre-login-banner "Oil from Tanker1 ";
authentication {
  user-authentication-order [ local-users radius ];
  password-options {
    minimum-length      4;
    minimum-lower-case-letters 2;
    minimum-capital-letters 2;
    minimum-numeric     2;
    minimum-non-alpha-numeric 1;
  }
}
}
```

- Showing configuration data when the CLI is in configuration mode:



```
% show system
name          "Device#42";
location "North_Site"
clock {
  timezone-location America/New_York;
}
geographical-location {
  latitude 43.118376;
  longitude -77.61152;
  altitude 1.0;
}
```

- Normally, only those values explicitly set by the user will be displayed. Users can selectively view those nodes that assumed a default value by using the “details” modifier on the CLI, like the example shown on the next page.
- Showing the user’s configuration and any nodes that assumed a default value:

```
> show configuration interfaces interface ETH1 | details
```

```
type ethernetCsmacd;
enabled true;
ipv4 {
  enabled true;
  ip-forwarding false;
  address 192.168.1.10 {
    prefix-length 24;
  }
}
ipv6 {
  enabled true;
  ip-forwarding false;
  dup-addr-detect-transmits 1;
  autoconf {
    create-global-addresses true;
    create-temporary-addressed false;
    temporary-valid-lifetime 604800;
    temporary-preferred-lifetime 86400;
  }
}
```

- Showing the complete data model that the user has access to, while using additional CLI features:

```
> show configuration | details | display set | nomore
set logging event-rules console_login description ""
set logging event-rules console_login local true
set logging event-rules console_login priority notice
.....
<Remaining text omitted for brevity>
.....
```

**show** [path]

- Display CLI properties..



## ssh

- Open a secure shell on another host

## telnet

- Open a telnet session

## top

- Exit to top level and optionally run command

## traceroute

- Trace the route to a remote host

## up

- Exit one level of configuration

## 6.17 Configure Mode Commands

**annotate** <statement> <text>

- Associate an annotation with a given configuration statement. To remove an annotation, leave the text empty.

**commit** (check | and-quit | confirmed [<timeout>] [persist <token>] to-startup) [comment <text>] [label <text>] [persist-id <id>]

- Commit current configuration to running.

**check** - Validate current configuration.

**and-quit** - Commit to running and quit configure mode.

**confirmed** -Commits the current configuration to running with a timeout. If no commit confirm command has been issued before the timeout expires, then the configuration will be reverted to the configuration that was active before the commit confirmed command was issued. If no timeout is given then the confirming commit will have a timeout period of 10 minutes. The configuration session will be terminated after this command since no further editing is possible. Only available in configure exclusive and configure shared mode.

The confirming commit will be rolled back if the CLI session is terminated before confirming the commit, unless the persist argument is given. If the persist command is given then the CLI session can be terminated and a later session may confirm the pending commit by supplying the persist token as an argument to the commit command using the persist-id argument.

**comment** <text> - Associate a comment with the commit. The comment can later be seen when examining rollback files.

**label** <text> - Associate a label with the commit. The label can later be seen when examining rollback files.

**persist-id** <id> - If a prior confirming commit operation has been performed with the persist argument, then to modify the ongoing confirming commit process the persist-id argument needs to be supplied with the same persist token. This makes it possible to, for example, abort an ongoing persist commit, or extend the timeout.

**compare** running [brief]

- If changes have been made, but have not yet been committed, then those changes can be reviewed prior to committing them by using the “compare” command. Differences will be



annotated with - (removed) and + (added). If the brief option is specified, then only the differences will be shown.

### **copy**

- Copy a list entry.

### **delete**

- Delete a data element.

### **edit**

- Edit a sub-element.

### **exit** (level | configuration-mode)

**level** - Exit from current mode. If performed on the top level, will exit configure mode. This is the default if no option is given.

**configuration-mode** - Exit from configuration mode regardless of mode.

### **help** <command>

- Shows help text for command.

### **insert** <path>

- Inserts a new element. If the element already exists and has the indexed View option set in the data model, then the old element will be renamed to element+1 and the new element inserted in its place.

**insert** <path>[first|last|beforekey|afterkey] - Insert a new element into an ordered list. The element can be added first, last (default), before or after another element.

### **move** <path>[first|last|beforekey|afterkey]

- Move an existing element to a new position in an ordered list. The element can be moved first, last (default), before or after another element.

### **quit**

- Exit from this level.

### **rename** <instance path> <new id>

- Rename an instance.

### **request**

- Make system level requests.

### **resolved**

- Conflicts have been resolved.

### **revert**

- If changes have been made, but have not yet been committed, then those changes can be committed, reverted, or ignored by quitting the configuration mode of the CLI. Reverting the changes can be done using the “revert” command.

### **rollback** [<number>]

- Return the configuration to a previously committed configuration. The system stores a limited number of old configurations. If more than the configured number of configurations are stored,



then the oldest configuration is removed before creating a new one. The most recently committed configuration (the running configuration) is number 0, the next most recent 1, etc.

Example:

```
admin@(none)% rollback 1
[ok][2012-06-19 16:28:55]
```

**run**

- Run an operational-mode command.

**set**

- Set a parameter.

**show**

- Show a parameter.

**status**

- Display users currently editing the configuration.

**tag** <add|clear|del>

**tag** add <statement> <tag> - Add a tag to a configuration statement.

**tag** del <statement> <tag> - Remove a tag from a configuration statement.

**tag** clear <statement> - Remove all tags from a configuration statement.

**top**

- Exit to top level and optionally run command.

**up**

- Exit one level of configuration.

**validate**

- Validates current configuration. This is the same operation as commit check.





## 7.0 APPENDIX B – Integrity Measurement Authority (IMA)

### 7.1 Understanding

The MCR supports the integrity measurement and attestation architecture as described by Trusted Network Connect (TNC) specifications, jointly developed and published by Trusted Computing Group (TCG) and IETF NEA working group.

The MCR establishes secure IPsec VPN connection with the VPN gateway via mutual authentication based on certificates or pre-shared secrets. The TNC architecture adds the ability to measure, report and verify the security state of the MCR (e.g. integrity of critical system configuration file) as a part of IPsec VPN authentication and authorization process.

MCR supports TNCCS 2.0 protocol and subset of TCG's Platform trust Service (PTS). The MCR supports only file measurement capability of the PTS protocol. Also, only measurements for following files are supported:

- /tmp/system.config - This file includes all current system configuration.
- /etc/tnc\_config

Once the unit has been configured, the hash (sha256 or sha385) of system configuration file can be obtained via CLI (locally or remotely) and loaded into the Integrity Measurement Authority (IMA) database.

Typically, integrity measurement and attestation happens automatically as part of IPsec VPN “data” connection establishment using EAP-TTLS method (and EAP-TNC authentication within it) as instructed by the VPN-gateway. However, MCR also supports an out-of-band IMA connection, where the unit connects to a separate IMA server not to pass data but just to perform integrity measurement and attestation. The IMA server, in such a setup, can then publish the unit's “health” information to the VPN server that is terminating the actual data connections. This allows VPN server to enforce permit/deny policy for incoming VPN data connections from the unit.

### 7.2 Configuring

The out of band IMA configuration is exactly similar to VPN configuration described in VPN section except that the IPsec connection is designated specifically as out-of-band IMA connection and local and remote ip subnet are all set 0.0.0.0/0 as shown below:

```
% set services vpn ipsec connection IMA-CONN-1 is-out-of-band-ima true
% set services vpn ipsec connection IMA-CONN-1 local-ip-subnet 0.0.0.0/0
% set services vpn ipsec connection IMA-CONN-1 remote-ip-subnet 0.0.0.0/0
% set services vpn ipsec connection IMA-CONN-1 periodic-retry-interval 60
```

The “periodic-retry-interval” applies only to the IPsec connection designated as an “out-of-band” IMA connection. The MCR attempts attestation every “periodic-retry-interval” if the previous attempt to connect with IMA server was unsuccessful.

In case of an out of band IMA server setup, the MCR needs to be configured with an IMA IPsec connection and a VPN-GWY IPsec connection. An example follows:

```
connection IMA-CONN-1 {
    ike-peer          IMA-SERVER;
    ipsec-policy      IPSEC-POLICY-IMA;
    local-ip-subnet   0.0.0.0/0;
    remote-ip-subnet  0.0.0.0/0;
    is-out-of-band-ima true;
```





```
failure-retry-interval 1;
}
connection VPN-GWY-CONN-1 {
  ike-peer      VPN-GWY;
  ipsec-policy  IPSEC-POLICY-1;
  local-ip-subnet 192.168.1.0/24;
  remote-ip-subnet 192.168.2.0/16;
  failure-retry-interval 1;
}
```

*IMA-CONN-1* is used for attestation and *VPN-GWY-CONN-1* is used for VPN data connection.

If more than one IPsec connection is configured on the unit, the unit initiates connections in round-robin fashion. For example, MCR will follow the following sequence:

- Attempt connection to IMA-SERVER
- Attempt connection to VPN-SERVER (irrespective of IMA-SERVER connection outcome)
- Attempt connection to IMA-SERVER after failure-retry-interval if previous attempt to connect with it failed.
- Attempt connection to IMA-SERVER after periodic-retry-interval if previous attempt to connect with it succeeded.
- Attempt connection to VPN-SERVER after failure-retry-interval if it failed previously or got disconnected due to dead peer detection.
- and so on...

### 7.2.1 Obtaining Configuration File Hash

The following example shows the use of a request to get the system configuration hash:

```
admin@(none) 22:09:59> request services vpn ipsec get-config-hash hash-algo sha384 hash
e60429aa127cb2f23e10ae00b6c1553fa9d1f598b2a206926ad0dcdf9a758622eec77ad559b32f
85ceea9013a961041f
[ok][2013-01-18 22:10:15]
```

This hash can then be loaded in IMA database.

## 7.3 Monitoring

The current attestation status of the IMA connection is displayed using same command as used to display regular VPN data connection status. The example on the following page shows that the IMA connection succeeded but the IMA Evaluation was “non-compliant” and IMA recommendation was “Quarantined”. This will happen is the system configuration file hash loaded in IMA does not match the actual hash of the current system configuration, indicating that system configuration was changed since last time the hash was loaded in the IMA database.

```
> show services vpn
services vpn ipsec ipsec-status connections connection IMA-CONN-1
state          disconnected
failure-reason none
last-timestamp 2013-01-18T21:24:26+00:00
ima-evaluation  “non-compliant major”
ima-recommendation Quarantined
```



Once it is determined through event logs that the configuration was changed by authorized user, the current configuration hash can be loaded in the IMA and then MCR can be instructed to re-attest with IMA server, as shown below.

```
> request service-vpn-ipsec-attest-with-ima conn-name IMA-CONN-1
```

The IMA status can then be checked again periodically for new attestation result:

```
> show services vpn
services vpn ipsec ipsec-status connections connection IMA
state          disconnected
failure-reason none
last-timestamp 2013-01-18T22:19:02+00:00
ima-evaluation  compliant
ima-recommendation "Access Allowed"
```

## 7.4 IMA Troubleshooting

Follow the troubleshooting steps described in VPN section on troubleshooting IMA connection failure. Note that an IMA connection failure means that unit was unable to communicate or attest with IMA. It does not mean there was an IMA evaluation failure.



## 8.0 APPENDIX C – Common Event Expression (CEE)

Events will be categorized using a taxonomy based on the Common Event Expression (CEE) event profile (1). These events will be encoded using JavaScript Object Notation (JSON), and placed into the standard message body of a syslog message.

From the CEE website:

Common Event Expression (CEETM) improves the audit process and the ability of users to effectively interpret and analyze event log and audit data. This is accomplished by defining an extensible unified event structure, which users and developers can leverage to describe, encode, and exchange their CEE Event Records (2).

CEE defines the structure of event messages via an XML schema referred to as the CEE Core Profile. The Core Profile consists of 3 reusable components: (2)

- **Event Taxonomy** — provides a listing of Event Tags that can be used to classify and identify events. The taxonomy supports common event categorization methods and identification of records that pertain to similar types of events.
- **Field Dictionary** — a listing of event record fields and field value types used to represent common event data. Selected fields and value types become associated with properties of a specific event instance.
- **CEE Event Schema** — defines the structure of an event record, including the minimum set of required fields. Event Extensions provide a mechanism for capturing additional data about an event.

One of the key features of the CEE Core Profile is that it can be extended by an organization so that they can add additional taxonomy categories and fields that describe vendor specific events.

### 8.1 Event Taxonomy

The CEE Core Profile defines the following taxonomy categories:

- **Action** — The primary type of action that was undertaken as part of the event. The status or result of the action should be detailed in the status field.
- **Domain** — The environment or domain of the event. Typical event domains include network (net), operating system (os), and application (app).
- **Object** — The type of object that is targeted or otherwise affected by the event
- **Service** — The service the event involves. The service field value provides context to the event action or more precision to the event domain.
- **Status** — The end result or status of the event action identified by the action field.
- **Subject** — The type of object that initiated or started the event action identified by the action field.

With the exception of ‘subject’, the Core Profile defines valid values for each of these categories, some examples of the values include “access, copy, clone, encrypt” for action values, and “error, failure, ongoing, success” for status values.

All taxonomy fields are optional, however if given they *must* contain exactly one non-null value.

### 8.2 Event Field Dictionary

The Core Profile defines a selection of common fields that may be used in event logs. Like the taxonomy categories, this dictionary can be extended by vendors by using a custom profile. All of the defined fields are optional with the exception of the following 3 mandatory fields that must be in every logged event:

- host – Hostname of the event source.
- pname – Process name that generated the event.



- time – Event start time

It may appear that having the time field is redundant, as the time is already in the syslog message; this is false for 2 reasons:

1. RFC 3164 (3) Syslog timestamps do not contain the year, and only have second resolution, whereas the CEE timestamps have microsecond resolution with full year. RFC 5424 (4) Syslog messages do include the year and support for microsecond resolution
2. Syslog timestamps reflect the time that the event was sent to syslog, not necessarily the time that the event occurred. Depending on the situation, these times may be different

## 8.3 Event Encoding & Transport

CEE defines two different methods for encoding events for transport and storage, XML and JSON. CEE also explicitly defines how CEE messages are to be transported over syslog (5). The following requirements are stated:

- Syslog Header – The standard Syslog header MUST be used.
- Syslog Body – The CEE Event MUST be represented using the CLS (CEE common Log Syntax) JSON Encoding.
- CEE Event Flag – The beginning of the encoded CEE Event MUST be identified by the CEE Event Flag. Within Syslog, the CEE Event Flag is @cee:
- Character Encoding – If the syslog implementation is only 7-bit, all characters not in the ASCII character set MUST be escaped.

### 8.3.1 Examples

A valid CEE JSON Event Record embedded within an RFC5424 Syslog transport:

```
<165>1 2011-12-20T12:38:06Z 10.10.0.1 process - example-event-1
@cee:{"pname":"auth","host":"system.example.com","time":"2011-12-20T12:38:05.123456-05:00"}
```

A valid CEE JSON Event Record used with a “legacy” Syslog transport:

```
<0>Dec 20 12:42:20 syslog-relay process[35]: @cee:
{"crit":123,"id":"abc","appname":"application","pname":"auth","pid":123,"host":"system.example.com","pri":10,"time":"2011-12-20T12:38:05.123456-05:00","action":"login","domain":"app","object":"account","service":"web","status":"success"}
```

The following example shows a series of events that may be generated by a host requesting an IP for its eth0 interface from a DHCP server (Syslog header left off for brevity, and formatted for clarity):

DHCP Request sent to the server:

```
@cee: {
  "host":"stout",
  "pname":" my_appname ",
  "time":"2012-08-22T11:20:10.559227-04:00",
  "action":"request",
  "domain":"net",
  "object":"interface",
  "service":"dhcp_client",
  "status":"ongoing",
  "event":"dhcp_client",
  "interface_name":"eth0",
  "profile":http://gemds.com/cee\_profile/1.0beta1.xsd
}
```



DHCP Response from server, assigning the IP 192.168.2.3:

```
@cee: {
  "host":"stout",
  "pname":"my_appname",
  "time":"2012-08-22T11:20:10.559748-04:00",
  "action":"request",
  "domain":"net",
  "object":"interface",
  "service":"dhcp_client",
  "status":"success",
  "ipv4":"192.168.2.3",
  "event":"dhcp_client",
  "interface_name":"eth0",
  "profile":http://gemds.com/cee_profile/1.0beta1.xsd
}
```

The body of syslog messages of type “alert” is specified using RFC 5425 type key/value pairs. A few additional fields are also present.

### 8.3.2 syslog PRIVAL

The “PRIVAL” field of the syslog “HEADER” shall to be set to 113 for alerts and between 104 and 111 for editable events.

### 8.3.3 syslog APP-NAME

The “APP-NAME” field of the “HEADER” specified in the syslog RFC shall be set to “csmgr”.

RFC5424 states: “The APP-NAME field SHOULD identify the device or application that originated the message.” The semantics of the field have changed from the application that originated the event, to the application who should receive the event.

### 8.3.4 syslog MSG

For events of type audit, the msg is vendor specific, whereas events of type alert must be in a specified format which contains a GUID, level and message. Using the CEE approach all of the requested information would be present in all messages.

Example of message using format

```
Jun 7 11:10:22 ccc99 csmgr[27417]: Source=' ABCDEF0123456789AB00000000000099'
Level='5' Message='Date/Time Changed by User'
```

Example of message using CEE format

```
Jun 7 11:10:22 ccc99 systemmgr[33212]: @cee: {"host":"ccc99","guid":"
ABCDEF0123456789AB00000000000099","syslog_priority":5,
"pname":"systemmgr","time":"2012-08-23T09:16:21.335592-
04:00","action":"modify","domain":"os","object":"datetime",
"status":"success","event":"date_time_from_user","profile":"http://gemds.com/cee_profile/
1.0beta1.xsd"}
```

## 8.4 Configuring

The following shows how to configure the unit with a server to which events will be sent:

```
% set logging syslog server my_syslog_server ip 192.168.1.1 port 1999 protocol tls version
RFC5424 tls-options tls-ca-certificate my_ca_cert tls-client-certificate my_client_cert tls-
client-key my_client_key
```



The following shows how to configure an event that will be logged locally, via syslog, and via netconf-notifications:

```
% set logging event-rules cell_connected syslog true local true netconf-notification true
```

## 8.5 Monitoring

Ensure the CLI is in operational mode. Follow the example below to view the state and statistics:

```
% show logging event-rules cell_connected  
description      "cell connection established";  
local           true;  
priority         notice;  
syslog-facility user;  
syslog          true;  
snmp-notification true;  
netconf-notification true;  
  
% show logging event-rules cell_disconnected  
description      "cell connection disconnected";  
local           true;  
priority         notice;  
syslog-facility user;  
syslog          true;  
snmp-notification true;  
netconf-notification true;
```



## 9.0 APPENDIX D – Managing Signed Firmware

The GE MDS code signing tool (CST) is a command line program that can be run on Windows or Linux. Running the CST and passing the “--help” argument will print the following usage info:

```
pkgsigner --help
```

```
GEMDS Firmware Packaging Signing Utility (pkgsigner) 06-6671A01 Rev. 0.3.0  
Built: Jan 7 2013 11:25:34
```

**Usage:**

**To verify and sign a package:**

```
pkgsigner -v verifycert -k privkey -P password -p pubcert -f infile -o outfile
```

**where:** verifycert = The filepath a public certificate to be used to verify the signature of the infile if and the infile has been previously signed.

privkey = The filepath for the private key to be used to create a signed package.

password = The optional password, if the private key is encrypted

pubcert = The filepath for the public certificate corresponding to the privkey. This is used to store a hash of the certificate information, to aid lookup of the appropriate public key during signature verification

infile = The filepath for package file (input)

outfile = The filepath for signed package file (output)

**To display package info and verification status:**

```
pkgsigner -l -v verifycert -f infile
```

**where:** verifycert = The filepath a public certificate to be used to verify the signature of the infile if and the infile has been previously signed.

infile = The filepath for package file (input)

Users can verify that a firmware package file came from GE MDS by using the CST. The following example shows how to verify a signed firmware package file came from GE MDS by using the firmware file ge\_signed\_package.mpk and by using the GE MDS provided public certificate ge\_pubcert.pem.

```
./pkgsigner -l -v ge_pubcert.pem -f ge_signed_package.mpk  
Processing file: 'ge_signed_package.mpk'  
Package ID: 20121101  
NumImages: 4  
NumSignatures: 1  
Image #0 : Bootloader version 2012.07-g644d99  
Image #1 : Kernel version 3.0.15-mds-gc00  
Image #2 : RootFS version 0.0.4  
Image #3 : CompFS version 0.0.0  
Package version: 0.0.4
```

Signature #1 validation was successful.



Signing a GE MDS firmware package is an optional step for users and is not required. Users may wish to sign a firmware package to ensure that only user-approved firmware package revisions from GE MDS can be loaded into a unit. An example of signing a firmware package is shown below:

```
./pkg signer -v ge_pubcert.pem -k user_key.pem -P "mypass" -p user_pubcert.pem -f  
ge_signed_package.mpk -o user_signed_package.mpk
```

```
Processing file: 'ge_signed_package.mpk'  
Package ID: 20121101  
NumImages: 4  
NumSignatures: 1  
Image #0 : Bootloader version 2012.07-g644d99  
Image #1 : Kernel version 3.0.15-mds-gc00  
Image #2 : RootFS version 0.0.4  
Image #3 : CompFS version 0.0.0  
Package version: 0.0.4
```

**Signature #1 validation was successful.**

**Packed file created in 'user\_signed\_package.mpk'.**

Where:

- `ge_signed_package.mpk` is the firmware package provided by GE MDS that was signed by GE MDS. Firmware packages will typically be downloaded by users from GE MDS websites.
- `ge_pubcert.pem` is the public certificate provided by GE MDS that is used to verify that the signed packaged is authentic. The GE MDS public certificate will typically be downloaded by users from the GE MDS website.
- `user_key.pem` is a private key provided by the user.
- `mypass` is the password used to decrypt `user_key.pem`, assuming the key is password protected. If the key is not password protected, then the `-P` option may be omitted.
- `user_pubcert.pem` is the public certificate corresponding to `user_key.pem`.
- `user_signed_package.mpk` the file that will be created that contains the GE MDS signature and the newly appended user signature.

When verifying a user-signed package, both the GE MDS public certificate and the user's public certificate must be provided to the CST:

```
./pkg signer -l -v ge_pubcert.pem -v user_pubcert.pem -f user_signed_package.mpk
```

```
Processing file: 'user_signed_package.mpk'  
Package ID: 20121101  
NumImages: 4  
NumSignatures: 2  
Image #0 : Bootloader version 2012.07-g644d99  
Image #1 : Kernel version 3.0.15-mds-gc00  
Image #2 : RootFS version 0.0.4  
Image #3 : CompFS version 0.0.0  
Package version: 0.0.4
```

**Signature #2 validation was successful.**

**Signature #1 validation was successful.**





## 10.0 APPENDIX E – Obtaining Provisioned 4G/LTE Service (Verizon)

### 10.1 Understanding

The MDS Orbit MCR-4G requires a mini SIM card (2FF type) provisioned for 4G cell operation. The unit's cellular interface will not function without a valid SIM card installed.

GE MDS does not provide SIM cards. Service can be obtained by contacting Verizon and requesting a provisioned SIM card for the appropriate M2M service plan.

Description of the SIM port and how to insert a SIM card is provided in Figure 3-22. Steps for Inserting the SIM Card on Page 66.

### 10.2 Before Contacting Verizon

To enable service, Verizon will typically require the IMEI (International Mobile Equipment Identity) of the equipment in which the SIM card will be used.

The IMEI can be found by logging into the device and entering the following command:

```
> show interfaces-state interface Cell cell-status imei  
cell-status imei 991000947608727
```

If MEID (Mobile Equipment Identifier) is needed, this is equal to the IMEI value *minus the last digit*.

---

**NOTE** Do not run the command above unless a provisioned SIM card is installed in the unit. If an unprovisioned card is used, the cell-status may return an error code beginning with 0x instead of the proper IMEI value.

---

### 10.3 Establishing a Cell Service Plan

Verizon offers a variety of service plans. Determine your data needs and contact your Verizon Wireless Business Representative to obtain the appropriate provisioned SIM cards.

Verizon provides the following link to assist in finding a service representative based on customer attributes and needs: <https://www.findmyrep.vzw.com/>



# 11.0 APPENDIX F – NX915 Module Frequencies

The NX915 module is a Frequency-Hopping Spread Spectrum (FHSS) radio that can be configured to operate in a subset of all available frequencies for a particular modem mode (125kbps, 250kbps, 500kbps, etc). The radio frequency will change at the "Dwell Time" rate, a default of 50ms.

The table below illustrates the discrete frequencies (or channels) that can be user configured. The selected "hop-set" defines the specific channels of radio operation.

**NOTE** The module may be configured for by the factory to disallow operation in specific frequencies to meet country specific regulatory requirements. These settings can NOT be changed or modified by the user.

When specific hop-set can be user configured that defines a specific collection of radio operation.

The following table show the number of discrete frequencies (or channels) available for each modem type based on the selected hop set

| Channel | Frequency  | Modem-Mode |     |     |      |       |      |
|---------|------------|------------|-----|-----|------|-------|------|
|         |            | 125        | 250 | 500 | 1000 | 1000W | 1250 |
| 0       | 902.700000 | A          | A   | A   | A    | A     | A    |
| 1       | 903.007500 | A          | A   | B   | B    | B     | B    |
| 2       | 903.315000 | A          | A   | C   | C    | C     | C    |
| 3       | 903.622500 | A          | A   | A   | D    | D     | D    |
| 4       | 903.930000 | A          | A   | B   | A    | E     | E    |
| 5       | 904.237500 | A          | A   | C   | B    | A     | F    |
| 6       | 904.545000 | A          | A   | A   | C    | B     | A    |
| 7       | 904.852500 | A          | A   | B   | D    | C     | B    |
| 8       | 905.160000 | A          | A   | C   | A    | D     | C    |
| 9       | 905.467500 | A          | A   | A   | B    | E     | D    |
| 10      | 905.775000 | A          | A   | B   | C    | A     | E    |
| 11      | 906.082500 | A          | A   | C   | D    | B     | F    |
| 12      | 906.390000 | A          | A   | A   | A    | C     | A    |
| 13      | 906.697500 | A          | A   | B   | B    | D     | B    |
| 14      | 907.005000 | A          | A   | C   | C    | E     | C    |
| 15      | 907.312500 | A          | A   | A   | D    | A     | D    |
| 16      | 907.620000 | A          | A   | B   | A    | B     | E    |
| 17      | 907.927500 | A          | A   | C   | B    | C     | F    |
| 18      | 908.235000 | A          | A   | A   | C    | D     | A    |
| 19      | 908.542500 | A          | A   | B   | D    | E     | B    |
| 20      | 908.850000 | A          | A   | C   | A    | A     | C    |
| 21      | 909.157500 | A          | A   | A   | B    | B     | D    |
| 22      | 909.465000 | A          | A   | B   | C    | C     | E    |
| 23      | 909.772500 | A          | A   | C   | D    | D     | F    |
| 24      | 910.080000 | A          | A   | A   | A    | E     | A    |
| 25      | 910.387500 | A          | A   | B   | B    | A     | B    |
| 26      | 910.695000 | A          | A   | C   | C    | B     | C    |



|    |            |        |   |   |   |   |   |
|----|------------|--------|---|---|---|---|---|
| 27 | 911.002500 | A      | A | A | D | C | D |
| 28 | 911.310000 | A      | A | B | A | D | E |
| 29 | 911.617500 | A      | A | C | B | E | F |
| 30 | 911.925000 | A      | A | A | C | A | A |
| 31 | 912.232500 | A      | A | B | D | B | B |
| 32 | 912.540000 | A      | A | C | A | C | C |
| 33 | 912.847500 | A      | A | A | B | D | D |
| 34 | 913.155000 | A      | A | B | C | E | E |
| 35 | 913.462500 | A      | A | C | D | A | F |
| 36 | 913.770000 | A      | A | A | A | B | A |
| 37 | 914.077500 | A      | A | B | B | C | B |
| 38 | 914.385000 | A      | A | C | C | D | C |
| 39 | 914.692500 | A      | A | A | D | E | D |
| 40 | 915.000000 | A      | A | B | A | A | E |
| 41 | 915.307500 | A      | A | C | B | B | F |
| 42 | 915.615000 | A      | A | A | C | C | A |
| 43 | 915.922500 | A      | A | B | D | D | B |
| 44 | 916.230000 | A      | A | C | A | E | C |
| 45 | 916.537500 | A      | A | A | B | A | D |
| 46 | 916.845000 | A      | A | B | C | B | E |
| 47 | 917.152500 | A      | A | C | D | C | F |
| 48 | 917.460000 | A      | A | A | A | D | A |
| 49 | 917.767500 | A      | A | B | B | E | B |
| 50 | 918.075000 | A      | A | C | C | A | C |
| 51 | 918.382500 | A      | A | A | D | B | D |
| 52 | 918.690000 | A      | A | B | A | C | E |
| 53 | 918.997500 | A      | A | C | B | D | F |
| 54 | 919.305000 | A      | A | A | C | E | A |
| 55 | 919.612500 | A      | A | B | D | A | B |
| 56 | 919.920000 | Unused |   |   |   |   |   |
| 57 | 920.227500 | A      | A | A | B | C | D |
| 58 | 920.535000 | A      | A | B | C | D | E |
| 59 | 920.842500 | A      | A | C | D | E | F |
| 60 | 921.150000 | A      | A | A | A | A | A |
| 61 | 921.457500 | A      | A | B | B | B | B |
| 62 | 921.765000 | A      | A | C | C | C | C |
| 63 | 922.072500 | A      | A | A | D | D | D |
| 64 | 922.380000 | A      | A | B | A | E | E |
| 65 | 922.687500 | A      | A | C | B | A | F |
| 66 | 922.995000 | A      | A | A | C | B | A |
| 67 | 923.302500 | A      | A | B | D | C | B |



|    |            |   |   |   |   |   |   |
|----|------------|---|---|---|---|---|---|
| 68 | 923.610000 | A | A | C | A | D | C |
| 69 | 923.917500 | A | A | A | B | E | D |
| 70 | 924.225000 | A | A | B | C | A | E |
| 71 | 924.532500 | A | A | C | D | B | F |
| 72 | 924.840000 | A | A | A | A | C | A |
| 73 | 925.147500 | A | A | B | B | D | B |
| 74 | 925.455000 | A | A | C | C | E | C |
| 75 | 925.762500 | A | A | A | D | A | D |
| 76 | 926.070000 | A | A | B | A | B | E |
| 77 | 926.377500 | A | A | C | B | C | F |
| 78 | 926.685000 | A | A | A | C | D | A |
| 79 | 926.992500 | A | A | B | D | E | B |
| 80 | 927.300000 | A | A | C | A | A | C |

**Channels/Hop Set**

|          |    |    |    |    |    |    |
|----------|----|----|----|----|----|----|
| <b>A</b> | 80 | 80 | 27 | 20 | 17 | 14 |
| <b>B</b> | 0  | 0  | 27 | 20 | 15 | 14 |
| <b>C</b> | 0  | 0  | 26 | 20 | 16 | 13 |
| <b>D</b> | 0  | 0  | 0  | 20 | 16 | 13 |
| <b>E</b> | 0  | 0  | 0  | 0  | 16 | 13 |
| <b>F</b> | 0  | 0  | 0  | 0  | 0  | 13 |



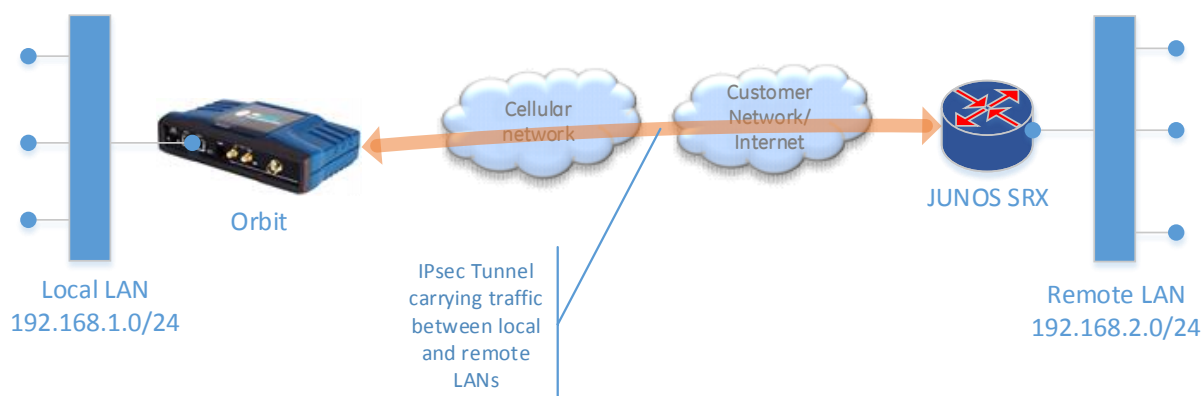
## 12.0 APPENDIX G- VPN Configuration Examples

The commands listed in this section can be copy-n-pasted in the Orbit CLI (in configuration mode) followed by “commit” to save the changes. Please turn off CLI autowizard before pasting in the commands as shown below:

```
admin@(none) 18:26:51> config
admin@(none) 18:26:53% run set autowizard false
admin@(none) 18:27:03%
```

### 12.1 Policy-Based IPsec VPN with Juniper JUNOS

In this example we describe a sample configuration for a site-to-site policy based IPsec VPN setup between Orbit MCR (2E1S) and Juniper SRX240 JUNOS appliance with IKEv2 pre-shared key based authentication.



The WAN IP address of SRX240 is 172.18.175.40 and Orbit cell ip address is 172.18.175.138.

#### 12.1.1 Orbit

##### 12.1.1.1 Configuration

###### # Bridge/LAN interface configuration

```
set interfaces interface Bridge type bridge
set interfaces interface Bridge ipv4 address 192.168.1.1 prefix-length 24
set interfaces interface Bridge filter input IN_TRUSTED
set interfaces interface Bridge filter output OUT_TRUSTED
set interfaces interface Bridge bridge-settings members port ETH1
set interfaces interface Bridge bridge-settings members port ETH2
```

###### # Cell interface configuration

```
set interfaces interface Cell type cellular
set interfaces interface Cell enabled true
set interfaces interface Cell ipv4 dhcp point-to-point-connection true
```



```
set interfaces interface Cell filter input IN_UNTRUSTED
set interfaces interface Cell filter output OUT_UNTRUSTED
set interfaces interface Cell cell-config connection-profile PROFILE-1 bearer-config apn <CUSTOMER-APN>
```

#### # IKE/IPsec configuration

```
set services vpn enabled true
set services vpn ike policy SRX240-IKE-POLICY auth-method pre-shared-key
set services vpn ike policy SRX240-IKE-POLICY pre-shared-key test123
set services vpn ike policy SRX240-IKE-POLICY ciphersuite CS1 encryption-algo aes128-cbc
set services vpn ike policy SRX240-IKE-POLICY ciphersuite CS1 mac-algo sha256-hmac
set services vpn ike policy SRX240-IKE-POLICY ciphersuite CS1 dh-group dh14
set services vpn ike peer SRX240-IKE-PEER ike-policy SRX240-IKE-POLICY
set services vpn ike peer SRX240-IKE-PEER local-identity default
set services vpn ike peer SRX240-IKE-PEER peer-endpoint address 172.18.175.40
set services vpn ike peer SRX240-IKE-PEER peer-identity default
set services vpn ike peer SRX240-IKE-PEER role initiator
set services vpn ipsec policy SRX240-IPSEC-POLICY ciphersuite CS1 encryption-algo aes128-cbc
set services vpn ipsec policy SRX240-IPSEC-POLICY ciphersuite CS1 mac-algo sha256-hmac
set services vpn ipsec policy SRX240-IPSEC-POLICY ciphersuite CS1 dh-group dh14
set services vpn ipsec connection SRX240 ike-peer SRX240-IKE-PEER
set services vpn ipsec connection SRX240 ipsec-policy SRX240-IPSEC-POLICY
set services vpn ipsec connection SRX240 local-ip-subnet 192.168.1.0/24
set services vpn ipsec connection SRX240 remote-ip-subnets [ 192.168.2.0/24 ]
set services vpn ipsec connection SRX240 filter input IN_TRUSTED
set services vpn ipsec connection SRX240 filter output OUT_TRUSTED
```

#### # Firewall configuration

```
set services firewall enabled true
set services firewall address-set CELL-IP
set services firewall filter IN_TRUSTED rule 10 match protocol all
set services firewall filter IN_TRUSTED rule 10 actions
set services firewall filter IN_TRUSTED rule 10 actions action accept
set services firewall filter IN_UNTRUSTED rule 1 match protocol icmp
set services firewall filter IN_UNTRUSTED rule 1 actions
set services firewall filter IN_UNTRUSTED rule 1 actions action accept
set services firewall filter IN_UNTRUSTED rule 2 match protocol udp
set services firewall filter IN_UNTRUSTED rule 2 match src-port
set services firewall filter IN_UNTRUSTED rule 2 match src-port services [ dns ]
set services firewall filter IN_UNTRUSTED rule 10 match protocol udp
set services firewall filter IN_UNTRUSTED rule 10 match dst-port
set services firewall filter IN_UNTRUSTED rule 10 match dst-port services [ ike ntp ]
```



```
set services firewall filter IN_UNTRUSTED rule 10 actions
set services firewall filter IN_UNTRUSTED rule 10 actions action accept
set services firewall filter IN_UNTRUSTED rule 11 match protocol esp
set services firewall filter IN_UNTRUSTED rule 11 actions
set services firewall filter IN_UNTRUSTED rule 11 actions action accept
set services firewall filter IN_UNTRUSTED rule 12 match protocol all
set services firewall filter IN_UNTRUSTED rule 12 actions
set services firewall filter IN_UNTRUSTED rule 12 actions action drop
set services firewall filter OUT_TRUSTED rule 10 match protocol all
set services firewall filter OUT_TRUSTED rule 10 actions
set services firewall filter OUT_TRUSTED rule 10 actions action accept
set services firewall filter OUT_UNTRUSTED rule 1 match src-address
set services firewall filter OUT_UNTRUSTED rule 1 match src-address address-set CELL-IP
set services firewall filter OUT_UNTRUSTED rule 1 match src-address add-interface-address true
set services firewall filter OUT_UNTRUSTED rule 1 actions
set services firewall filter OUT_UNTRUSTED rule 1 actions action accept
set services firewall filter OUT_UNTRUSTED rule 2 match protocol all
set services firewall filter OUT_UNTRUSTED rule 2 actions
set services firewall filter OUT_UNTRUSTED rule 2 actions action drop
```

### 12.1.1.2 Status

> **show services vpn**

```
services vpn ike security-associations security-association 1
name          SRX240
state         ESTABLISHED
local-host    172.18.175.138
local-id      172.18.175.138
remote-host   172.18.175.40
remote-id     172.18.175.40
initiator     true
initiator-spi 6fae9c7ca839c195
responder-spi 63568d4ca1c3d071
ciphersuite   AES_CBC-128/HMAC_SHA2_256_128/PRF_HMAC_SHA2_256/MODP_2048
established-time 1
rekey-time    9899
reauth-time   0
services vpn ipsec security-associations security-association 1
name          SRX240
state         INSTALLED
mode          TUNNEL
```



```
udp-encap false
in-spi c4bfce67
out-spi ef7c6bd3
ciphersuite AES_CBC-128/HMAC_SHA2_256_128
in-bytes 0
in-packets 0
in-last-use 1619592
out-bytes 0
out-packets 0
out-last-use 0
rekey-time 2704
life-time 3599
install-time 1
local-ts 192.168.1.0/24
remote-ts 192.168.2.0/24
```

## 12.1.2 JUNOS

### 12.1.2.1 Configuration

The configuration below assumes that interface ge-0/0/0 is the external WAN interface and vlan.0 is the VLAN interface that includes all LAN ports.

#### # IKE/IPsec configuration

```
set security ike proposal IKE-PROP-PSK authentication-method pre-shared-keys
set security ike proposal IKE-PROP-PSK dh-group group14
set security ike proposal IKE-PROP-PSK authentication-algorithm sha-256
set security ike proposal IKE-PROP-PSK encryption-algorithm aes-128-cbc
set security ike policy IKE-POLICY-PSK proposals IKE-PROP-PSK
set security ike policy IKE-POLICY-PSK pre-shared-key ascii-text test123
set security ike gateway ORBIT138 ike-policy IKE-POLICY-PSK
set security ike gateway ORBIT138 address 172.18.175.138
set security ike gateway ORBIT138 local-identity inet 172.18.175.40
set security ike gateway ORBIT138 external-interface ge-0/0/0
set security ike gateway ORBIT138 version v2-only
set security ipsec proposal IPSEC-PROP protocol esp
set security ipsec proposal IPSEC-PROP authentication-algorithm hmac-sha-256-128
set security ipsec proposal IPSEC-PROP encryption-algorithm aes-128-cbc
set security ipsec policy IPSEC-POLICY perfect-forward-secrecy keys group14
set security ipsec policy IPSEC-POLICY proposals IPSEC-PROP
set security ipsec vpn ORBIT138 ike gateway ORBIT138
set security ipsec vpn ORBIT138 ike ipsec-policy IPSEC-POLICY
```





### # Security zone configuration

```

set security zones security-zone TRUST address-book address LOCAL-NET-1 192.168.2.0/24
set security zones security-zone TRUST host-inbound-traffic system-services all
set security zones security-zone TRUST interfaces vlan.0
set security zones security-zone UNTRUST address-book address ORBIT138-NET-1 192.168.1.0/24
set security zones security-zone UNTRUST host-inbound-traffic system-services ike
set security zones security-zone UNTRUST host-inbound-traffic system-services ping
set security zones security-zone UNTRUST host-inbound-traffic system-services ntp
set security zones security-zone UNTRUST interfaces ge-0/0/0.0

```

### # Security policies

```

set security policies from-zone TRUST to-zone UNTRUST policy ORBIT138-NET-1-SA match source-address LOCAL-NET-1
set security policies from-zone TRUST to-zone UNTRUST policy ORBIT138-NET-1-SA match destination-address ORBIT138-NET-1
set security policies from-zone TRUST to-zone UNTRUST policy ORBIT138-NET-1-SA match application any
set security policies from-zone TRUST to-zone UNTRUST policy ORBIT138-NET-1-SA then permit tunnel ipsec-vpn ORBIT138
set security policies from-zone UNTRUST to-zone TRUST policy ORBIT138-NET-1-SA match source-address ORBIT138-NET-1
set security policies from-zone UNTRUST to-zone TRUST policy ORBIT138-NET-1-SA match destination-address LOCAL-NET-1
set security policies from-zone UNTRUST to-zone TRUST policy ORBIT138-NET-1-SA match application any
set security policies from-zone UNTRUST to-zone TRUST policy ORBIT138-NET-1-SA then permit tunnel ipsec-vpn ORBIT138

```

### 12.1.2.2 Status

#### > show security ike security-associations

| Index   | State | Initiator cookie | Responder cookie | Mode  | Remote Address |
|---------|-------|------------------|------------------|-------|----------------|
| 1948863 | UP    | 95c139a87c9cae6f | 71d0c3a14c8d5663 | IKEv2 | 172.18.175.138 |

#### > show security ipsec security-associations

Total active tunnels: 1

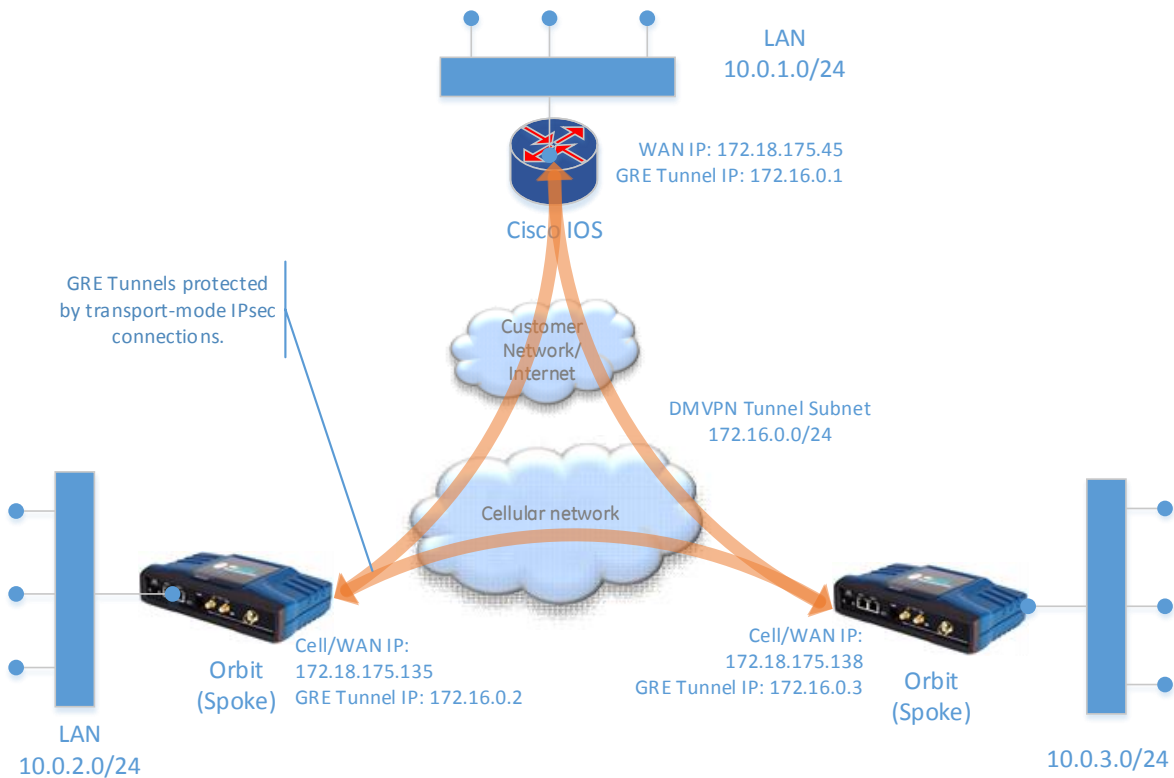
| ID      | Algorithm          | SPI      | Life:sec/kb | Mon vsys | Port       | Gateway        |
|---------|--------------------|----------|-------------|----------|------------|----------------|
| <131074 | ESP:aes-128/sha256 | ef7c6bd3 | 3522/       | unlim    | - root 500 | 172.18.175.138 |
| >131074 | ESP:aes-128/sha256 | c4bfce67 | 3522/       | unlim    | - root 500 | 172.18.175.138 |

## 12.2 DMVPN with Cisco IOS

In this example we describe a sample configuration for a DMVPN between Orbit MCR (2E1S) and Cisco ISR 1941 router with IKEv2 public-key based authentication using RSA certificates generated from 3-tier



PKI. That is, there are 3 CAs- Root CA->Sub CA-1->Sub CA-2. The Orbit client certificate is issued by Sub CA-2.



In example below, we disable default route over Cell and instead setup BGP dynamic routing that advertises the local LAN network to the IOS router and received default route over the GRE tunnel form IOS router.

## 12.2.1 Orbit

### 12.2.1.1 Configuration

#### # NTP configuration

```
set system ntp use-ntp true
set system ntp ntp-server 172.18.175.62
```

#### # Bridge/LAN interface configuration

```
set interfaces interface Bridge type bridge
set interfaces interface Bridge ipv4 address 10.0.3.0 prefix-length 24
set interfaces interface Bridge filter input IN_TRUSTED
set interfaces interface Bridge filter output OUT_TRUSTED
set interfaces interface Bridge bridge-settings members port ETH1
set interfaces interface Bridge bridge-settings members port ETH2
```

#### # Cell interface configuration



**# Ensure that the MTU configured on WAN interface of IOS router matches the cell interface MTU (default=1428).**

set interfaces interface Cell type cellular

set interfaces interface Cell enabled true

**# Disable default route over Cell interface**

set interfaces interface Cell ipv4 dhcp request-routers false

set interfaces interface Cell ipv4 dhcp point-to-point-connection true

set interfaces interface Cell filter input IN\_UNTRUSTED

set interfaces interface Cell filter output OUT\_UNTRUSTED

set interfaces interface Cell cell-config connection-profile PROFILE-1 bearer-config apn <CUSTOMER-APN>

**# IKE/IPsec Configuration**

set services vpn enabled true

set services vpn ike policy DMVPN-CERT version ikev2

set services vpn ike policy DMVPN-CERT auth-method pub-key

set services vpn ike policy DMVPN-CERT pki cert-type rsa

**# Client certificate is installed as ID1**

set services vpn ike policy DMVPN-CERT pki cert-id ID1

**# Client private key pair is generated as ID1**

set services vpn ike policy DMVPN-CERT pki key-id ID1

**# Root CA certificayte is installed as CA1**

set services vpn ike policy DMVPN-CERT pki ca-cert-id CA1

**# Sub CA certificates are installed as SUBCA1 and SUBCA2.**

set services vpn ike policy DMVPN-CERT pki sub-ca-cert-ids [SUBCA1 SUBCA2 ]

set services vpn ike policy DMVPN-CERT ciphersuite CS1 encryption-algo aes256-cbc

set services vpn ike policy DMVPN-CERT ciphersuite CS1 mac-algo sha1-hmac

set services vpn ike policy DMVPN-CERT ciphersuite CS1 dh-group dh5

set services vpn ike peer DMVPN ike-policy DMVPN-CERT

set services vpn ike peer DMVPN peer-endpoint any

set services vpn ike peer DMVPN role responder

set services vpn ipsec policy DMVPN ciphersuite CS1 encryption-algo aes256-cbc

set services vpn ipsec policy DMVPN ciphersuite CS1 mac-algo sha1-hmac

set services vpn ipsec connection DMVPN ike-peer DMVPN

set services vpn ipsec connection DMVPN ipsec-policy DMVPN

set services vpn ipsec connection DMVPN host-to-host

set services vpn ipsec connection DMVPN filter input IN\_TRUSTED

set services vpn ipsec connection DMVPN filter output OUT\_TRUSTED

**# Multipoint GRE tunnel configuration**

set interfaces interface GRE1 type gre



```
set interfaces interface GRE1 enabled true
set interfaces interface GRE1 gre-config mode ip-over-gre
set interfaces interface GRE1 gre-config src-address 0.0.0.0
set interfaces interface GRE1 gre-config dst-address 0.0.0.0
# Ensure that the key matches with one configured on GRE tunnel on IOS router.
set interfaces interface GRE1 gre-config key 10000
set interfaces interface GRE1 gre-config ipsec-connection DMVPN
# Ensure that the MTU matches with one configured on GRE tunnel on IOS router.
set interfaces interface GRE1 ipv4 mtu 1346
set interfaces interface GRE1 ipv4 address 172.16.0.3 prefix-length 24
set interfaces interface GRE1 filter input IN_TRUSTED
set interfaces interface GRE1 filter output OUT_TRUSTED
```

#### **# NHRP service configuration**

```
set services nhrp enabled true
set services nhrp interface Bridge shortcut-destination
set services nhrp interface GRE1 map HUB protocol-address 172.16.0.1
set services nhrp interface GRE1 map HUB protocol-netmask 255.255.255.0
set services nhrp interface GRE1 map HUB nbma-address 172.18.175.45
set services nhrp interface GRE1 map HUB register true
set services nhrp interface GRE1 map HUB cisco true
set services nhrp interface GRE1 authentication cisco123
set services nhrp interface GRE1 holding-time 300
```

#### **# BGP routing configuration**

**# This configuration exports the local LAN network to the IOS router and imports default route over the GRE tunnel from the IOS router.**

```
set routing router-id 172.16.0.3
set routing route-filter LOCAL-LAN rule 1 match outgoing-interface Bridge
set routing route-filter LOCAL-LAN rule 1 actions action accept
```

#### **# Following static route allows Orbit to reach the IOS router**

```
set routing static-routes ipv4 route 1 outgoing-interface Cell
set routing static-routes ipv4 route 1 dest-prefix 172.18.175.0/24
set routing bgp neighbor PRIMARY-HUB peer-address 172.16.0.1
set routing bgp neighbor PRIMARY-HUB enabled true
```

#### **# Following export filter enables the local LAN subnet to be advertised to the IOS router**

```
set routing bgp neighbor PRIMARY-HUB export-filter LOCAL-LAN
set routing bgp neighbor PRIMARY-HUB local-as 65550
set routing bgp neighbor PRIMARY-HUB peer-as 65500
set routing bgp neighbor PRIMARY-HUB hold-time 30
set routing bgp neighbor PRIMARY-HUB keepalive-time 10
```



## # Firewall configuration

```
set services firewall enabled true
set services firewall address-set CELL-IP
set services firewall filter IN_TRUSTED rule 10 match protocol all
set services firewall filter IN_TRUSTED rule 10 actions
set services firewall filter IN_TRUSTED rule 10 actions action accept
set services firewall filter IN_UNTRUSTED rule 1 match protocol icmp
set services firewall filter IN_UNTRUSTED rule 1 actions
set services firewall filter IN_UNTRUSTED rule 1 actions action accept
set services firewall filter IN_UNTRUSTED rule 2 match protocol udp
set services firewall filter IN_UNTRUSTED rule 2 match src-port
set services firewall filter IN_UNTRUSTED rule 2 match src-port services [ dns ]
set services firewall filter IN_UNTRUSTED rule 10 match protocol udp
set services firewall filter IN_UNTRUSTED rule 10 match dst-port
set services firewall filter IN_UNTRUSTED rule 10 match dst-port services [ ike ntp ]
set services firewall filter IN_UNTRUSTED rule 10 actions
set services firewall filter IN_UNTRUSTED rule 10 actions action accept
set services firewall filter IN_UNTRUSTED rule 11 match protocol esp
set services firewall filter IN_UNTRUSTED rule 11 actions
set services firewall filter IN_UNTRUSTED rule 11 actions action accept
set services firewall filter IN_UNTRUSTED rule 12 match protocol all
set services firewall filter IN_UNTRUSTED rule 12 actions
set services firewall filter IN_UNTRUSTED rule 12 actions action drop
set services firewall filter OUT_TRUSTED rule 10 match protocol all
set services firewall filter OUT_TRUSTED rule 10 actions
set services firewall filter OUT_TRUSTED rule 10 actions action accept
set services firewall filter OUT_UNTRUSTED rule 1 match src-address
set services firewall filter OUT_UNTRUSTED rule 1 match src-address address-set CELL-IP
set services firewall filter OUT_UNTRUSTED rule 1 match src-address add-interface-address true
set services firewall filter OUT_UNTRUSTED rule 1 actions
set services firewall filter OUT_UNTRUSTED rule 1 actions action accept
set services firewall filter OUT_UNTRUSTED rule 2 match protocol all
set services firewall filter OUT_UNTRUSTED rule 2 actions
set services firewall filter OUT_UNTRUSTED rule 2 actions action drop
```

### 12.2.1.2 Status

#### # IKE/IPsec status

> **show services vpn**

```
services vpn ike security-associations security-association 5
```



```

name          DMVPN
state         ESTABLISHED
local-host    172.18.175.138
local-id      "C=US, ST=NY, L=Rochester, O=GE MDS, OU=ENGG, CN=VZW138.com"
remote-host   172.18.175.45
remote-id     "CN=DMVPN-HUB.com, OU=ENGG, O=GE MDS, L=Rochester, ST=NY, C=US,
unstructuredName=DMVPN-HUB.com"
initiator     true
initiator-spi ba596984ff972043
responder-spi 0c2e769cbc243bf3
ciphersuite   AES_CBC-256/HMAC_SHA1_96/PRF_HMAC_SHA1/MODP_1536
established-time 574
rekey-time    9200
reauth-time   2075232

```

```
services vpn ipsec security-associations security-association 4
```

```

name          DMVPN
state         INSTALLED
mode          TRANSPORT
udp-encap    false
in-spi       c0b5d5d0
out-spi      26c5d2f3
ciphersuite  AES_CBC-256/HMAC_SHA1_96
in-bytes     34106
in-packets   492
in-last-use  1
out-bytes    9094
out-packets  140
out-last-use 2
rekey-time   2195
life-time    3026
install-time 575
local-ts     172.18.175.138/32[gre]
remote-ts    172.18.175.45/32[gre]

```

**# NHRP status**

**> show services nhrp**

EXPIRES

| NBMA ADDRESS | PROTOCOL ADDRESS | STATE | TYPE | IN |
|--------------|------------------|-------|------|----|
|--------------|------------------|-------|------|----|

|         |                  |    |       |  |
|---------|------------------|----|-------|--|
| 0.0.0.0 | 192.168.1.255/32 | up | local |  |
| 0.0.0.0 | 192.168.1.11/32  | up | local |  |



```
0.0.0.0    192.168.1.0/32 up    local
0.0.0.0    192.168.1.0/24 up    local
0.0.0.0    172.16.0.3/32 up    local
172.18.175.45 172.16.0.1/24 used up static
```

### # Routing status

# The highlighted default route is received from the IOS router via BGP.

> show routing-state routes

```
                OUTGOING
DEST PREFIX    NEXT HOP  INTERFACE  SOURCE
-----
0.0.0.0/0      172.16.0.1 GRE1        dynamic
10.0.3.0/24    -        Bridge     kernel
172.16.0.0/24  -        GRE1       kernel
172.18.175.0/24 -        Cell       static
```

> show routing-state bgp

```
routing-state bgp neighbor PRIMARY-HUB
routing-instance inet.main
state          up
preference     100
import-filter  ACCEPT
export-filter  LOCAL-LAN
statistics import-updates-received 1
statistics import-updates-rejected 0
statistics import-updates-filtered 0
statistics import-updates-ignored 0
statistics import-updates-accepted 1
statistics import-withdraws-received 0
statistics import-withdraws-rejected 0
statistics import-withdraws-ignored 0
statistics import-withdraws-accepted 0
statistics export-updates-received 8
statistics export-updates-rejected 1
statistics export-updates-filtered 6
statistics export-updates-accepted 1
statistics export-withdraws-received 0
statistics export-withdraws-accepted 0
local-state    established
peer-address    172.16.0.1
```



```
peer-as      65500
peer-id      172.16.0.1
local-address 172.16.0.3
hold-time    18/30
keepalive-time 9/10
```

## 12.2.2 Cisco IOS

### 12.2.2.1 Configuration

#### # NTP configuration

```
ntp server 172.18.175.62
!
```

#### # Local LAN network interface configuration

```
interface GigabitEthernet0/1
ip address 10.0.1.0 255.255.255.0
duplex auto
speed auto
!
```

#### # WAN network interface configuration

```
interface GigabitEthernet0/0
# Ensure that the MTU configured matches the cell interface MTU (default=1428).
mtu 1428
ip address 172.18.175.45 255.255.255.0
duplex auto
speed auto
!
```

#### # Certificate configuration

```
crypto pki trustpoint DMVPN-3-TIER-SUBCA-2
enrollment terminal pem
subject-name C=US, ST=NY, L=Rochester, O=GE MDS, OU=ENGG, CN=DMVPN-HUB.com
revocation-check none
rsa-keypair DMVPN-3-TIER-SUBCA-2 2048
!
```

**# Below assumes that Orbit client certificates have 'orbit' string in the common name. This enables this certificate map to be used for all Orbits that connect to this router.**

```
crypto pki certificate map ORBIT_CERT_MAP 1
subject-name co cn = orbit
!
```





**# NOTE: Only client certificate and SUB CA-2 certificate needs to be installed.**

```
crypto pki certificate chain DMVPN-3-TIER-SUBCA-2
```

```
certificate 0B
```

```
<CONTENTS REMOVED FOR BREVITY>
```

```
quit
```

```
certificate ca 02
```

```
<CONTENTS REMOVED FOR BREVITY>
```

```
quit
```

### **# IKE/IPsec configuration**

```
crypto ikev2 proposal DMVPN_IKEV2_PROPOSAL
```

```
encryption aes-cbc-256
```

```
integrity sha1
```

```
group 5
```

```
!
```

```
crypto ikev2 policy DMVPN_IKEV2_POLICY
```

```
match fvrf any
```

```
proposal DMVPN_IKEV2_PROPOSAL
```

```
!
```

```
crypto ikev2 profile DMVPN_IKEV2_PROFILE
```

```
match certificate ORBIT_CERT_MAP
```

```
identity local dn
```

```
authentication remote rsa-sig
```

```
authentication local rsa-sig
```

```
pki trustpoint DMVPN-3-TIER-SUBCA-2
```

```
dpd 10 3 periodic
```

```
!
```

```
crypto ipsec transform-set DMVPN_TRANSFORM esp-aes 256 esp-sha-hmac
```

```
mode transport
```

```
!
```

```
crypto ipsec profile DMVPN
```

```
set transform-set DMVPN_TRANSFORM
```

```
set ikev2-profile DMVPN_IKEV2_PROFILE
```

```
!
```

### **# Multipoint GRE tunnel configuration**

```
interface Tunnel0
```

```
description DMVPN NETWORK
```

```
ip address 172.16.0.1 255.255.255.0
```

```
no ip redirects
```



**#Ensure that MTU matches one configured on the GRE interface on Orbit.**

```
ip mtu 1346
ip nhrp authentication cisco123
ip nhrp map multicast dynamic
ip nhrp network-id 99
ip nhrp holdtime 300
ip nhrp shortcut
ip nhrp redirect
no ip split-horizon
ip tcp adjust-mss 1300
tunnel source GigabitEthernet0/0
tunnel mode gre multipoint
tunnel key 10000
tunnel protection ipsec profile DMVPN
!
```

**# BGP routing configuration**

```
router bgp 65500
bgp router-id 172.16.0.1
bgp log-neighbor-changes
bgp listen range 172.16.0.0/24 peer-group DMVPN-SPOKE
neighbor DMVPN-SPOKE peer-group
neighbor DMVPN-SPOKE remote-as 65550
neighbor DMVPN-SPOKE next-hop-self
neighbor DMVPN-SPOKE default-originate
!
ip route 0.0.0.0 0.0.0.0 172.18.175.62
!
```

### 12.2.2.2 Status

**#IKE/IPsec status**

**DMVPN-HUB#show crypto ikev2 sa**

IPv4 Crypto IKEv2 SA

Tunnel-id	Local	Remote	fvr/ivrf	Status
1	172.18.175.45/4500	172.18.175.138/4500	none/none	READY
Encr: AES-CBC, keysize: 256, Hash: SHA96, DH Grp:5, Auth sign: RSA, Auth verify: RSA				
Life/Active Time: 86400/1714 sec				

IPv6 Crypto IKEv2 SA

**DMVPN-HUB#show crypto ipsec sa**



interface: Tunnel0

Crypto map tag: Tunnel0-head-0, local addr 172.18.175.45

protected vrf: (none)

local ident (addr/mask/prot/port): (172.18.175.45/255.255.255.255/47/0)

remote ident (addr/mask/prot/port): (172.18.175.138/255.255.255.255/47/0)

current\_peer 172.18.175.138 port 4500

PERMIT, flags={origin\_is\_acl,}

#pkts encaps: 32660, #pkts encrypt: 32660, #pkts digest: 32660

#pkts decaps: 13845, #pkts decrypt: 13845, #pkts verify: 13845

#pkts compressed: 0, #pkts decompressed: 0

#pkts not compressed: 0, #pkts compr. failed: 0

#pkts not decompressed: 0, #pkts decompress failed: 0

#send errors 0, #rcv errors 0

local crypto endpt.: 172.18.175.45, remote crypto endpt.: 172.18.175.138

path mtu 1500, ip mtu 1500, ip mtu idb (none)

current outbound spi: 0xCF3F2463(3477021795)

PFS (Y/N): N, DH group: none

inbound esp sas:

spi: 0x1BB50496(464848022)

transform: esp-256-aes esp-sha-hmac ,

in use settings ={Transport, }

conn id: 2681, flow\_id: Onboard VPN:681, sibling\_flags 80000000, crypto map: Tunnel0-head-0

sa timing: remaining key lifetime (k/sec): (4255357/2041)

IV size: 16 bytes

replay detection support: N

Status: ACTIVE(ACTIVE)

inbound ah sas:

inbound pcp sas:

outbound esp sas:

spi: 0xCF3F2463(3477021795)

transform: esp-256-aes esp-sha-hmac ,

in use settings ={Transport, }

conn id: 2682, flow\_id: Onboard VPN:682, sibling\_flags 80000000, crypto map: Tunnel0-head-0



sa timing: remaining key lifetime (k/sec): (4255276/2041)  
 IV size: 16 bytes  
 replay detection support: N  
 Status: ACTIVE(ACTIVE)

outbound ah sas:

outbound pcp sas:

**# NHRP status**

**DMVPN-HUB#show dmvpn**

Legend: Attrb --> S - Static, D - Dynamic, I - Incomplete  
 N - NATed, L - Local, X - No Socket  
 # Ent --> Number of NHRP entries with same NBMA peer  
 NHS Status: E --> Expecting Replies, R --> Responding, W --> Waiting  
 UpDn Time --> Up or Down Time for a Tunnel

=====

Interface: Tunnel0, IPv4 NHRP Details  
 Type:Hub, NHRP Peers:1,

# Ent	Peer NBMA Addr	Peer Tunnel Add	State	UpDn Tm	Attrb
1	172.18.175.138	172.16.0.3	UP	16:55:28	D

**# Routing status**

**# The highlighted route is the LAN network route received from Orbit via BGP.**

**DMVPN-HUB#show ip route**

Codes: L - local, C - connected, S - static, R - RIP, M - mobile, B - BGP  
 D - EIGRP, EX - EIGRP external, O - OSPF, IA - OSPF inter area  
 N1 - OSPF NSSA external type 1, N2 - OSPF NSSA external type 2  
 E1 - OSPF external type 1, E2 - OSPF external type 2  
 i - IS-IS, su - IS-IS summary, L1 - IS-IS level-1, L2 - IS-IS level-2  
 ia - IS-IS inter area, \* - candidate default, U - per-user static route  
 o - ODR, P - periodic downloaded static route, H - NHRP, I - LISP  
 + - replicated route, % - next hop override

Gateway of last resort is 172.18.175.62 to network 0.0.0.0

S\* 0.0.0.0/0 [1/0] via 172.18.175.62  
 10.0.1.0/24 is variably subnetted, 2 subnets, 2 masks



- C 10.0.1.0/24 is directly connected, GigabitEthernet0/1
- L 10.0.1.1/32 is directly connected, GigabitEthernet0/1
- 172.16.0.0/16 is variably subnetted, 2 subnets, 2 masks
- C 172.16.0.0/24 is directly connected, Tunnel0
- L 172.16.0.1/32 is directly connected, Tunnel0
- 172.18.0.0/16 is variably subnetted, 2 subnets, 2 masks
- C 172.18.175.0/24 is directly connected, GigabitEthernet0/0
- L 172.18.175.45/32 is directly connected, GigabitEthernet0/0
- 192.168.1.0/24 is variably subnetted, 2 subnets, 2 masks
- B 192.168.1.0/24 [20/0] via 172.16.0.3, 16:54:41

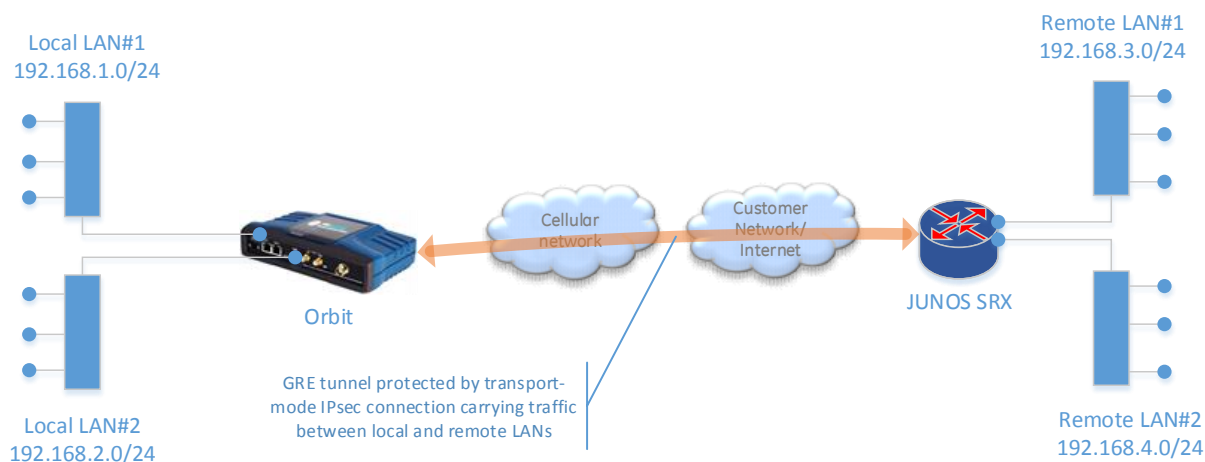
## 12.3 GRE/IPsec with Juniper JUNOS

In this example, we describe a sample configuration for a GRE/IPsec between Orbit MCR (2E1S) and Juniepr SRX240 with IKEv2 pre-shared key authentication.

---

**NOTE** The Juniper JUNOS based devices do not support IPsec transport mode for data traffic. Therefore, to protect GRE traffic one needs to setup IPsec tunnel instead of IPsec transport mode connection. This leads to double tunneling- GRE tunnel within IPsec tunnel. Also, GRE tunneling over IPsec tunnel is only supported for route-based tunnel setup.

---



### 12.3.1 Orbit

#### 12.3.1.1 Configuration

##### # Bridge/LAN#1 interface configuration

```
set interfaces interface Bridge type bridge
set interfaces interface Bridge ipv4 address 192.168.1.1 prefix-length 24
set interfaces interface Bridge filter input IN_TRUSTED
set interfaces interface Bridge filter output OUT_TRUSTED
set interfaces interface Bridge bridge-settings members port ETH1
```



### **# Bridge/LAN#2 interface configuration**

```
set interfaces interface Bridge2 type bridge
set interfaces interface Bridge2 ipv4 address 192.168.2.1 prefix-length 24
set interfaces interface Bridge2 filter input IN_TRUSTED
set interfaces interface Bridge2 filter output OUT_TRUSTED
set interfaces interface Bridge2 bridge-settings members port ETH1
```

### **# Cell interface configuration**

```
set interfaces interface Cell type cellular
set interfaces interface Cell enabled true
set interfaces interface Cell ipv4 dhcp point-to-point-connection true
set interfaces interface Cell filter input IN_UNTRUSTED
set interfaces interface Cell filter output OUT_UNTRUSTED
set interfaces interface Cell cell-config connection-profile PROFILE-1 bearer-config apn <CUSTOMER-APN>
```

### **# Loopback interface used as source address for GRE tunnels towards JUNOS**

#### **# This is required for GRE traffic to ride on IPsec tunnel**

```
set interfaces interface LO-SRX240 type loopback
set interfaces interface LO-SRX240 ipv4 address 172.16.1.2 prefix-length 32
```

### **# IKE/IPsec configuration**

```
set services vpn enabled true
set services vpn ike policy SRX240-IKE-POLICY auth-method pre-shared-key
set services vpn ike policy SRX240-IKE-POLICY pre-shared-key test123
set services vpn ike policy SRX240-IKE-POLICY ciphersuite CS1 encryption-algo aes128-cbc
set services vpn ike policy SRX240-IKE-POLICY ciphersuite CS1 mac-algo sha256-hmac
set services vpn ike policy SRX240-IKE-POLICY ciphersuite CS1 dh-group dh14
set services vpn ike peer SRX240-IKE-PEER ike-policy SRX240-IKE-POLICY
set services vpn ike peer SRX240-IKE-PEER local-identity default
set services vpn ike peer SRX240-IKE-PEER peer-endpoint address 172.18.1.75.40
set services vpn ike peer SRX240-IKE-PEER peer-identity default
set services vpn ike peer SRX240-IKE-PEER role initiator
set services vpn ipsec policy SRX240-IPSEC-POLICY ciphersuite CS1 encryption-algo aes128-cbc
set services vpn ipsec policy SRX240-IPSEC-POLICY ciphersuite CS1 mac-algo sha256-hmac
set services vpn ipsec policy SRX240-IPSEC-POLICY ciphersuite CS1 dh-group dh14
set services vpn ipsec connection SRX240 ike-peer SRX240-IKE-PEER
set services vpn ipsec connection SRX240 ipsec-policy SRX240-IPSEC-POLICY
set services vpn ipsec connection SRX240 local-ip-subnet 172.16.1.2/32
set services vpn ipsec connection SRX240 remote-ip-subnets 172.16.1.1/32
set services vpn ipsec connection SRX240 filter input IN_TRUSTED
```



```
set services vpn ipsec connection SRX240 filter output OUT_TRUSTED
```

#### **# GRE interface configuration**

```
set interfaces interface GRE-SRX240 type gre
set interfaces interface GRE-SRX240 gre-config mode ip-over-gre
set interfaces interface GRE-SRX240 gre-config src-address 172.16.1.2
set interfaces interface GRE-SRX240 gre-config dst-address 172.16.1.1
set interfaces interface GRE-SRX240 ipv4 mtu 1250
set interfaces interface GRE-SRX240 ipv4 address 10.1.1.2 prefix-length 30
set interfaces interface GRE-SRX240 filter input IN_TRUSTED
set interfaces interface GRE-SRX240 filter output OUT_TRUSTED
```

#### **# Routing configuration**

```
set routing static-routes ipv4 route 1 dest-prefix 192.168.3.0/24
set routing static-routes ipv4 route 1 outgoing-interface GRE-SRX240
set routing static-routes ipv4 route 1 dest-prefix 192.168.4.0/24
set routing static-routes ipv4 route 1 outgoing-interface GRE-SRX240
```

#### **# Firewall configuration**

```
set services firewall enabled true
set services firewall address-set CELL-IP
set services firewall filter IN_TRUSTED rule 10 match protocol all
set services firewall filter IN_TRUSTED rule 10 actions
set services firewall filter IN_TRUSTED rule 10 actions action accept
set services firewall filter IN_UNTRUSTED rule 1 match protocol icmp
set services firewall filter IN_UNTRUSTED rule 1 actions
set services firewall filter IN_UNTRUSTED rule 1 actions action accept
set services firewall filter IN_UNTRUSTED rule 2 match protocol udp
set services firewall filter IN_UNTRUSTED rule 2 match src-port
set services firewall filter IN_UNTRUSTED rule 2 match src-port services [ dns ]
set services firewall filter IN_UNTRUSTED rule 10 match protocol udp
set services firewall filter IN_UNTRUSTED rule 10 match dst-port
set services firewall filter IN_UNTRUSTED rule 10 match dst-port services [ ike ntp ]
set services firewall filter IN_UNTRUSTED rule 10 actions
set services firewall filter IN_UNTRUSTED rule 10 actions action accept
set services firewall filter IN_UNTRUSTED rule 11 match protocol esp
set services firewall filter IN_UNTRUSTED rule 11 actions
set services firewall filter IN_UNTRUSTED rule 11 actions action accept
set services firewall filter IN_UNTRUSTED rule 12 match protocol all
set services firewall filter IN_UNTRUSTED rule 12 actions
```



```
set services firewall filter IN_UNTRUSTED rule 12 actions action drop
set services firewall filter OUT_TRUSTED rule 10 match protocol all
set services firewall filter OUT_TRUSTED rule 10 actions
set services firewall filter OUT_TRUSTED rule 10 actions action accept
set services firewall filter OUT_UNTRUSTED rule 1 match src-address
set services firewall filter OUT_UNTRUSTED rule 1 match src-address address-set CELL-IP
set services firewall filter OUT_UNTRUSTED rule 1 match src-address add-interface-address true
set services firewall filter OUT_UNTRUSTED rule 1 actions
set services firewall filter OUT_UNTRUSTED rule 1 actions action accept
set services firewall filter OUT_UNTRUSTED rule 2 match protocol all
set services firewall filter OUT_UNTRUSTED rule 2 actions
set services firewall filter OUT_UNTRUSTED rule 2 actions action drop
```

### 12.3.1.2 Status

#### #IKE/IPsec status

##### > show services vpn

```
services vpn ike security-associations security-association 54
name          SRX240_SA
state         ESTABLISHED
local-host    172.18.175.135
local-id      172.18.175.135
remote-host   172.18.175.40
remote-id     172.18.175.40
initiator     true
initiator-spi 78c786f79094ac55
responder-spi c5aa90f242499e8d
ciphersuite   AES_CBC-128/HMAC_SHA2_256_128/PRF_HMAC_SHA2_256/MODP_2048
established-time 694
rekey-time    9143
reauth-time   1852140901
services vpn ipsec security-associations security-association 196
name          SRX240_SA
state         INSTALLED
mode          TUNNEL
udp-encap     false
in-spi        cce4cde5
out-spi       4c84f08c
ciphersuite   AES_CBC-128/HMAC_SHA2_256_128/MODP_2048
in-bytes      0
in-packets    0
in-last-use   1621200
```





```
out-bytes 0
out-packets 0
out-last-use 0
rekey-time 708
life-time 1590
install-time 2010
local-ts 172.16.1.2/32
remote-ts 172.16.1.1/32
```

## # Routing status

> show routing-state routes

```
                OUTGOING
DEST PREFIX    NEXT HOP    INTERFACE    SOURCE
-----
0.0.0.0/0      -          Cell         kernel
10.1.1.0/30    -          GRE-SRX240   kernel
192.168.1.0/24 -          Bridge       kernel
192.168.2.0/24 -          Bridge2      kernel
172.16.1.1/32  172.18.175.40 Cell         static
```

## 12.3.2 JUNOS

### 12.3.2.1 Configuration

#### # WAN external interface

# NOTE: Ensure that MTU value matches that configured on Cell interface on Orbit (default=1428).

```
set interfaces ge-0/0/0 unit 0 family inet mtu 1428
set interfaces ge-0/0/0 unit 0 family inet address 172.18.175.40/26
```

#### # Local LAN#1 interface

```
set interfaces vlan unit 0 family inet address 192.168.3.1/24
set interfaces ge-0/0/1 unit 0 family ethernet-switching vlan members vlan-trust-1
set vlans vlan-trust-1 vlan-id 1
set vlans vlan-trust I3-interface vlan.0
```

#### # Local LAN#2 interface

```
set interfaces vlan unit 1 family inet address 192.168.4.1/24
set interfaces ge-0/0/2 unit 0 family ethernet-switching vlan members vlan-trust-2
set vlans vlan-trust-2 vlan-id 2
set vlans vlan-trust I3-interface vlan.1
```

#### # Loopback interface used as source address for GRE tunnels towards Orbits



```
set interfaces lo0 unit 0 family inet address 172.16.1.1/32
```

#### # Qos Traffic shaping (optional)

```
set interfaces gr-0/0/0 per-unit-scheduler
```

```
set chassis fpc 0 pic 0 tunnel-queuing
```

#### # Common routing

```
set routing-options static route 0.0.0.0/0 next-hop 172.18.175.62
```

#### # Common IKE

```
set security ike proposal IKE-PROP-PSK authentication-method pre-shared-keys
```

```
set security ike proposal IKE-PROP-PSK dh-group group14
```

```
set security ike proposal IKE-PROP-PSK authentication-algorithm sha-256
```

```
set security ike proposal IKE-PROP-PSK encryption-algorithm aes-128-cbc
```

```
set security ike policy IKE-POLICY-PSK proposals IKE-PROP-PSK
```

```
set security ike policy IKE-POLICY-PSK pre-shared-key ascii-text test123
```

#### # Common IPsec

```
set security ipsec proposal IPSEC-PROP protocol esp
```

```
set security ipsec proposal IPSEC-PROP authentication-algorithm hmac-sha-256-128
```

```
set security ipsec proposal IPSEC-PROP encryption-algorithm aes-128-cbc
```

```
set security ipsec policy IPSEC-POLICY perfect-forward-secrecy keys group14
```

```
set security ipsec policy IPSEC-POLICY proposals IPSEC-PROP
```

#### # Common Policies

```
set security policies from-zone TRUST to-zone TRUST policy TTT match source-address any
```

```
set security policies from-zone TRUST to-zone TRUST policy TTT match destination-address any
```

```
set security policies from-zone TRUST to-zone TRUST policy TTT match application any
```

```
set security policies from-zone TRUST to-zone TRUST policy TTT then permit
```

#### # Common zones

```
set security zones security-zone TRUST address-book address LOCAL-NET-1 172.16.1.1/32
```

```
set security zones security-zone TRUST host-inbound-traffic system-services all
```

```
set security zones security-zone TRUST interfaces vlan.0
```

```
set security zones security-zone TRUST interfaces vlan.1
```

```
set security zones security-zone TRUST interfaces lo0.0
```

```
set security zones security-zone UNTRUST host-inbound-traffic system-services ike
```

```
set security zones security-zone UNTRUST host-inbound-traffic system-services ping
```

```
set security zones security-zone UNTRUST host-inbound-traffic system-services ntp
```

```
set security zones security-zone UNTRUST interfaces ge-0/0/0.0
```



### **# Config for ORBIT135**

#### **# IPsec tunnel interface**

set interfaces st0 unit 0 family inet address 10.11.11.1/30

#### **# GRE tunnel interface**

set interfaces gr-0/0/0 unit 0 tunnel source 172.16.1.1

set interfaces gr-0/0/0 unit 0 tunnel destination 172.16.1.2

set interfaces gr-0/0/0 unit 0 family inet mtu 1250

set interfaces gr-0/0/0 unit 0 family inet address 10.1.1.1/30

#### **# Rate limiting applied to GRE tunnel interface (optional)**

set class-of-service interfaces gr-0/0/0 unit 0 shaping-rate 1m

#### **# IKE**

set security ike gateway ORBIT135 ike-policy IKE-POLICY-PSK

set security ike gateway ORBIT135 address 172.18.175.135

set security ike gateway ORBIT135 local-identity inet 172.18.175.40

set security ike gateway ORBIT135 external-interface ge-0/0/0

set security ike gateway ORBIT135 version v2-only

#### **# IPsec**

set security ipsec vpn ORBIT135 bind-interface st0.0

set security ipsec vpn ORBIT135 ike gateway ORBIT135

set security ipsec vpn ORBIT135 ike ipsec-policy IPSEC-POLICY

#### **# IPsec policies**

set security policies from-zone TRUST to-zone VPN-ORBIT135 policy ORBIT135 match source-address LOCAL-NET-1

set security policies from-zone TRUST to-zone VPN-ORBIT135 policy ORBIT135 match destination-address ORBIT135-NET-1

set security policies from-zone TRUST to-zone VPN-ORBIT135 policy ORBIT135 match application any

set security policies from-zone TRUST to-zone VPN-ORBIT135 policy ORBIT135 then permit

set security policies from-zone VPN-ORBIT135 to-zone TRUST policy ORBIT135 match source-address ORBIT135-NET-1

set security policies from-zone VPN-ORBIT135 to-zone TRUST policy ORBIT135 match destination-address LOCAL-NET-1

set security policies from-zone VPN-ORBIT135 to-zone TRUST policy ORBIT135 match application any

set security policies from-zone VPN-ORBIT135 to-zone TRUST policy ORBIT135 then permit

set security zones security-zone VPN-ORBIT135 address-book address ORBIT135-NET-1 176.16.1.2/32

set security zones security-zone VPN-ORBIT135 interfaces st0.0



```
set security zones security-zone TRUST interfaces gr-0/0/0.0
```

### # Routes to Orbit LAN networks

```
set routing-options static route 172.16.1.2/32 next-hop st0.0
set routing-options static route 192.168.1.0/24 next-hop gr-0/0/0.0
set routing-options static route 192.168.2.0/24 next-hop gr-0/0/0.0
```

## 12.3.2.2 Status

### # IKE/IPsec status

#### > show security ike security-associations

Index	State	Initiator cookie	Responder cookie	Mode	Remote Address
1948872	UP	55ac9490f786c778	8d9e4942f290aac5	IKEv2	172.18.175.135

#### > show security ipsec security-associations

Total active tunnels: 1

ID	Algorithm	SPI	Life:sec/kb	Mon vsys	Port	Gateway
<131073	ESP:aes-128/sha256	5e4fca36	3403/	unlim	- root 500	172.18.175.135
>131073	ESP:aes-128/sha256	cb6ed905	3403/	unlim	- root 500	172.18.175.135

### # Routing status

#### > show route

```
0.0.0.0/0      *[Static/5] 1w5d 18:34:56
                > to 172.18.175.62 via ge-0/0/0.0
10.1.1.0/30    *[Direct/0] 1w5d 18:35:02
                > via gr-0/0/0.0
10.1.1.1/32    *[Local/0] 1w5d 18:35:02
                Local via gr-0/0/0.0
10.11.11.0/30  *[Direct/0] 1w5d 20:14:32
                > via st0.0
10.11.11.1/32  *[Local/0] 1w5d 20:14:32
                Local via st0.0
172.16.1.1/32  *[Direct/0] 1w5d 20:14:55
                > via lo0.0
172.16.1.2/32  *[Static/5] 1w2d 20:03:32
                > via st0.0
172.18.175.0/26 *[Direct/0] 1w5d 18:34:56
                > via ge-0/0/0.0
172.18.175.40/32 *[Local/0] 1w5d 18:35:03
                Local via ge-0/0/0.0
192.168.3.0/24 *[Direct/0] 1w5d 18:34:56
```



```
> via vlan.0
192.168.3.1/32  *[Local/0] 1w5d 20:14:32
    Local via vlan.0
192.168.4.0/24  *[Direct/0] 1w5d 18:34:56
    > via vlan.1
192.168.4.1/32  *[Local/0] 1w5d 20:14:32
    Local via vlan.1
192.168.1.0/24  *[Static/5] 1w5d 18:35:02
    > via gr-0/0/0.0
192.168.2.0/24  *[Static/5] 1w5d 18:35:02
    > via gr-0/0/0.0
```

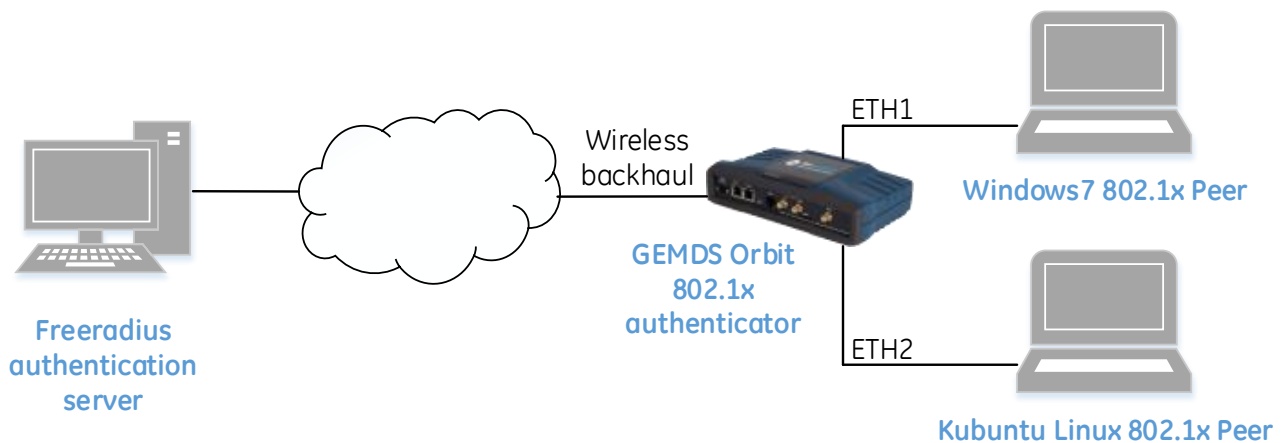


## 13.0 APPENDIX H – 802.1x Port Authentication w/ EAP

### 13.1 Overview

The Orbit can act as an 802.1x port authenticator for its ETH1 and ETH2 interfaces. The following diagram depicts the Orbit 802.1x port authentication setup used throughout this document. Either EAP or MAB mode can be configured for ETH1 and ETH2. This document shows how to configure each component in the diagram for EAP authentication mode.

The Orbit blocks all traffic (except EAP frames) on the Ethernet port until it can authenticate the peer connected to that port. The Orbit must be able to communicate with the RADIUS authentication server through a non-authenticating Ethernet port or other backhaul network interface like the cellular modem.



### 13.2 Configuration Examples

#### 13.2.1 Orbit Device

The following shows an example of port authentication configuration on the Orbit, using EAP mode on ETH1 and ETH2.

```
set system mds-radius servers ghost address 192.168.1.2
set system mds-radius servers ghost shared-secret password

set interfaces interface ETH1 security security-mode EAP
set interfaces interface ETH1 security radius-server ghost

set interfaces interface ETH2 security security-mode EAP
set interfaces interface ETH2 security radius-server ghost
```



The status of port authentication for all network interfaces on the Orbit can be viewed by issuing the following command. Although all interfaces are displayed, port authentication only applies to ETH1 and ETH2.

```
run show interfaces-state interface security
NAME SECURITY
-----
Bridge -
Cell -
ETH1 pending
ETH2 authorized
NxRadio -
```

### 13.2.2 Freeradius

Setup freeradius with server and device certificates, users, and network clients. The following shows only a snippet of the configuration but has the most important sections listed.

#### **/etc/freeradius/users**

```
# Username/password example
joe Cleartext-Password := password

# MAC Authentication Bypass (MAB) examples
d89d67f4ffb6 Cleartext-Password := d89d67f4ffb6
0010186f8dfd Cleartext-Password := 0010186f8dfd
989096cbcd6e Cleartext-Password := 989096cbcd6e
00133b109b4c Cleartext-Password := 00133b109b4c
```

#### **/etc/freeradius/eap.conf**

Setup tls { } section with your certificates, key and key password

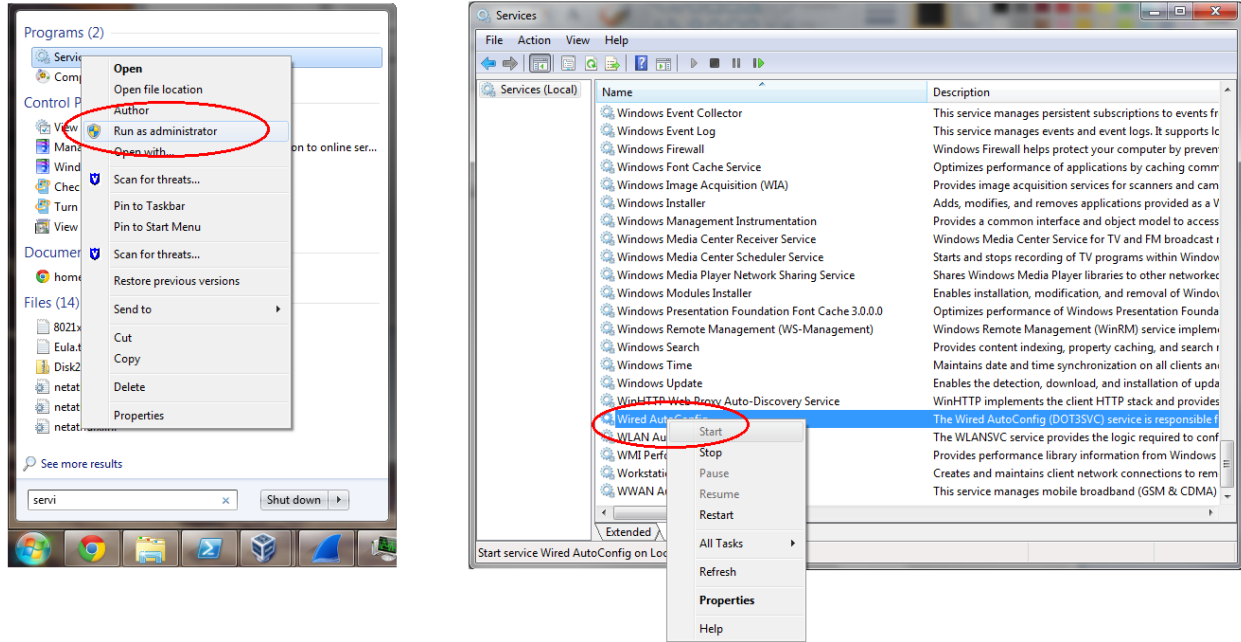
#### **/etc/freeradius/clients.conf**

```
# Allow connections from devices in this network
client 192.168.1.0/24 {
    secret = password
    shortname = ghost
}
```



### 13.2.3 Windows as 802.1x peer/supplicant – start WiredAutoConfig service

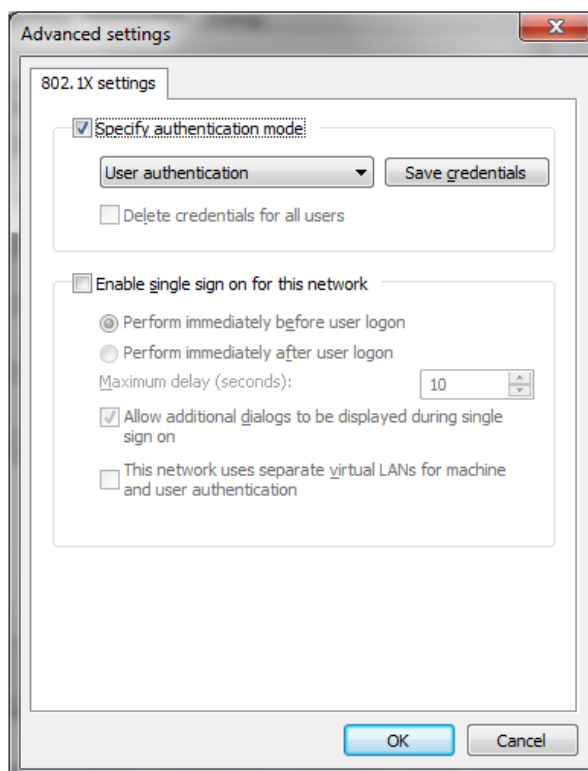
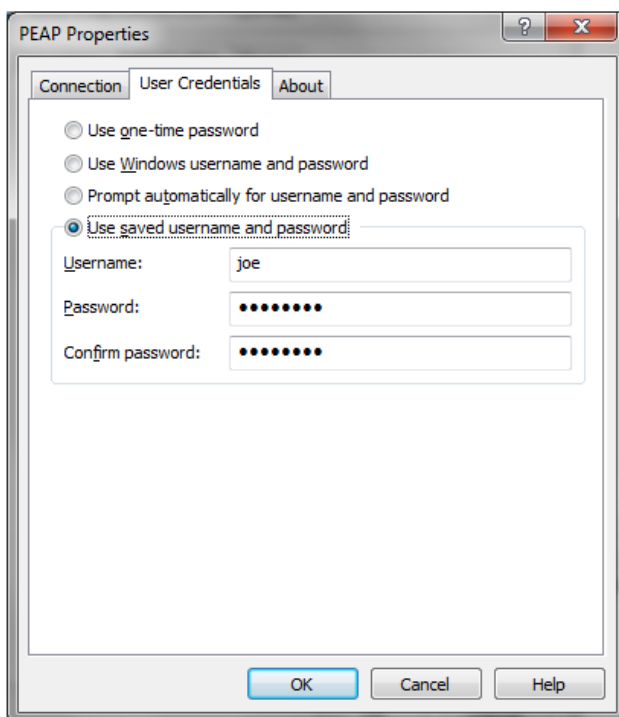
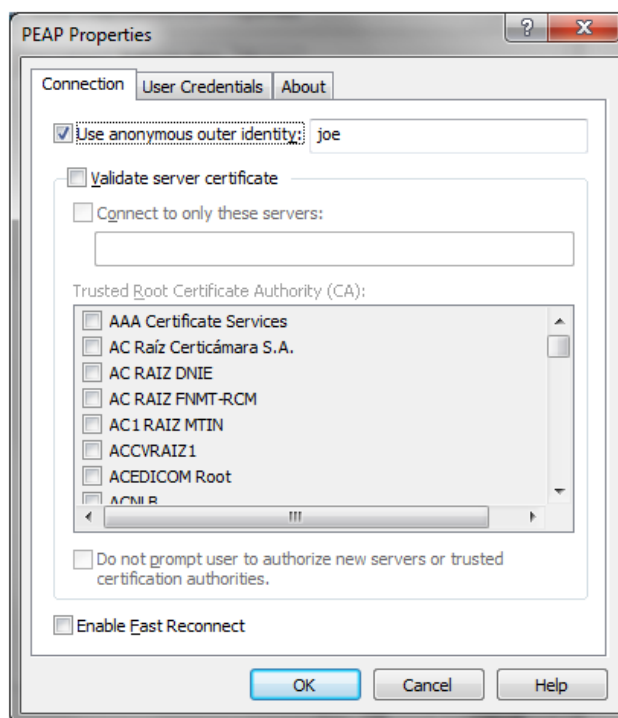
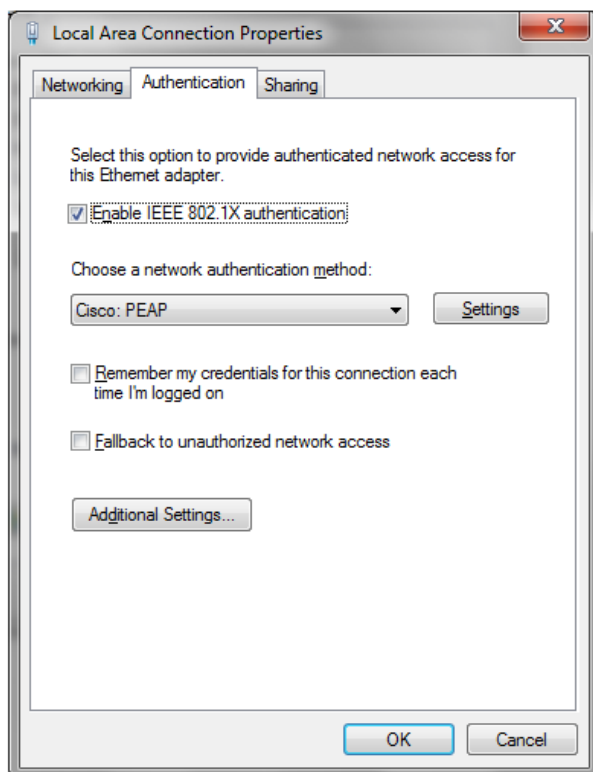
All EAP authentication modes on Windows require the following service to be started before configuring authentication on a wired network interface. When using EAP, the Orbit ETH port security mode must also be set to EAP. The Orbit is agnostic to the specific EAP method chosen. Examples in this document show Cisco PEAP and EAP-TLS methods being used.



### 13.2.4 Windows configuration #1 - Cisco PEAP mode

Following shows the configuration used to test Cisco PEAP mode on Windows

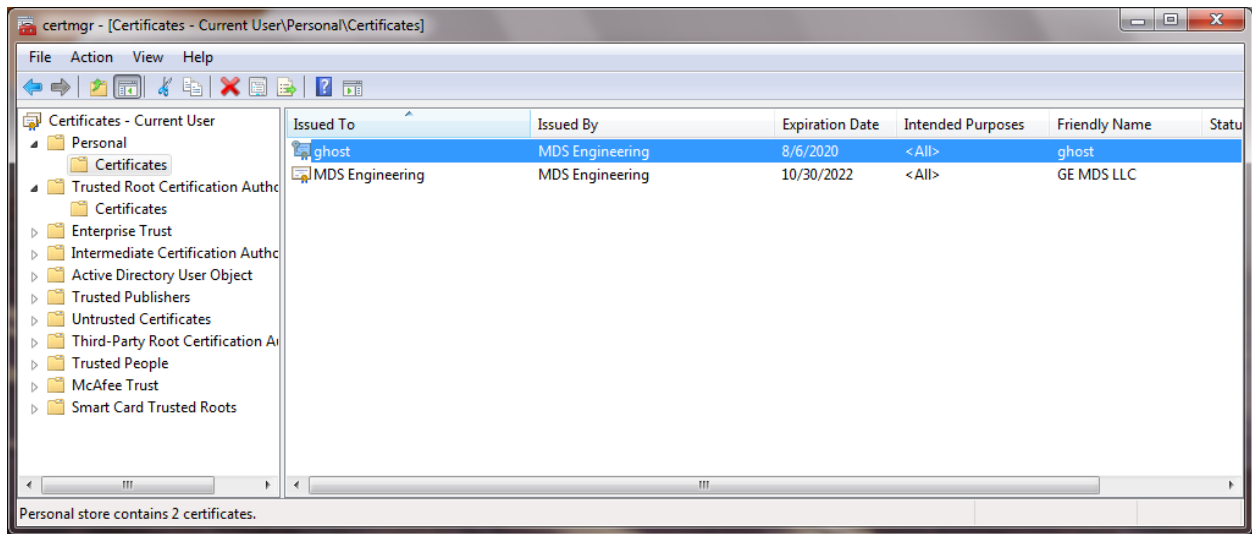




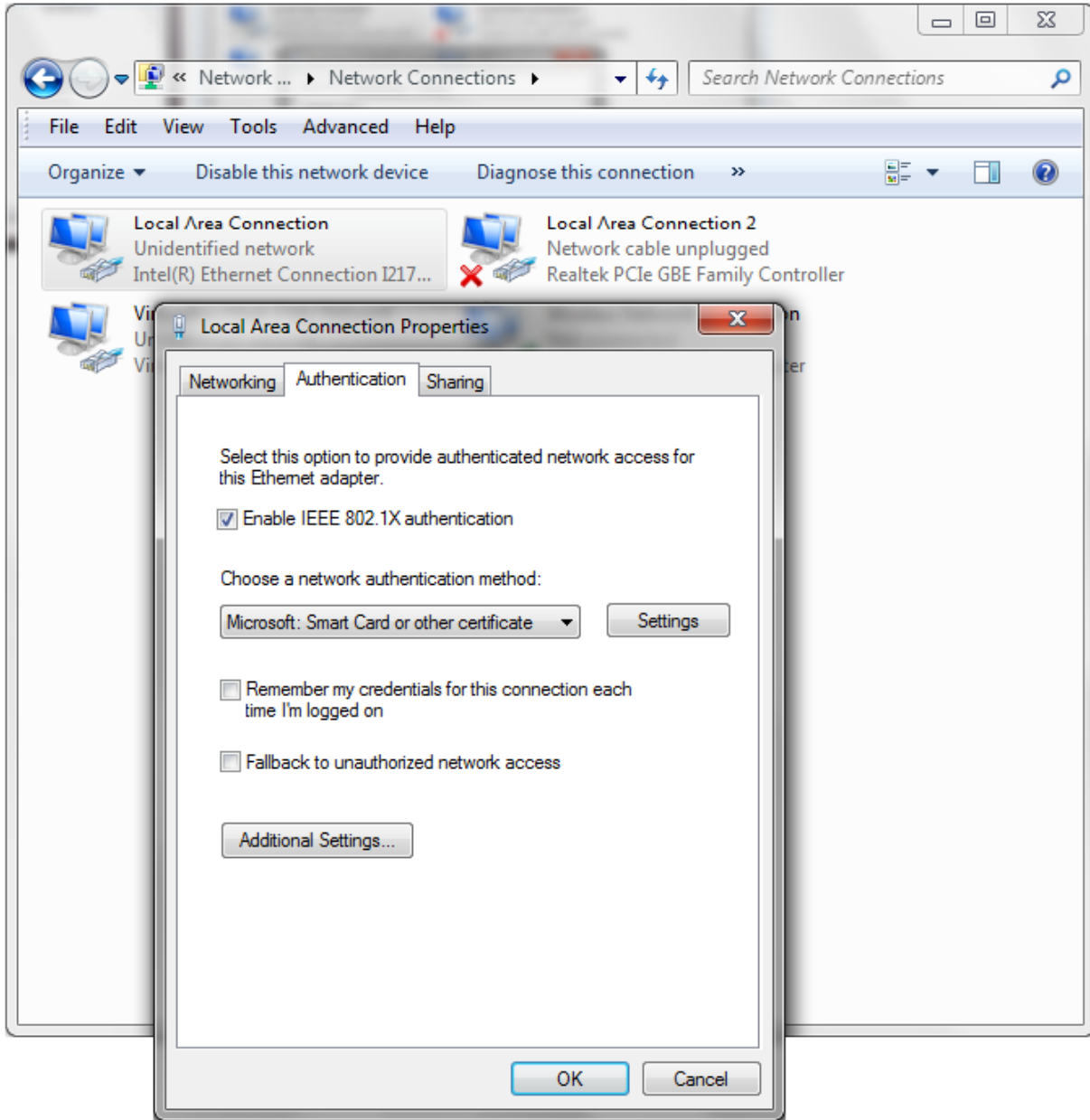


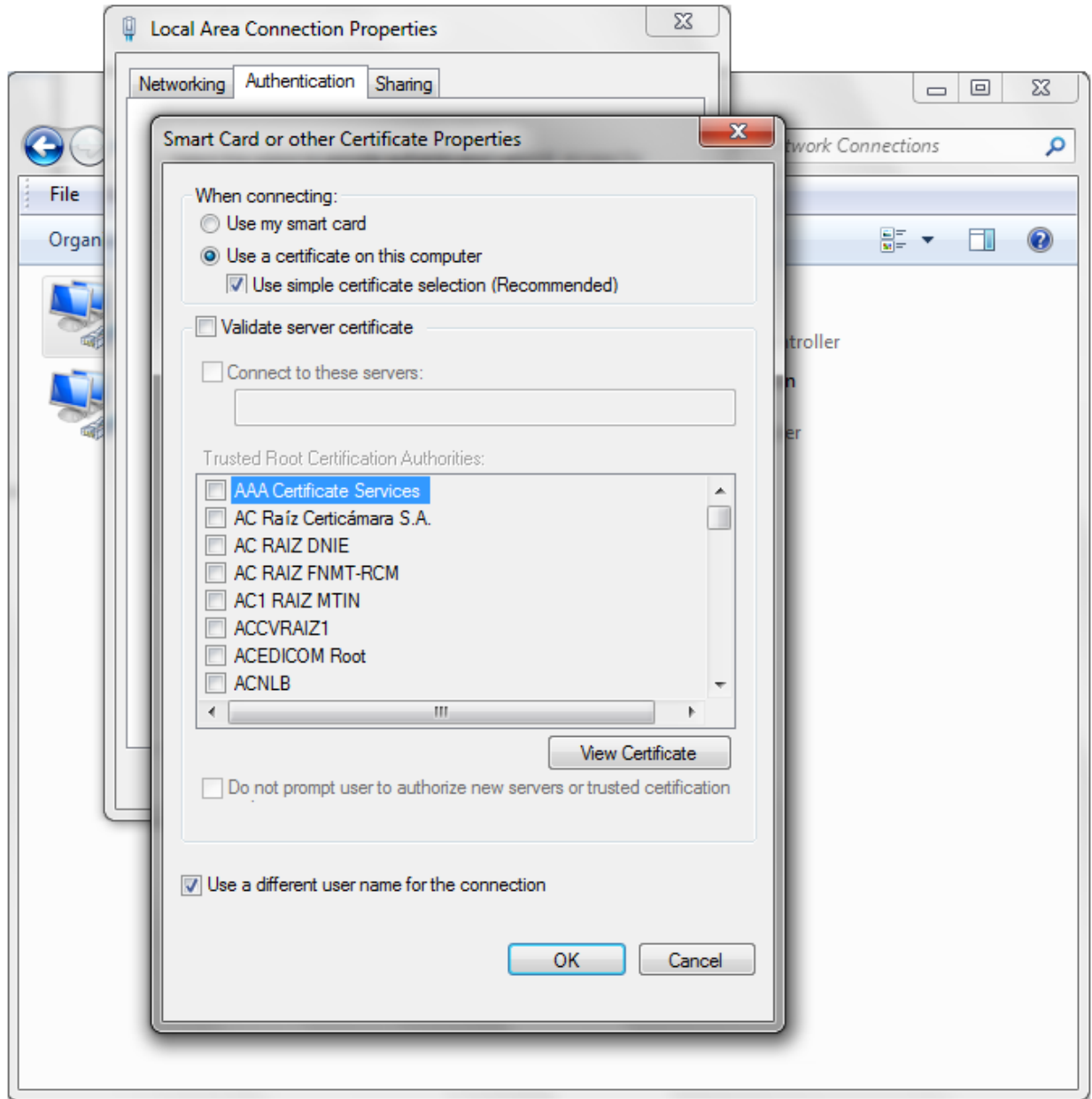
### 13.2.5 Windows configuration #2 - EAP-TLS mode

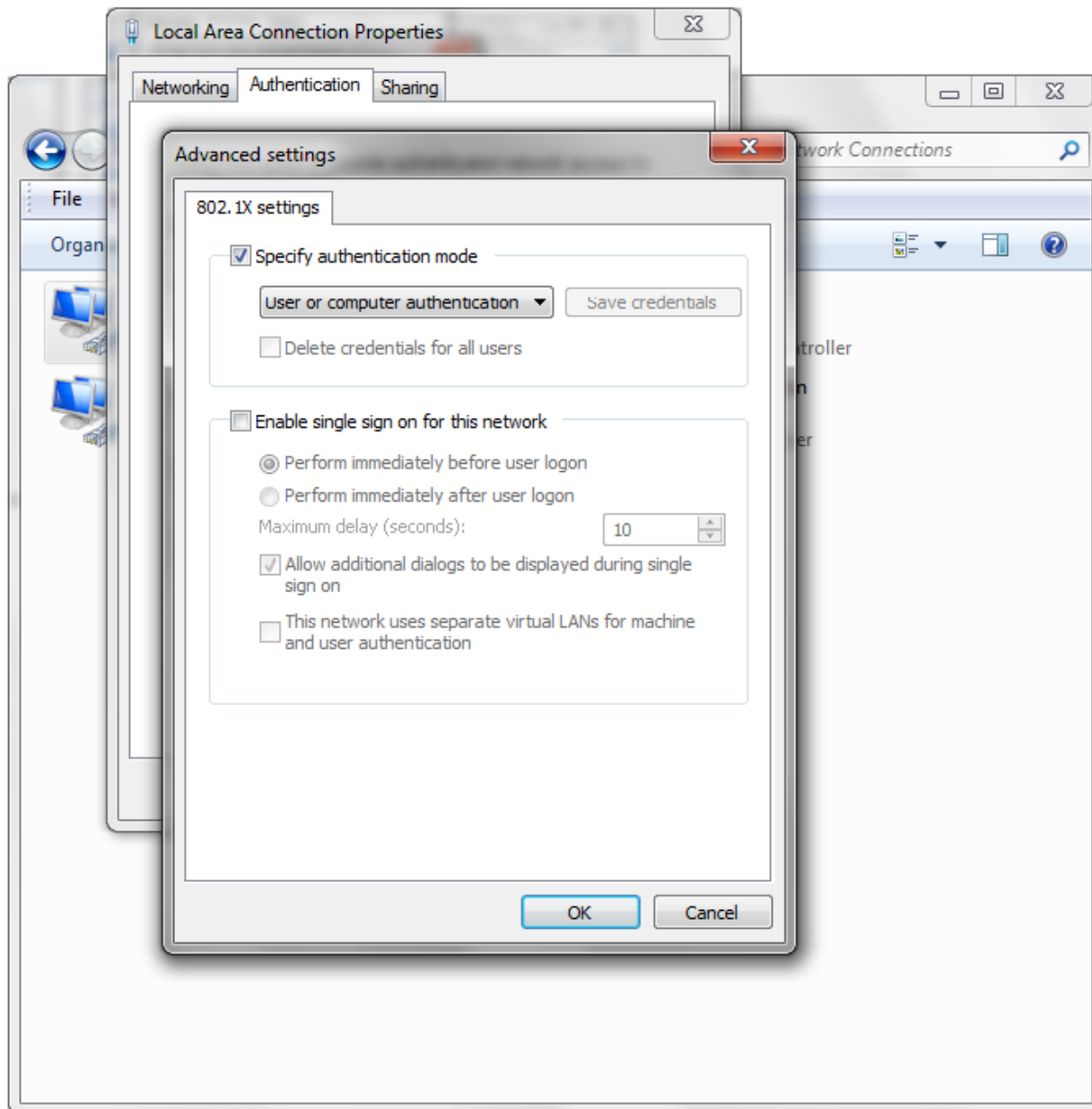
Following shows EAP-TLS mode on Windows with certificates. A certificate must be issued for the Windows peer. The client certificate and the issuing certificate can be imported using the **certmgr.msc** utility.



The wired interface is configured as shown in the next few diagrams on the following pages:

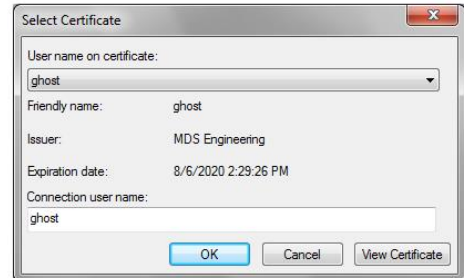
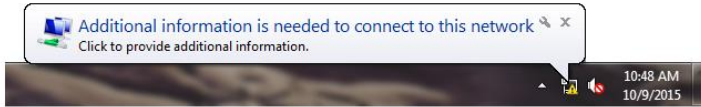




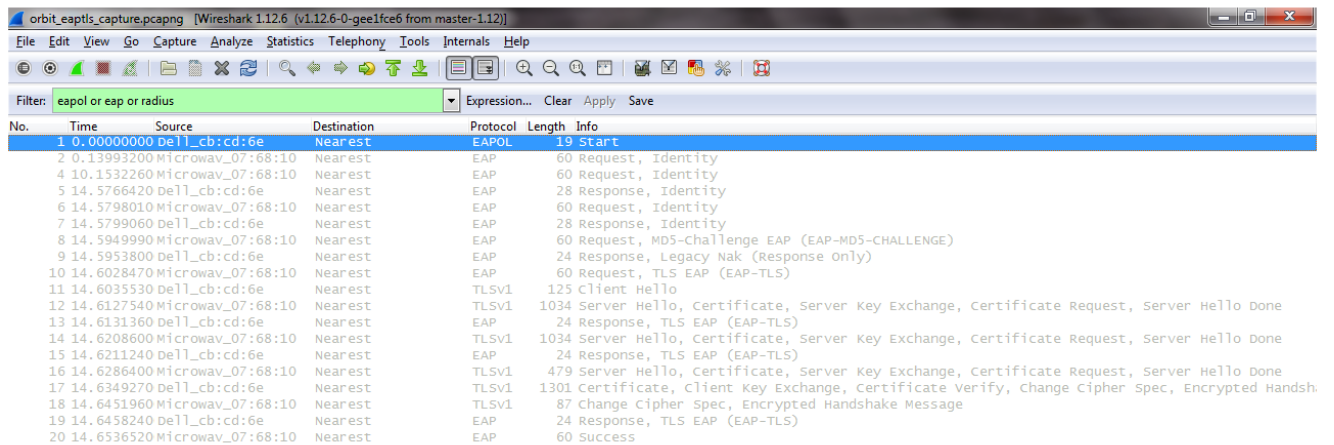




Connecting the Ethernet cable between the Orbit authenticator and Windows peer presents the following notification on Windows. Clicking the notification presents the certificate selection box where the imported certificate can be chosen.



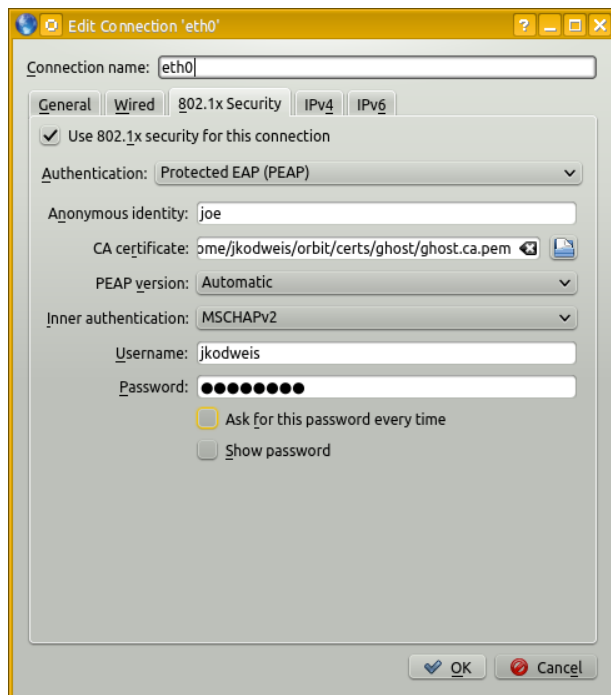
Running Wireshark in administrator mode on the Windows peer captures the EAP-TLS conversation between the Orbit and Windows. This tool can be used to diagnose communication errors on the peer.





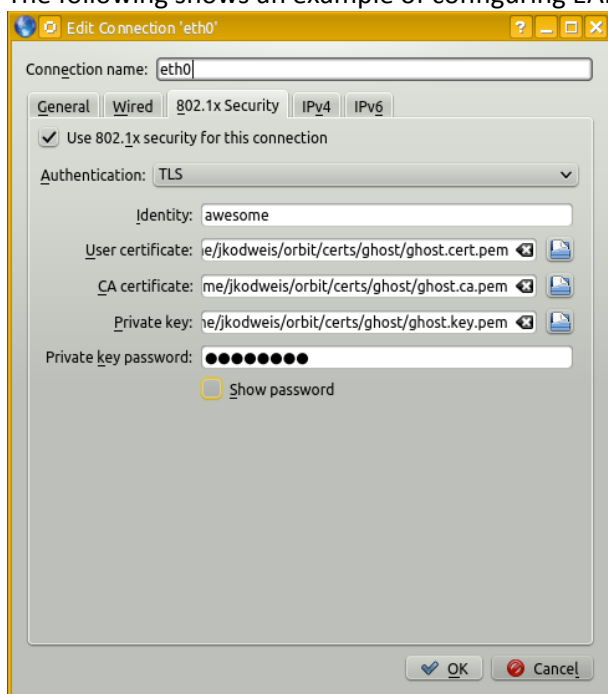
### 13.2.6 Kubuntu Linux configuration #1 – PEAP mode

The following shows an example of configuring PEAP mode on Kubuntu Linux. Unlike Windows, there is no need to start a service on this distribution. Also, this is no certificate import utility; the certificates can reside anywhere on the file system.



### 13.2.7 Kubuntu Linux configuration #2 – EAP-TLS mode

The following shows an example of configuring EAP-TLS mode on Kubuntu Linux.





## 13.2.8 Cisco switch as authenticator

The following configuration was used to evaluate behavior of another authenticator, ensuring the Orbit is compatible with established devices already being used in industry. A Cisco Catalyst 2960-S switch was used.

```
Switch#show configuration
Using 2061 out of 524288 bytes
!
version 12.2
no service pad
service timestamps debug datetime msec
service timestamps log datetime msec
no service password-encryption
hostname Switch
boot-start-marker
boot-end-marker
enable secret 5 $1$sP3l$MR/SumVvQhHlirgeef3gY0
username login privilege 15 nopassword
aaa new-model
aaa authentication dot1x default group radius
aaa authorization network default group radius
aaa authorization network mylist none
aaa session-id common
switch 1 provision ws-c2960s-24ts-1
dot1x system-auth-control
spanning-tree mode pvst
spanning-tree extend system-id
vlan internal allocation policy ascending
interface FastEthernet0
no ip address
interface GigabitEthernet1/0/1
switchport mode access
interface GigabitEthernet1/0/2
switchport mode access
authentication order dot1x
authentication port-control auto
dot1x pae authenticator
interface GigabitEthernet1/0/3
...
interface Vlan1
ip address 192.168.1.100 255.255.0.0
interface Vlan2
no ip address
ip http server
ip http secure-server
radius-server host 192.168.1.200 auth-port 1812 acct-port 1646
radius-server key password
line con 0
line vty 0 4
password cisco
line vty 5 15
password cisco
end

Switch#
```





## **14.0 APPENDIX H – Licenses**

### **14.1 Open Source License Declaration**

Orbit MCR products include Open Source Software. Usage is governed by the corresponding licenses which are listed on the GE MDS Industrial Wireless website, under Orbit MCR Software/Firmware Downloads, Support Items and download license-declaration-n\_n\_n.txt.


Upon request, in accordance with certain software license terms, GE will make available a copy of Open Source code contained in this product. This code is provided to you on an “as is” basis, and GE makes no representations or warranties for the use of this code by you independent of any GE provided software or services. For more information, contact [gemds.techsupport@ge.com](mailto:gemds.techsupport@ge.com)



## 15.0 APPENDIX I – Country Specific Information

The table below identifies any country-specific installation requirements or warning required by the country for the Orbit MCR. Operation of the unit must be in full compliance with all country and regional requirements.

**Table 15-1. Country-Specific Installation Data**

Country	Applicable Symbol(s)	Installation/Operating Requirements
Australia		For professional use only, not for sale to the general public. Hot surface—this product is only suitable for installation in restricted access locations.



---

# NOTES

---





## **IN CASE OF DIFFICULTY...**

---

Our products are designed for long life and trouble-free operation. However, this equipment, as with all electronic equipment, may have an occasional component failure. The following information will assist you in the event that servicing becomes necessary.

## **TECHNICAL ASSISTANCE**

---

Technical assistance for GE MDS products is available from our Technical Support Department during business hours (8:30 A.M.–6:00 P.M. Eastern Time). When calling, please give the complete model number of the product, along with a description of the trouble/symptom(s) that you are experiencing. In many cases, problems can be resolved over the telephone, without the need for returning the unit to the factory. Please use one of the following means for product assistance:

Phone: 585 241-5510    E-Mail: [gemds.techsupport@ge.com](mailto:gemds.techsupport@ge.com)  
FAX: 585 242-8369    Web: [www.gemds.com](http://www.gemds.com)

## **REPAIR SERVICE**

---

Component level repair of this equipment is not recommended in the field. Many components are installed using surface mount technology, which requires specialized training and equipment for proper servicing. For this reason, the equipment should be returned to the factory for any PC board repairs. The factory is best equipped to diagnose, repair and align your unit to its proper operating specifications.

If return of the equipment is necessary, you must obtain a return authorization number before shipment. This number helps expedite the repair so that the equipment can be returned to you as quickly as possible. Please be sure to include the number on the outside of the shipping box, and on any correspondence relating to the repair. No equipment will be accepted for repair without an authorization number.

Return authorization numbers are issued online at [www.gedigitalenergy.com/Communications.htm](http://www.gedigitalenergy.com/Communications.htm). On the left side of the page, click “Login to my MDS” and once logged in, click “Service Request Order”. Your number will be issued immediately after the required information is entered. Please be sure to have the model number(s), serial number(s), detailed reason for return, “ship to” address, “bill to” address, and contact name, phone number, and fax number available when requesting a number. A purchase order number or pre-payment will be required for any units that are out of warranty, or for product conversion.

If you prefer, you may contact our Product Services department to obtain an authorization number:

Telephone Number: 585-241-5540  
Fax Number: 585-242-8400  
E-mail Address: [gemds.productservices@ge.com](mailto:gemds.productservices@ge.com)

The radio must be properly packed for return to the factory. The original shipping container and packaging materials should be used whenever possible. All factory returns should be addressed to:

**GE MDS LLC  
Product Services Department  
(Auth. No. XXXX)  
175 Science Parkway  
Rochester, NY 14620 USA**

When repairs have been completed, the equipment will be returned to you by the same shipping method used to send it to the factory. Please specify if you wish to make different shipping arrangements. To inquire about an in-process repair, you may contact our Product Services department using the telephone, Fax, or E-mail information given above.

## **REPLACEMENT PARTS**

---

Many spare and replacement items are available for purchase by contacting your factory sales representative, or by visiting our online store at <http://store.gedigitalenergy.com/front.asp>



GE MDS, LLC  
175 Science Parkway  
Rochester, NY 14620  
Telephone: +1 585 242-9600  
FAX: +1 585 242-9620  
[www.gemds.com](http://www.gemds.com)

